

For Service Manuals Contact  
MAURITRON TECHNICAL SERVICES  
8 Cherry Tree Rd. Crinnor  
Clack. G60 4QY  
Tel: 01844-66161 Fax: 01844-352554  
Email: enquires@maurtron.co.uk

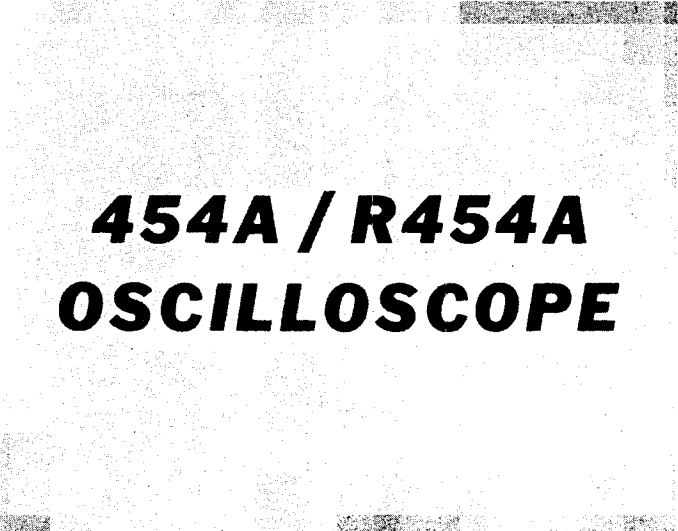

**454A / R454A  
OSCILLOSCOPE**

Tektronix, Inc. ● P.O. Box 500 ● Beaverton, Oregon 97005 ● Phone: 644-0161 ● Cables: Tektronix  
070-1074-00

171



## WARRANTY

All Tektronix instruments are warranted against defective materials and workmanship for one year.

Any questions with respect to the warranty, mentioned above, should be taken up with your Tektronix Field Engineer or representative.

All requests for repairs and replacement parts should be directed to the Tektronix Field Office or representative in your area. This procedure will assure you the fastest possible service. Please include the instrument Type (or Part Number) and Serial or Model Number with all requests for parts or service.

Specifications and price change privileges reserved.

Copyright © 1971 by Tektronix, Inc., Beaverton, Oregon. Printed in the United States of America. All rights reserved. Contents of this publication may not be reproduced in any form without permission of the copyright owner.

U.S.A. and foreign Tektronix products covered by U.S. and foreign patents and/or patents pending.

# TABLE OF CONTENTS

SECTION 1 454A SPECIFICATION	Page	Page	
Introduction	1-1	Loading Effect of the 454A	2-18
Table 1-1 Electrical		Ground Considerations	2-18
Vertical Deflection System	1-1	Input Coupling	2-18
Triggering (A and B Sweep)	1-4	Deflection Factor	2-18
Horizontal Deflection System	1-5	Probe Power Connectors	2-19
Delayed/Mixed Sweep	1-6	Dual-Trace Operation	2-19
X-Y Operation	1-7	Channel 1 Output and Cascaded Operation	2-19
Z Axis Input	1-7	Algebraic Addition	2-20
Calibrator	1-8	Trigger Source	2-20
Output Signals	1-8	Trigger Coupling	2-21
Power Supply	1-9	Trigger Slope	2-22
Cathode-Ray Tube (CRT)	1-10	Trigger Level	2-22
Table 1-2 Environmental	1-11	High-Frequency Stability	2-22
Table 1-3 Physical	1-12	A Sweep Triggered Light	2-22
Standard Accessories	1-12	A Sweep Mode	2-22
		Horizontal Sweep Rates	2-24
		Sweep Magnification	2-24
		B (Delayed Sweep)	2-25
		X-Y Operation	2-28
		Sweep Generator Output Signals	2-28
		Calibrator	2-29
		Applications	
		General	2-29
		Peak-To-Peak Voltage Measurements—AC	2-29
		Instantaneous Voltage Measurements—DC	2-30
		Comparison Measurements	2-31
		Time-Duration Measurements	2-33
		Frequency Measurements	2-33
		Risetime Measurements	2-34
		Time-Difference Measurements	2-35
		Delayed or Mixed Sweep Time Measurement	2-35
		Delayed or Mixed Sweep Magnification	2-36
		Pulse Jitter Measurements	2-38
		Delayed Trigger Generator	2-39
		Normal Trigger Generator	2-39
		Multi-Trace Phase Difference Measurements	2-39
		High Resolution Phase Measurements	2-40
		X-Y Phase Measurement	2-41
		Common-Mode Rejection	2-42
<b>SECTION 2 OPERATING INSTRUCTIONS</b>			
General	2-1		
Front Cover	2-1		
Operating Voltage	2-1		
Operating Temperature	2-2		
Operating Position	2-2		
Rackmounting	2-2		
Controls and Connectors			
General	2-2		
First-Time Operation			
General	2-8		
General Operating Information			
Simplified Operating Instructions	2-12		
Normal Sweep Display	2-12		
Magnified Sweep Display	2-12		
Delayed Sweep Display	2-13		
X-Y Display	2-13		
Intensity Control	2-13		
Astigmatism Adjustment	2-13		
Trace Alignment Adjustment	2-14		
Graticule	2-14		
Light Filter	2-14		
Beam Finder	2-14		
Bandwidth Limiter	2-15		
Vertical Channel Selection	2-15		
Vertical Gain Adjustment	2-15		
Step Attenuator Balance	2-16		
Signal Connections	2-16		

## **TABLE OF CONTENTS (cont)**

SECTION 3	CIRCUIT DESCRIPTION	Page	SECTION 5	CALIBRATION	Page
	Introduction	3-1		Introduction	5-1
	Block Diagram			Tektronix Field Service	5-1
	General	3-1		Using This Procedure	5-1
	Circuit Operation			Test Equipment Required	
	General	3-3		General	5-1
	Channel 1 Vertical Preamp	3-4		Special Calibration Fixtures	5-2
	Channel 2 Vertical Preamp	3-6		Calibration Equipment Alternatives	5-2
	Vertical Switching	3-7		Preliminary Control Settings	5-4
	Vertical Output Amplifier	3-10		Part I – Performance Check	
	Trigger Preamp	3-12		Introduction	5-5
	A Trigger Generator	3-14		Index of Part I – Performance Check	5-5
	A Sweep Generator	3-19		Preliminary Procedure for	
	B Trigger Generator	3-23		Performance Check	5-6
	B Sweep Generator	3-25		Display and Z Axis Check	5-7
	Horizontal Amplifier	3-28		Vertical System Check	5-9
	Low-Voltage Power Supply	3-31		Trigger System Check	5-15
	Voltage Distribution	3-34		Horizontal System Check	5-20
	Z Axis Amplifier	3-34		Output Signals Check	5-27
	CRT Circuit	3-36		Part II – Adjustment	
				Introduction	5-29
				Index of Part II – Adjustment	5-29
				Preliminary Procedure for	
				Adjustment	5-30
				Power Supply and Calibrator	
				Adjustment	5-31
				Display and Z Axis Adjustment	5-34
				Vertical System Adjustment	5-36
				Triggering Adjustment	5-44
				Horizontal System Adjustment	5-46
<b>SECTION 4</b>	<b>MAINTENANCE</b>		<b>SECTION 6</b>	<b>RACKMOUNTING</b>	
	Introduction	4-1		Introduction	6-1
	Cover Removal	4-1		Rack Dimensions	6-1
	Preventive Maintenance			Slide-Out Tracks	6-1
	General	4-1		Mounting Procedure	6-1
	Cleaning	4-1		Alternative Rear Mounting Methods	6-2
	Lubrication	4-2		Removing or Installing the	
	Visual Inspection	4-2		Instrument	6-3
	Transistor Checks	4-2		Slide-Out Track Lubrication	6-3
	Recalibration	4-2			
	Troubleshooting				
	Introduction	4-2			
	Troubleshooting Aids	4-2			
	Troubleshooting Equipment	4-4			
	Troubleshooting Techniques	4-5			
	Corrective Maintenance				
	General	4-7			
	Obtaining Replacement Parts	4-7			
	Component Replacement	4-10			
	Recalibration After Repair	4-14			

For Service Manuals Contact  
**MAURITRON TECHNICAL SERVICES**  
8 Cherry Tree Road, Chinnor  
Oxon OX9 3DY  
Tel: 01844-311971 Fax: 01844-352554  
Email: enquiries@mauritron.co.uk

## TABLE OF CONTENTS (cont)

SECTION 7 ELECTRICAL PARTS LIST	Page	SECTION 9 MECHANICAL PARTS LIST
Abbreviations and Symbols		Mechanical Parts List Information
Parts Ordering Information		Index of Mechanical Parts List and Illustrations
Index of Electrical Parts List		Mechanical Parts List
Electrical Parts List		
<b>SECTION 8 DIAGRAMS AND CIRCUIT BOARD ILLUSTRATIONS</b>		<b>CHANGE INFORMATION</b>
Symbols and Reference Designators	8-1	Abbreviations and symbols used in this manual are based on or taken directly from IEEE Standard 260 "Standard Symbols for Units", MIL-STD-12B and other standards of the electronics industry. Change information, if any, is located at the rear of this manual.
Voltage and Waveform Test Conditions	8-2	
Diagrams		
Circuit Board Illustrations		

For Service Manuals Contact  
**MAURITRON TECHNICAL SERVICES**  
 8 Cherry Tree Rd, Chinnor  
 Oxon OX9 4OY  
 Tel: 01844-351111, Fax: 01844-352554  
 Email: enquires@mauritron.co.uk

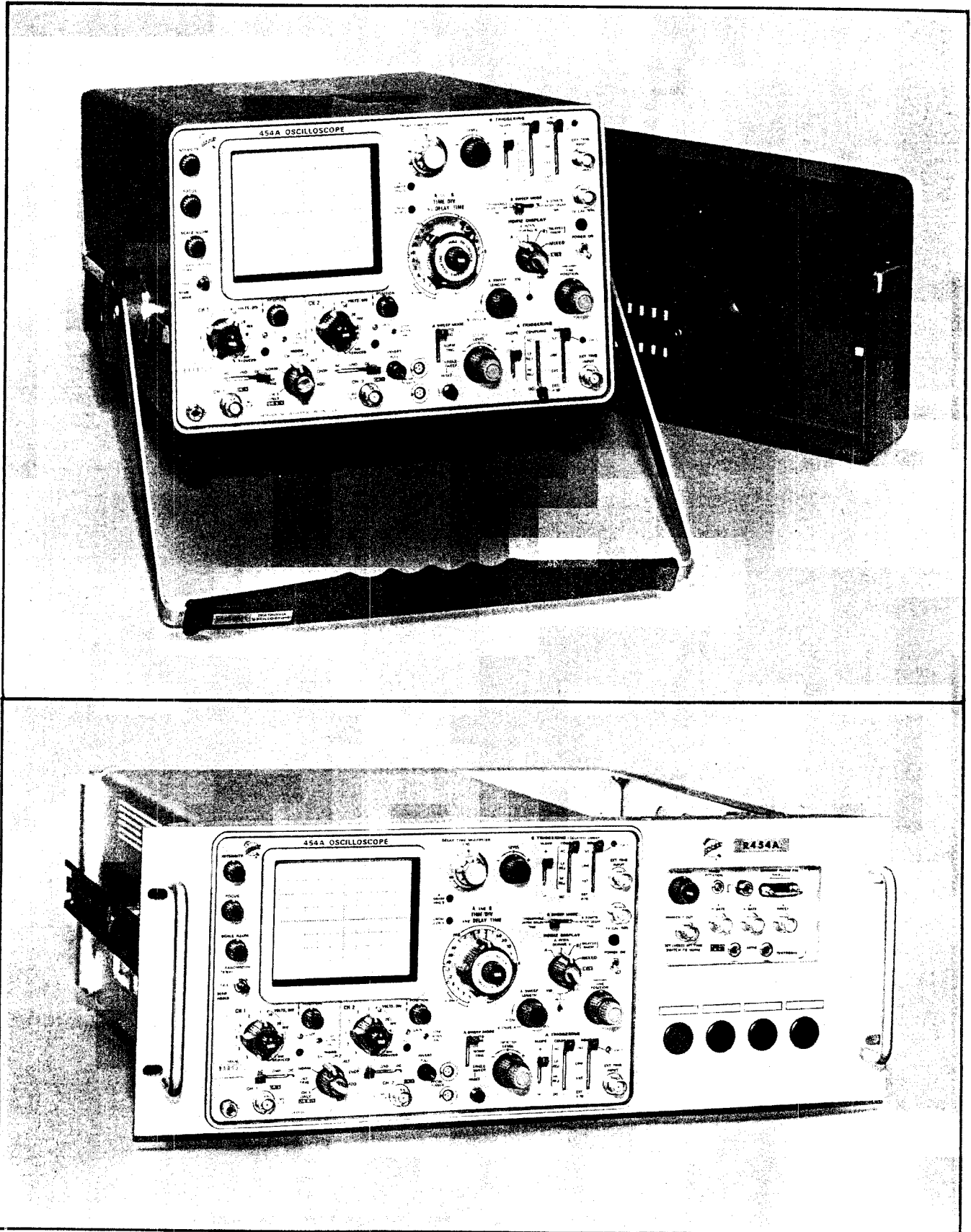

Fig. 1-1. Top; the 454A Oscilloscope. Bottom; the R454A Oscilloscope.

# SECTION 1

## 454A/R454A SPECIFICATION

Change information, if any, affecting this section will be found at the rear of this manual.

### Introduction

The Tektronix 454A Oscilloscope is a wide bandwidth, portable oscilloscope designed to operate in a wide range of environmental conditions. The light weight and compact design of the 454A allow it to be easily transported, while providing the performance necessary for accurate high-frequency measurements. The dual-channel, DC-to-150 megahertz vertical system provides calibrated deflection factors from 2 millivolts to 5 volts/division (bandwidth is reduced at the two lowest deflection factors). Channels 1 and 2 can be cascaded using an external cable to provide a 400 microvolt minimum deflection factor. A bandwidth limit switch allows low-frequency, low-level signals to be viewed with reduced interference from signals above about 20 megahertz.

The trigger circuits provide stable triggering over the full range of vertical bandwidth. Separate trigger controls are provided to select the desired triggering for the A and B sweeps. One of three sweep modes can be selected for A sweep; automatic triggering, normal triggering or single sweep. The horizontal deflection system provides calibrated sweep rates from five seconds to 0.02 microsecond/division. A X10 magnifier allows each sweep rate to be increased 10 times to provide a maximum sweep rate of two

nanoseconds/division in the .02  $\mu$ s position. The delayed and mixed sweep features allow the B Sweep to be delayed a selected amount from the start of A sweep to provide accurate relative-time measurements. Calibrated X-Y measurements can be made with Channel 2 providing the vertical deflection and Channel 1 providing the horizontal deflection (TRIGGER switch set to CH 1 ONLY, HORIZ DISPLAY switch set to X-Y). The regulated DC power supplies assure that instrument performance is not affected by variations in line voltage and frequency. Total power consumption of the instrument is about 115 watts.

Information given in this instruction manual applies to the R454A also unless otherwise indicated. The R454A is electrically identical to the 454A, but it is adapted for mounting in a standard 19-inch rack. Rackmounting instructions and a dimensional drawing are given in section 6.

This instrument will meet the electrical characteristics listed in Table 1-1 following complete calibration as given in section 5. The following electrical characteristics apply over a calibration interval of 1000 hours and an ambient temperature range of  $-15^{\circ}\text{C}$  to  $+55^{\circ}\text{C}$ , except as otherwise indicated. Warm-up time for given accuracy is 20 minutes.

TABLE 1-1  
ELECTRICAL

Characteristic	Performance	Supplemental
<b>VERTICAL DEFLECTION SYSTEM</b>		
Deflection Factor Channel 1 and 2 Calibrated Range	Two millivolts/division to five volts/division in eleven steps in a 1-2-5 sequence.	<p><b>For Service Manuals Contact</b>  <b>MAURITRON TECHNICAL SERVICES</b>            8 Cherry Tree Rd, Chinnor            Oxon OX9 4QY            Tel: 01844-352554            Email: enquiries@mauritron.co.uk</p>
Added Mode Calibrated Range	Between two millivolts/division and five volts/division.	
Channel 1 or 2, or Added Mode Accuracy (With or Without P6054 Probe)	Within 3% of indicated deflection with GAIN correctly adjusted at 20 mV/div.	

TABLE 1-1 (cont)

Characteristic	Performance	Supplemental
<b>VERTICAL DEFLECTION SYSTEM (cont)</b>		
Uncalibrated (Variable) Range	Provides continuously variable deflection factors between the calibrated steps. Extends maximum uncalibrated deflection factor to at least 12.5 volts/division.	At least 2.5:1.
Maximum Risetime and Minimum Bandwidth at Upper -3 dB Point AC (capacitive) and DC (direct) Coupled, Four-Division Reference, 25-ohm Source Impedence (0°C to +40°C)	See Table 1-1A.	
Bandwidth at Lower -3 dB Point, AC (capacitive) Coupled, Four-Division Reference Without Probe	10 Hz or less at all deflection factors.	
With P6054	1 Hz or less at all deflection factors.	
Bandwidth at Upper -3 dB Point, DC (direct) Coupled, Four Division Reference, With BANDWIDTH-BEAM FINDER Switch in 20 MHz Position	Approximately 20 MHz.	-3 dB point between 16 MHz and 24 MHz.
Attenuation ratio of signal at 100 MHz.	At least 30:1.	
Vertical Display Modes	Channel 1 Only Channel 2 Only Dual-Trace, alternate between channels. Dual-Trace, chop between channels Added algebraically	
Input Coupling Modes	AC (capacitive) coupled or DC (direct) coupled.	
Common-Mode Rejection Ratio AC and DC Coupled	At least 20:1 at 20 MHz for common mode signals 80 mV peak to peak in the 10 mV/div position of the VOLTS/DIV switches with GAIN adjustment optimized using a 50 kHz signal in the 10 mV/div position of the VOLTS/DIV switches.	



TABLE 1-1 (cont)

Characteristic	Performance	Supplemental
<b>VERTICAL DEFLECTION SYSTEM (cont)</b>		
Maximum Safe Input Voltage All V/DIV Settings	500 volts DC + peak AC (one kilohertz or less).	
Input RC Characteristics		
Resistance	1 megohm $\pm$ 2%	
Capacitance	Approximately 15 picofarads	
Step Attenuator Balance		Adjustable for 0 trace shift when deflection factor is changed from 2 mV/div to 10 mV/div.
Inter-Channel Isolation		
Attenuator		At least 10,000:1 at 50 MHz.
Amplifier	At least 100:1 at 50 MHz.	
Chopped Mode		
Chopped Repetition Rate	Approximately 1 MHz	
Time Segment From Each Channel	400 nanoseconds to 650 nanoseconds.	
Polarity Inversion	Display signal from Channel 2 can be inverted.	For Service Manuals Contact MAURITRON TECHNICAL SERVICES 8 Charnock Road, Chinnor Oxford OX9 4QY Tel: 01844-352554 Fax: 01844-352554 Email: enquiries@mauritron.co.uk

TABLE 1-1A

Minimum Bandwidth and Maximum Risetime  
(0°C to +40°C)

Deflection Factor	With 3.5 ft. or 6 ft. P6054 or 25 ohm source	With 9 ft. P6054	With P6045	With P6048
2 mV/div	50 MHz 7.0 nanoseconds	48 MHz 7.3 nanoseconds	45 MHz 7.8 nanoseconds	45 MHz 7.8 nanoseconds
5 mV/div	100 MHz 3.5 nanoseconds	87 MHz 4.0 nanoseconds	95 MHz 3.7 nanoseconds	75 MHz 4.7 nanoseconds
10 mV/div to 5 V/div	150 MHz 2.4 nanoseconds	116 MHz 3.0 nanoseconds	130 MHz 2.7 nanoseconds	100 MHz 3.5 nanoseconds
400 $\mu$ V/div (Channels 1 and 2 cascaded) <sup>1</sup>	33 MHz 11 nanoseconds	32 MHz 11.5 nanoseconds	30 MHz 12 nanoseconds	30 MHz 12 nanoseconds

<sup>1</sup> Cascaded (CH 1 OUT into CH 2) using 50  $\Omega$  18-inch RG 38 A/U cable; with CH 1 and CH 2 deflection factors set at 2 mV/DIV, unterminated and TRIGGER switch set to NORM. 400  $\mu$ V/div is a minimum deflection factor for this mode, not a calibrated deflection factor.

TABLE 1-1 (cont)

Characteristic	Performance	Supplemental
<b>TRIGGERING (A AND B SWEEP)</b>		
Trigger Source	Internal from displayed channel(s) or from Channel 1 only. Internal from AC power source. External from signal applied to EXT TRIG INPUT connector. External from signal applied to EXT TRIG INPUT connector attenuated 10 times.	
Trigger Coupling	AC AC low-frequency reject AC high-frequency reject DC	
Trigger Sensitivity	See Fig. 1-2.	
Auto Triggering (A Sweep only)	Stable display presented with signal amplitudes given in Fig. 1-2 above about 20 hertz. Presents a free-running display for lower frequencies or absence of an adequate trigger signal.	
Single Sweep (A sweep only)	A Sweep Generator produces only one sweep when triggered. Further sweeps are locked out until RESET button is pressed.	

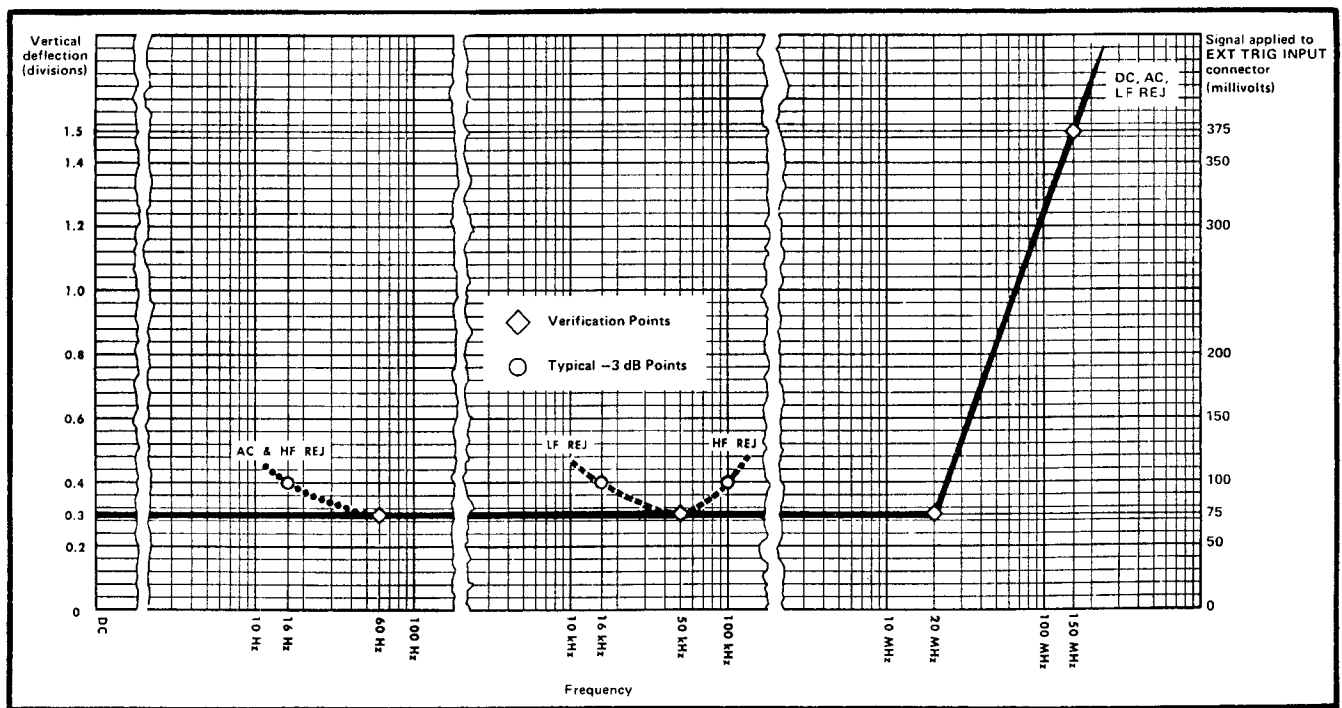

Fig. 1-2. Trigger sensitivity specification limit curve.

TABLE 1-1 (cont)

Characteristic	Performance	Supplemental
<b>TRIGGERING (cont)</b>		
Trigger Jitter	0.4 nanosecond or less.	
External Trigger Input Maximum Input Voltage	500 volts DC + peak AC (one kilohertz or less). 500 volts peak to peak AC.	
RC Characteristics	1 megohm $\pm 10\%$ paralleled by approximately 15 picofarads, except when the COUPLING switches are in the LF REJ positions. See Fig. 1-3.	
LEVEL Control Range EXT	+ and - 2 volts or greater.	
EXT $\div 10$	+ and - 20 volts or greater.	

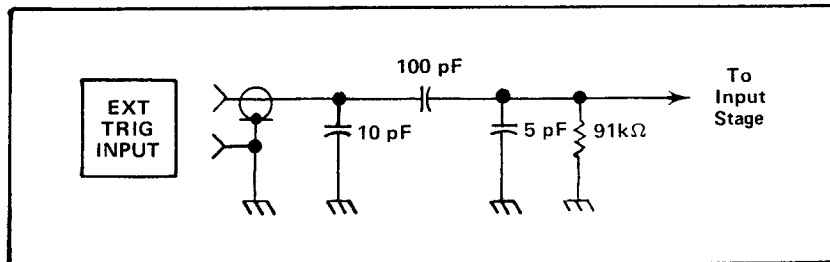

Fig. 1-3. Equivalent EXT TRIG INPUT circuit in AC LF REJ position of COUPLING switches.

**HORIZONTAL DEFLECTION SYSTEM**

Sweep Mode (A sweep only)	Normal Automatic Single Sweep	
Calibrated Sweep Rates A Sweep	0.02 microsecond to 5 seconds/ division in 26 steps in a 1-2-5 sequence.	<p><b>For Service Manuals Contact</b>  <b>MAURITRON TECHNICAL SERVICES</b>                      8 Cherry Tree Rd. Chinnor                      Oxon OX9 4QY                      Tel: 01844 331394 Fax: 01844-352554                      Email: enquiries@mauritron.co.uk</p>
B (Delayed) Sweep	0.02 microsecond to .5 second/ division in 23 steps in a 1-2-5 sequence.	
Sweep Accuracy	See Table 1-1B.	

TABLE 1-1 (cont)

Characteristic	Performance	Supplemental
<b>HORIZONTAL DEFLECTION SYSTEM (cont)</b>		
Uncalibrated (variable) Sweep Rates	Provides continuously variable sweep rates between the calibrated steps. Extends the slowest uncalibrated sweep rate to at least 12.5 seconds/division for A sweep or 1.25 seconds/division for B sweep.	At least 2.5:1.

TABLE 1-1B  
Sweep Accuracy

A and B TIME/DIV switch setting	0°C to +40°C		-15°C to +55°C	
	Unmagnified	Magnified <sup>2</sup>	Unmagnified	Magnified <sup>2</sup>
Over center eight divisions 5 s to 0.1 s/DIV (A sweep only)	Within 3%	Within 6%	Within 5%	Within 8%
50 ms to 1 μs/DIV		Within 4%	Within 4%	Within 5%
0.5 μs/DIV to 0.02 μs/DIV			Within 4%	Within 6/
Over any two division portion within center eight divisions (all sweep rates)	Within 5%	Within 5%	Within 5%	Within 10%

<sup>2</sup>Exclude the following portions of the magnified sweep from 2 ns/div to 20 ns/div (equivalent magnified sweep rates):

- 2 ns/div                      First 25 divisions and all beyond the 100<sup>th</sup> division.
- 5 ns/div                      First 10 divisions and all beyond the 100<sup>th</sup> division.
- 10 ns/div                     First 5 divisions and all beyond the 100<sup>th</sup> division.
- 20 ns/div                     First 2.5 divisions and all beyond the 100<sup>th</sup> division.

**DELAYED/MIXED SWEEP**

Calibrated Delay Time	Continuous from 50 seconds to 0.02 microsecond.		
Delay Time Accuracy Over The Center Eight Divisions	0°C to +40°C	-15°C to +55°C	
	5 s/div to 0.1 s/div	Within 2.5%	Within 3.5%
50 ms/div to 0.1 μs/div	Within 1.5%	Within 2%	

TABLE 1-1 (cont)

Characteristic	Performance	Supplemental
<b>DELAYED/MIXED SWEEP (cont)</b>		
Multiplier Linearity	Within 0.2% of full scale (two) minor divisions).	
Delay Time Jitter	One part or less in 20,000 of 10X the TIME/DIV setting.	
Differential Time Measurement Accuracy	Within 1.5% and 4 minor dial divisions for delay times 0.1 $\mu$ s to 50 ms. Within 2.5% and 4 minor dial divisions for delay times 0.1 second to 5 seconds.	
Mixed Sweep Accuracy	Within 2% plus the measured A sweep error when viewing A Sweep portion only. B Sweep portion retains same accuracy as stated for B (Delayed Sweep).	

**X-Y OPERATION**

Deflection Factor Calibrated Range	See Vertical Deflection System characteristics.	
Accuracy		
X and Y Input RC Characteristics	See Vertical Deflection System characteristics.	
X Bandwidth at Upper -3 dB Point	At least 2 MHz.	
Phase Shift Between Channel 1 (X) and Channel 2 (Y)	3° or less from DC to 2 MHz.	<p style="text-align: right;"><b>For Service Manuals Contact</b>  <b>MAURITRON TECHNICAL SERVICES</b>  8 Church Lane, Chinnor  Oxon OX4 4DY  Tel: 01844-35100 Fax: 01844-352554  Email: enquiries@mauritron.co.uk</p>

**Z AXIS INPUT**

Sensitivity	Five volt peak to peak signal produces noticeable modulation at normal intensity.	
Input Coupling	DC (direct) coupled.	
Polarity of Operation		Positive-going input signal decreases trace intensity; Negative-going signal increases trace intensity.
Usable Frequency Range	From DC to 50 MHz.	

TABLE 1-1 (cont)

Characteristic	Performance	Supplemental
<b>Z AXIS INPUT (cont)</b>		
Maximum Input Voltage	200 volts DC plus peak AC (one kilohertz or less).	
Input Resistance		Approximately 47 kilohms at DC.

**CALIBRATOR**

Waveshape		Squarewave	
Polarity		Positive-going with baseline at zero volts.	
Output Voltage	One volt peak to peak.		
Output Current	Five milliamperes through the CURRENT PROBE CAL loop on the instrument side panel.		
Repetition Rate	One kilohertz		
Risetime	One microsecond or less.		
Accuracy	0°C to +40°C	-15°C to +55°C	
	Voltage	Within 1%	Within 1.5%
	Current	Within 1%	Within 1.5%
	Repetition Rate	Within 0.5%	Within 1%
Duty Cycle		49% to 51%.	
Output Resistance		250 Ω within 1%	

**OUTPUT SIGNALS**

A Sweep		
Waveshape	Sawtooth	
Amplitude	Approximately 10 volts.	Within 10%.
Polarity	Positive-going.	
Duration	Same as A sweep (variable with the A SWEEP LENGTH control).	
Output Resistance		Approximately 330 ohms.

TABLE 1-1 (cont)

Characteristic	Performance	Supplemental
<b>OUTPUT SIGNALS (cont)</b>		
A and B + Gates		
Waveshape	Rectangular pulse	
Amplitude	Approximately 12 volts.	12.6 volts within 10%.
Polarity	Positive-going	
Duration	Same duration as respective sweep.	
Output Resistance		A Gate: approximately 330 ohms B Gate: approximately 1 kilohm
Vertical Signal Out (CH 1 Only)		
Output Voltage	10 millivolts, or greater, per division of CRT display into a one megohm load.	
Bandwidth at Upper -3 dB Point, DC (direct) Coupled	DC to at least 50 MHz.	
DC Level		Adjustable to 0 volts within 8 mV.
Output Coupling	DC (direct) coupled.	
<b>POWER SUPPLY</b>		
Line Voltage	115 volts nominal and 230 volts nominal.	
Voltage Range (AC, RMS)		
115 Volts Nominal		
Low	90 to 110 volts.	
Medium	104 to 126 volts.	
High	112 to 136 volts.	
230 Volts Nominal		
Low	180 to 220 volts.	
Medium	208 to 252 volts.	
High	224 to 272 volts.	
Line Frequency	48 to 62 Hz.	
Maximum Power Consumption	116 watts at 115 volts, 60 Hz line.	

For Service Manuals Contact  
**MAURITRON TECHNICAL SERVICES**  
 8 Cherry Tree Road, Chinnor  
 Oxon OX9 4QY  
 Tel: 01844 894100 Fax: 01844 352554  
 Email: enquires@mauritron.co.uk

TABLE 1-1 (cont)

Characteristic	Performance	Supplemental
<b>CATHODE-RAY TUBE (CRT)</b>		
Graticule Type	Internal	
Area	Eight divisions vertical by 10 divisions horizontal. Each division equals 0.8 centimeter.	
Resolution Horizontal	15 lines or greater in one division.	
Vertical	15 lines or greater in one division.	
Geometry	0.1 division or less.	
Beam Finder	Limits display within graticule area when pressed.	
Trace Rotation Range		At least 5.4°.
Photographic Writing Speed C31 Camera with <i>f</i> 1.2 Lens and 1:0.5 Object-To-Image Ratio	At least 1600 divisions/ $\mu$ s (1280 cm/ $\mu$ s) with Polaroid Type 410 film (10,000 ASA) and Type P31 CRT phosphor. At least 3200 divisions/ $\mu$ s (2560 cm/ $\mu$ s) with Polaroid Type 410 film (10,000 ASA) and Type P11 CRT phosphor.	
C30 Camera with <i>f</i> 1.9 Lens and 1:0.7 Object-To-Image Ratio	At least 182 divisions/ $\mu$ s (146 cm/ $\mu$ s) with Polaroid type 107 film (10,000 ASA) and Type P31 CRT phosphor.	
C40 Camera With <i>f</i> 1.3 Lens and 1:0.5 Object-To-Image Ratio	At least 1250 divisions/ $\mu$ s (1000 cm/ $\mu$ s) with Polaroid type 410 film (10,000 ASA) and Type P31 CRT phosphor. At least 2500 divisions/ $\mu$ s (2000 cm/ $\mu$ s) with Polaroid type 410 film (10,000 ASA) and Type P11 CRT phosphor.	



TABLE 1-2  
ENVIRONMENTAL

Characteristic	Performance	Supplemental
Temperature Operating	-15°C to +55°C	Fan at rear circulates air throughout instrument. Automatic resetting thermal cutout protects instrument from overheating.
Non-Operating	-55°C to +75°C	For instruments equipped with running time meters, derate non-operating low temperature to -30°C.
Electromagnetic Interference (MOD163D Only) As Tested In MIL-I-6181D		
Radiated Interference	Radiated Interference from the instrument under test within the given limits from 150 kHz to 1000 MHz.	
Conducted Interference	Conducted interference through the power cord within the given limits from 150 kHz to 25 MHz.	
Transportation	Qualified under National Safe Transit Committee test procedure 1A with a 30-inch drop.	
Altitude Operating	To 15,000 feet. Maximum allowable ambient temperature decreased by 1°C/1000 feet from 5,000 feet to 15,000 feet.	
Non-Operating	To 50,000 feet.	
Humidity Operating and Storage	5 cycles (120 hours) to 95% relative humidity referenced to MIL-E-16400 F.	For Service Manuals Contact MAURITRON TECHNICAL SERVICES 8 Cherry Tree Rd. Chinnor Oxon OX9 3QY Tel:- 01844-351204 Fax:- 01844-352554 Email:- enquiries@mauritron.co.uk
Vibration Operating	Fifteen minutes along each of the three major axes at a total displacement of 0.025 inch peak to peak (4 g's at 55 Hz) with frequency varied from 10 to 55 Hz in one minute sweeps. Hold for 3 minutes at 55 Hz. All major resonances must be above 55 Hz.	
Shock Operating and Non-Operating	30 g's, 1/2 sine, 11 ms duration, 2 shocks per axis each direction for a total of 12 shocks.	

TABLE 1-3  
PHYSICAL

Characteristic	Information
Construction	
Chassis	Aluminum alloy
Panel	Aluminum alloy with anodized finish.
Cabinet	Blue vinyl-coated aluminum (anodized aluminum on R454A).
Circuit Boards	Glass-epoxy laminate.
Overall Dimensions, 454A (measured at maximum points)	
Height	7.2 inches.
Length	20.7 inches (includes front cover); 22.4 inches with handle positioned for carrying
Width	12.6 inches.
Overall dimensions, R454A (measured at maximum points)	
Height	7 inches.
Length	18 inches behind front panel; 19.8 inches overall.
Width	19 inches.

Characteristic	Information
Connectors	
Z AXIS INPUT	Binding Post.
PROBE POWER	Special three-pin connector compatible with power connector of the Tektronix P6045 Probe.
All Other Connectors	BNC.
Net Weight	
454A	Approximately 30 pounds.
R454A	Approximately 33.5 pounds.

STANDARD ACCESSORIES

Standard accessories supplied with the 454A and R454A are listed in the Mechanical Parts List. For optional accessories available for use with this instrument, see the current Tektronix, Inc. catalog.

# SECTION 2

## OPERATING INSTRUCTIONS

*Change information, if any, affecting this section will be found at the rear of this manual.*

### General

To effectively use the 454A, the operation and capabilities of the instrument must be known. This section describes the operation of the front-, side- and rear-panel controls and connectors, gives first and general operating information and lists some basic applications for this instrument.

### Front Cover

The front cover furnished with the 454A provides a dust-tight seal around the front panel. Use the cover to protect the front panel when storing or transporting the instrument. The cover also provides storage space for probes and other accessories (see Fig. 2-1).

### Operating Voltage

**CAUTION**

*This instrument is designed for operation from a power source with its neutral at or near earth (ground) potential with a separate safety-earth conductor. It is not intended for operation from two phases of a multi-phase system, or across the legs of a single-phase, three-wire system.*

The 454A can be operated from either a 115-volt or a 230-volt nominal line voltage source. The Line Voltage Selector assembly on the rear panel converts the instrument from one operating range to the other. In addition, this assembly changes the primary connections of the power transformer to allow selection of one of three regulating ranges. The assembly also includes the two line fuses. When the instrument is converted from 115-volt to 230-volt nominal operation or vice versa, the assembly connects or disconnects one of the fuses to provide the correct protection for the instrument. Use the following procedure to convert this instrument between nominal line voltages or regulating ranges.

1. Disconnect the instrument from the power source.
2. Loosen the two captive screws which hold the cover onto the voltage selector assembly; then pull to remove the cover.



Fig. 2-1. Accessory storage provided in front cover.

3. To convert from 115-volts nominal to 230-volts nominal line voltage or vice versa, pull out the Voltage Selector switch bar (see Fig. 2-2); turn it 180° and plug it back into the remaining holes. Change the line-cord power plug to match the power-source receptacle or use a 115- to 230-volt adapter.

#### NOTE

*Color-coding of the cord conductors is as follows (in accordance with National Electrical Code):*

Line	Black
Neutral	White
Safety earth (ground)	Green

4. To change regulating ranges, pull out the Range Selector switch bar (see Fig. 2-2); slide it to the desired position and plug it back in. Select a range which is centered about the average line voltage to which the instrument is to be connected (see Table 2-1).

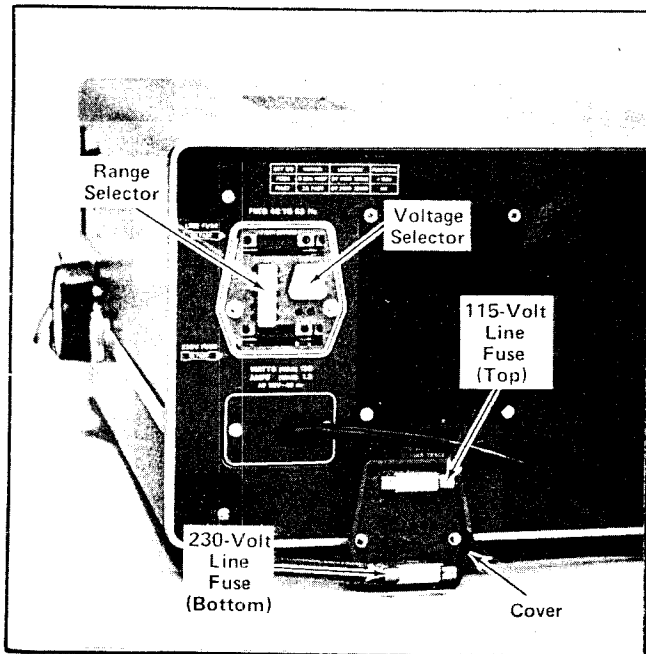

Fig. 2-2. Line Voltage Selector assembly on the rear panel (shown with cover removed).

TABLE 2-1  
Regulating Ranges

Range Selector Switch Position	Regulating Range	
	115 Volts Nominal	230 Volts Nominal
LO (switch bar in left holes)	90 to 110 volts	180 to 220 volts
M (switch bar in middle holes)	104 to 126 volts	208 to 252 volts
HI (switch bar in right holes)	112 to 136 volts	224 to 272 volts

5. Re-install the cover and tighten the two captive screws.

6. Before applying power to the instrument, check that the indicating tabs on the switch bars are protruding through the correct holes for the desired nominal line voltage and regulating range.



*This instrument may be damaged if operated with the Line Voltage Selector assembly set to incorrect positions for the line voltage applied.*

The 454A is designed to be used with a three-wire AC power system. If the three- to two-wire adapter is used to

connect this instrument to a two-wire AC power system, be sure to connect the ground lead of the adapter to earth (ground). Failure to complete the ground system may allow the chassis of this instrument to be elevated above ground potential and pose a shock hazard.

### Operating Temperature

The 454A is cooled by air drawn in at the rear and blown out through holes in the top and bottom covers. Adequate clearance on the top, bottom and rear must be provided to allow heat to be dissipated away from the instrument. The clearance provided by the feet at the bottom and rear should be maintained. If possible, allow about one inch clearance on the top. Do not block or restrict the air flow from the air escape holes in the cabinet.

A thermal cutout in this instrument provides thermal protection and disconnects the power to the instrument if the internal temperature exceeds a safe operating level. Operation of the instrument for extended periods without the covers may cause it to overheat and the thermal cutout to open more frequently. The air filter should be cleaned occasionally to allow the maximum amount of cooling air to enter the instrument. Cleaning instructions are given in Section 4.

The 454A can be operated where the ambient air temperature is between  $-15^{\circ}\text{C}$  and  $+55^{\circ}\text{C}$ . The maximum operating temperature must be derated  $1^{\circ}\text{C}$  for each additional 1000 feet of altitude above 5000 feet. This instrument can be stored in ambient temperatures between  $-35^{\circ}\text{C}$  and  $+75^{\circ}\text{C}$ . After storage at temperatures beyond the operating limits, allow the chassis temperature to come within the operating limits before power is applied.

### Operating Position

The handle of the 454A can be positioned for carrying or as a tilt-stand for the instrument. To position the handle, press in at both pivot points (see Fig. 2-3) and turn the handle to the desired position. Fourteen positions are provided for convenient carrying or viewing. The instrument may also be set on the rear feet either for operation or storage.

### Rackmounting

Complete information for mounting the R454A in a cabinet rack is given in Section 6 of this manual.

## CONTROLS AND CONNECTORS

### General

A brief description of the function and operation of the front-, side- and rear-panel controls and connectors follows.

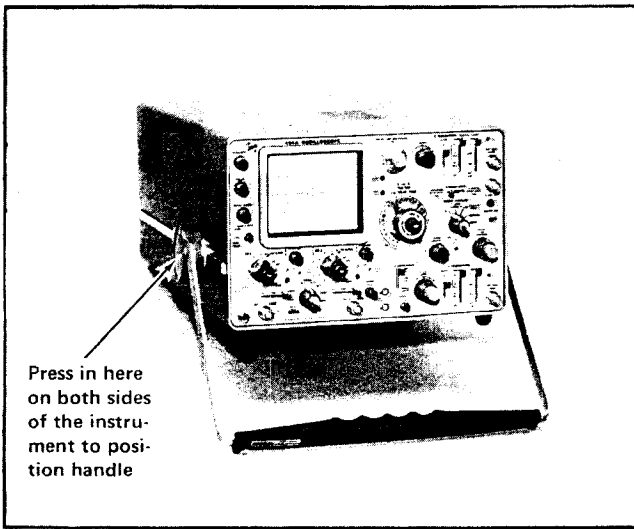

Fig. 2-3. Handle positioned to provide a stand for the instrument.

Fig. 2-4 shows the front, side and rear panels of this instrument. More detailed information is given in this section under General Operating Information.

**Cathode-Ray Tube**

- INTENSITY** Controls brightness of display.
- FOCUS** Provides adjustment for optimum display definition.
- SCALE ILLUM** Controls graticule illumination.
- BANDWIDTH-BEAM FINDER** Three position switch which provides bandwidth limiting and beam location.
  - 20 MHz:** Vertical Amplifier bandwidth limited to provide a reduction in displayed noise or interference.
  - FULL:** Normal operation with full Vertical Amplifier bandwidth capabilities.
  - BEAM FINDER:** Compresses display within graticule area, independently of display position or applied signals.

**Vertical (both channels except as noted)**

- VOLTS/DIV** Selects vertical deflection factor in 1-2-5 sequence (VARIABLE control must be in CAL position for indicated deflection factor).
- VARIABLE** Provides continuously variable uncalibrated deflection factors between the calibrated settings of the VOLTS/DIV switch.
- UNCAL** Light indicates that the VARIABLE control is not in the CAL position.
- STEP ATTEN BAL** Screwdriver adjustment to balance Input Amplifier in the 2, 5 and 10 mV positions of the VOLTS/DIV switch.
- POSITION** Controls vertical position of trace. In X-Y mode of operation, CH 1 control positions in the X-axis (horizontally) and CH 2 control positions in the Y-axis (vertically).
- GAIN** Screwdriver adjustment to set gain of the Vertical Preamp.
- Input Coupling (AC-GND-DC)** Selects method of coupling input signal to Input Amplifier.
  - AC:** DC component of input signal is blocked. Low frequency limit (-3 dB point) is about 10 hertz.
  - GND:** Input circuit is grounded (does not ground applied signal).
  - DC:** All components of the input signal are passed to the Input Amplifier.
- PROBE POWER** Power source for active probe systems.
- INPUT CH 1 OR X** Input connector for CH 1 deflection signals or X-axis deflection in the X-Y mode of operation.

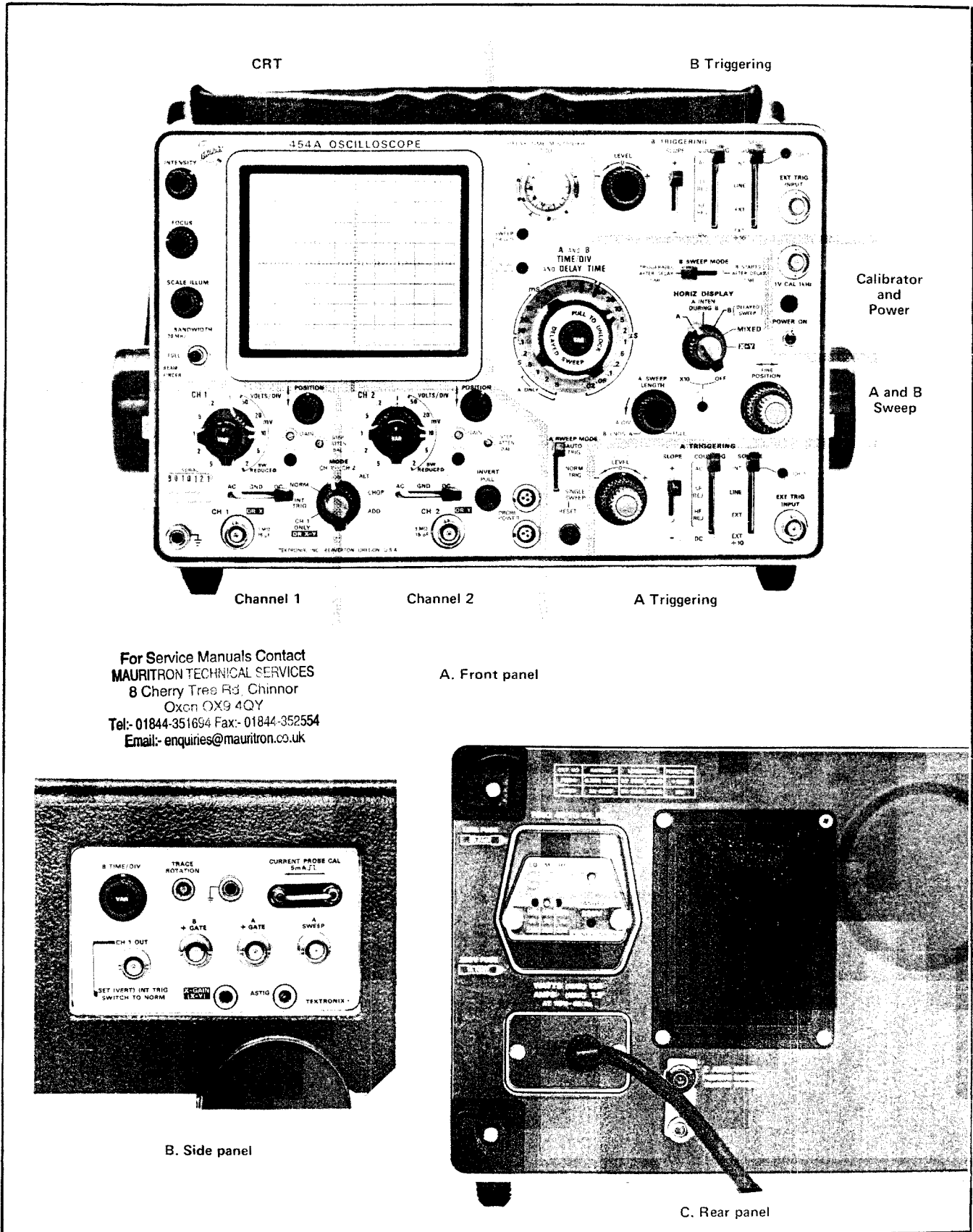

For Service Manuals Contact  
**MAURITRON TECHNICAL SERVICES**  
 8 Chery Tree Rd, Chinnor  
 Oxon OX9 4QY  
 Tel:- 01844-351694 Fax:- 01844-352554  
 Email:- enquiries@mauritron.co.uk

A. Front panel

B. Side panel

C. Rear panel

Fig. 2-4. Front-, side- and rear-panel controls and connectors.

INPUT CH 2 OR Y	Input connector for CH 2 deflection signals or Y-axis deflection in the X-Y mode of operation.	A and B Triggering (both where applicable)	LEVEL	Selects amplitude point on trigger signal at which sweep is triggered.
MODE	Selects vertical mode of operation.		HF STAB (A Triggering Only)	Decreases display jitter for trigger signals above about 40 megahertz. Has negligible effect at lower repetition rates.
	CH 1: The signal connected to the INPUT CH 1 connector is displayed.		SLOPE	Selects slope of trigger signal which starts the sweep.
	CH 2: The signal connected to the INPUT CH 2 connector is displayed.			+: Sweep can be triggered from positive-going portion of trigger signal.
	ALT: Dual-trace display of signals on both channels. Display switched at end of each sweep.			-: Sweep can be triggered from negative-going portion of trigger signal.
	CHOP: Dual-trace display of signals on both channels. Display switched between channels at a repetition rate of about one megahertz.	COUPLING		Determines method of coupling trigger signal to trigger circuit.
	ADD: Signals applied to the INPUT CH 1 and INPUT CH 2 connectors are algebraically added and the algebraic sum is displayed on the CRT. The INVERT switch in Channel 2 allows the display to be CH 1 + CH 2 or CH 1 - CH 2.			AC: Rejects DC and attenuates signals below about 30 hertz. Accepts signals between about 30 hertz and 150 megahertz.
INT TRIGGER	Selects source of internal triggering signal from vertical system. Also selects the source of the X signal for X-Y mode operation.			LF REJ: Rejects DC and attenuates signals below about 50 kilohertz. Accepts signals between about 50 kilohertz and 150 megahertz.
	NORM: Sweep circuits triggered from displayed channel(s). Channel 1 signal available at CH 1 OUT connector.			HF REJ: Accepts signals between about 30 hertz and 50 kilohertz; rejects DC and attenuates signals outside the above range.
	CH 1 ONLY OR X-Y: Sweep circuits triggered only from signal applied to the INPUT CH 1 connector. No signal available at CH 1 OUT connector. CH 1 lights, located beside A and B SOURCE switches, indicate that the TRIGGER switch is in the CH 1 ONLY OR X-Y position. For X-Y mode operation, Channel 1 signal is connected to the Horizontal Amplifier.	SOURCE		DC: Accepts all trigger signals from DC to 150 megahertz or greater.
INVERT (CH 2 only)	Inverts the Channel 2 display when pulled out.			Selects source of trigger signal.
				INT: Internal trigger signal obtained from Vertical Deflection System. When CH 1 light is on, trigger signal is obtained only from the Channel 1 input signal; when the light is off, the trigger signal is obtained from the displayed channel(s). Source of internal trigger signal is selected by the TRIGGER switch.
				LINE: Trigger signal obtained from a sample of the line voltage applied to this instrument.

	EXT: Trigger signal obtained from an external signal applied to the EXT TRIG INPUT connector.	B SWEEP MODE	Selects B sweep operation mode.
	EXT ÷ 10: Attenuates external trigger signals 10 times.		
CH 1	Light indicates that the internal trigger signal is obtained only from the signal connected to the INPUT CH 1 connector (see TRIGGER switch).		TRIGGERABLE AFTER DELAY TIME: B sweep circuit will not produce a sweep until a trigger pulse is received following the delay time selected by the DELAY TIME (A TIME/DIV) switch and the DELAY-TIME MULTIPLIER dial.
EXT TRIG INPUT	Input connector for external trigger signal.		B STARTS AFTER DELAY TIME: B sweep circuit runs immediately following delay time selected by the DELAY TIME switch and DELAY-TIME MULTIPLIER dial.
A and B Sweep		HORIZ DISPLAY	Selects horizontal mode of operation.
DELAY-TIME MULTIPLIER	Provides variable sweep delay between 0.10 and 10.10 times the delay time indicated by the A TIME/DIV switch.		A: Horizontal deflection provided by A sweep. B sweep inoperative.
A SWEEP TRIG'D	Light indicates that A sweep is triggered and will produce a stable display with correct INTENSITY and POSITION control settings.		A INTEN DURING B: Sweep rate determined by A TIME/DIV switch. An intensified portion appears on the display during the B sweep time. This switch position provides a check of the duration and position of B sweep (delayed sweep) with respect to the delaying sweep (A).
UNCAL A OR B	Light indicates that either the A or B VARIABLE control is not in the CAL position.		B (DELAYED SWEEP): Sweep rate determined by B TIME/DIV switch with the delay time determined by the setting of the DELAY TIME (A TIME/DIV) switch and the DELAY-TIME MULTIPLIER dial. Sweep mode determined by B SWEEP MODE switch.
A AND B TIME/DIV AND DELAY TIME	A TIME/DIV switch (clear plastic inner flange) selects the sweep rate of the A sweep circuit for A sweep only operation and selects the basic delay time (to be multiplied by DELAY-TIME MULTIPLIER dial setting) for delayed sweep operation. B TIME/DIV (DELAYED SWEEP) switch selects sweep rate of the B sweep circuit for delayed sweep operation only. VARIABLE controls must be in the CAL position for calibrated sweep rates.		MIXED: First part of the horizontal sweep displayed at a rate set by the A TIME/DIV switch and the latter part of the sweep at a rate set by the B TIME/DIV switch. Relative amounts of the display allocated to each of the two sweep rates is determined by the setting of the DELAY-TIME MULTIPLIER dial.
A VARIABLE	Provides continuously variable A sweep rate between the calibrated settings selected by the A TIME/DIV switch. The A sweep rate is calibrated when control is set fully clockwise to CAL.		X-Y: Permits X-Y operation when the TRIGGER switch is set to CH 1 ONLY OR X-Y. Signal



applied to the INPUT CH 1 OR X connector provides the X-axis deflection and the signal applied to the INPUT CH 2 or Y connector provides the Y-axis deflection.

**MAG**

Increases sweep rate to ten times setting of the A or B TIME/DIV switch by horizontally expanding the center division of the display. Light indicates when magnifier is on (magnifier inoperative in X-Y mode).

**A SWEEP MODE**

Determines the operating mode for A sweep.

**AUTO TRIG:** Sweep initiated by the applied trigger signal at point selected by the LEVEL/SLOPE control when the trigger signal repetition rate is above about 30 hertz and within the frequency range selected by the COUPLING switch. Triggered sweep can be obtained only over the amplitude range of the applied trigger signal. When the LEVEL/SLOPE control is outside the amplitude range, the trigger repetition rate is below the lower frequency limit (or above upper limit for AC HF REJ), or the trigger signal is inadequate, the sweep free runs at the sweep rate selected by the TIME/DIV switch to produce a reference trace.

**NORM TRIG:** Sweep initiated by the applied trigger signal at any point selected by the LEVEL/SLOPE control over the frequency range selected by the COUPLING switch. Triggered sweep can be obtained only over the amplitude range of the applied trigger signal. When the LEVEL/SLOPE control is outside the amplitude range, the trigger repetition rate is outside the frequency range selected by the COUPLING switch, or the trigger signal is inadequate, there is no trace.

**RESET**

**SINGLE SWEEP:** After a sweep is displayed, further sweeps cannot be presented until the RESET button is pressed. Display is triggered as for NORM operation using the A Triggering controls.

When the RESET button is pressed (SINGLE SWEEP mode), a single display will be presented (with correct triggering). After the sweep is completed, the RESET button must be pressed again before another sweep can be displayed.

**A SWEEP LENGTH**

Adjust length of A sweep. In the FULL position (clockwise detent), the sweep is about 11 divisions long. As this control is rotated counterclockwise, the length of A sweep is reduced until it is less than four divisions long just before the detent in the fully-counterclockwise position is reached. In the B ENDS A position (counterclockwise detent), the A sweep is reset at the end of the B sweep to provide the fastest possible sweep repetition rate for delayed sweep signals.

**POSITION**

Controls horizontal position of trace.

**FINE**

Provides more precise horizontal position adjustment.

**1 V CAL 1 kHz**

Calibrator output connector.

**POWER ON**

Light: Indicates that POWER switch is on and the instrument is connected to a line-voltage source.

Switch: Controls power to the instrument.

**Side Panel**

**B TIME/DIV VARIABLE**

Provides continuously variable B sweep rate between the calibrated sweeps selected by the B TIME/DIV switch. B sweep rate is calibrated when control is set fully clockwise to CAL.

## Operating Instructions—454A/R454A

TRACE ROTATION	Screwdriver adjustment to align trace with horizontal graticule lines.
CURRENT PROBE CAL	Current loop providing five-milliampere square-wave current from calibrated circuit.
CH 1 OUT	Output connector providing a sample of the signal applied to the INPUT CH 1 connector when the TRIGGER switch is in the NORM position.
B + GATE	Output connector providing a rectangular pulse coincident with B Sweep.
A + GATE	Output connector providing a rectangular pulse coincident with A Sweep.
A SWEEP	Output connector providing a sample of the sawtooth signal produced by the A Sweep Generator.
X-GAIN (X-Y)	Screwdriver adjustment to calibrate X-axis deflection in the X-Y mode.
ASTIG	Screwdriver adjustment used in conjunction with the FOCUS control to obtain a well defined display. Does not require readjustment in normal use.
<b>Rear Panel</b>	
Z AXIS INPUT	Input connector for intensity modulation of the CRT display.
Line Voltage Selector	Switching assembly to select the nominal operating voltage and the line voltage range. The assembly also includes the line fuses.
	Voltage Selector: Selects nominal operating voltage range (115 V or 230 V).
	Range Selector: Selects line voltage range (low, medium, high).

## FIRST-TIME OPERATION

### General

The following steps will demonstrate the use of the controls and connectors of the 454A. It is recommended that this procedure be followed completely for familiarization with this instrument.

### Setup Information

1. Set the controls as follows:

#### CRT Controls

INTENSITY	Counterclockwise
FOCUS	Midrange
SCALE ILLUM	Counterclockwise
BANDWIDTH-BEAM FINDER	FULL

#### Vertical Controls (both channels if applicable)

VOLTS/DIV	.2
VARIABLE	CAL
POSITION	Midrange
Input Coupling	DC
MODE	CH 1
TRIGGER	NORM
INVERT	Pushed in

#### Triggering Controls (both A and B if applicable) All lever switches up.

LEVEL	Clockwise (+)
SLOPE	+
COUPLING	AC
SOURCE	INT

#### Sweep Controls

DELAY-TIME	0.10 (fully counterclockwise)
MULTIPLIER	
A and B TIME/DIV	.5 ms
A VARIABLE	CAL (fully clockwise)
A SWEEP MODE	AUTO TRIG
B SWEEP MODE	B STARTS AFTER DELAY TIME
HORIZ DISPLAY	A
MAG	OFF
POSITION	Midrange
A SWEEP LENGTH	FULL (fully clockwise)
POWER	OFF

#### Side-Panel Controls

B TIME/DIV VARIABLE	CAL (fully clockwise)
---------------------	-----------------------

2. Connect the 454A to a power source that meets the voltage and frequency requirements of the instrument. If the available line voltage is outside the limits of the Line Voltage Selector switch position (on rear panel), see Operating Voltage in this section.

3. Set the POWER switch to ON. Allow several minutes warmup so the instrument reaches a normal operating temperature before proceeding.

### CRT Controls

4. Advance the INTENSITY control until the trace is at the desired viewing level (near midrange).

5. Connect the 1 V CAL 1 kHz connector to the INPUT CH 1 connector with a BNC cable.

6. Turn the A LEVEL control toward 0 until the display becomes stable. Note that the A SWEEP TRIG'D light is on when the display is stable.

7. Adjust the FOCUS control for a sharp, well-defined display over the entire trace length. (If focused display cannot be obtained, see Astigmatism Adjustment in this section.)

8. Disconnect the input signal and move the trace with the CH 1 POSITION control so it coincides with the center horizontal line of the graticule.

9. If the trace is not parallel with the center horizontal line, see Trace Alignment Adjustment in this section.

10. Rotate the SCALE ILLUM control throughout its range and notice that the graticule lines are illuminated as the control is turned clockwise (most obvious with mesh or smoke-gray filter installed). Set control so graticule lines are illuminated as desired.

### Vertical Controls

11. Change the CH 1 VOLTS/DIV switch from 20 mV to 5 mV. If the vertical position of the trace shifts, see Step Attenuator Balance in this section.

12. Set the CH 1 VOLTS/DIV switch to .2 and the CH 1 Input Coupling switch to AC.

13. Connect the 1 V CAL 1 kHz connector to both the INPUT CH 1 and CH 2 connectors with two BNC cables and a BNC T connector.

### NOTE

*If the BNC cables and BNC T connector are not available, make the following changes in the procedure. Place the BNC jack post (supplied accessory) on the 1 V CAL 1 kHz connector and connect the two 10X probes (supplied accessories) to the INPUT CH 1 and CH 2 connectors. Connect the probe tips to the BNC jack post. Set the CH 1 and CH 2 VOLTS/DIV switches to deflection factors that are 1/10th of those given.*

14. Turn the CH 1 POSITION control to center the display. The display is a square wave, five divisions in amplitude with about five cycles displayed on the screen. If the display is not five divisions in amplitude, see Vertical Gain Adjustment in this section.

15. Set the CH 1 Input Coupling switch to GND and position the trace to the center horizontal line with the Channel 1 POSITION control. This provides a ground reference at the center line.

16. Set the CH 1 Input Coupling switch to DC. Note that the baseline of the waveform remains at the center horizontal line (ground reference).

17. Set the CH 1 Input Coupling switch to AC. Note that the waveform is centered about the center horizontal line.

18. Turn the CH 1 VARIABLE control throughout its range. Note that the UNCAL light comes on when the VARIABLE control is moved from the CAL position (fully clockwise). The deflection should be reduced to about two divisions in the fully counterclockwise position. Return the CH 1 VARIABLE control to CAL.

19. Set the MODE switch to CH 2.

20. Set the CH 2 Input Coupling switch to GND and check the Channel 2 step attenuator balance as described in step 11. Return the CH 2 Input Coupling switch to DC.

21. Turn the CH 2 POSITION control to center the display. The display will be similar to the previous display for Channel 1. Check the Channel 2 gain as described in step 14. The CH 2 Input Coupling switch and VARIABLE control operate as described in steps 15 through 18.

22. Set both VOLTS/DIV switches to .5.

23. Set the MODE switch to ALT and position the Channel 1 waveform to the top of the graticule area and the Channel 2 waveform to the bottom of the graticule area. Turn the A TIME/DIV switch throughout its range. Note that the display alternates between channels at all sweep rates.

24. Set the MODE switch to CHOP and the A TIME/DIV switch to 2  $\mu$ s. Note the switching between channels as shown by the segmented trace. Set the TRIGGER switch to CH 1 ONLY; the trace should appear more solid since it is no longer triggered on the between-channel switching transients. Turn the A TIME/DIV switch throughout its range. A dual-trace display is presented at all sweep rates, but unlike ALT, both channels are displayed on each sweep on a time-sharing basis. Return the A TIME/DIV switch to .5 ms.

25. Set the MODE switch to ADD. The display should be four divisions in amplitude. Note that either POSITION control moves the display.

26. Pull the INVERT switch to invert the Channel 2 signal. The display is a straight line (if the Channel 1 and 2 gain is set correctly) indicating that the algebraic sum of the two signals is zero. Set either VOLTS/DIV switch to .2. The square-wave display indicates that the algebraic sum of the two signals is no longer zero. Return the MODE switch to CH 1 and both VOLTS/DIV switches to .2. Push in the INVERT switch.

### Triggering

27. Rotate the A LEVEL control throughout its range. The display free runs at the extremes of rotation. Note that the A SWEEP TRIG'D light is on only when the display is triggered.

28. Set the A SWEEP MODE switch to NORM TRIG. Again rotate the A LEVEL control throughout its range. A display is presented only when correctly triggered. The A SWEEP TRIG'D light operates as in AUTO TRIG. Return the A SWEEP MODE switch to AUTO TRIG.

29. Set the A SLOPE switch to -. The trace starts on the negative part of the square wave. Return the switch to +; the trace starts with the positive part of the square wave.

30. Set the A COUPLING switch to DC. Turn the CH 1 POSITION control until the display becomes unstable (only part of square wave visible). Return the A COUPLING switch to AC; the display is again stable. Since changing trace position changes DC level, this shows how changes in

the DC level affect DC trigger coupling. Return the display to the center of the screen.

31. Set the MODE switch to CH 2; the display should be stable. Remove the signal connected to Channel 1; the display free runs. Set the TRIGGER switch to NORM; the display is again stable. Note that the CH 1 lights in A and B Triggering go out when the TRIGGER switch is changed to NORM.

32. Set the A SOURCE switch to LINE. Connect a 10X probe (supplied accessory) to the Channel 2 INPUT connector. Connect the probe tip to a line-voltage source and set the CH 2 VOLTS/DIV switch for a display about four divisions in amplitude. If necessary, adjust the A LEVEL control for a stable display of the sine wave. Notice that the display starts on the correct slope. Disconnect the probe.

33. Connect the Calibrator signal to both the INPUT CH 2 connector and the A EXT TRIG INPUT connector. Set the A SOURCE switch to EXT. Operation of the LEVEL, SLOPE and COUPLING controls for external triggering are the same as described in steps 27 through 30.

34. Set the A SOURCE switch to EXT  $\div$  10. Operation is the same as for EXT. Note that the A LEVEL control has less range in this position, indicating trigger signal attenuation. Return the A SOURCE switch to INT.

35. Operation of the B Triggering controls is similar to A Triggering.

### Normal and Magnified Sweep

36. Set the A TIME/DIV switch to 5 ms and the MAG switch to X10. The display should be similar to that obtained with the A TIME/DIV switch set to .5 ms and the MAG switch to OFF.

37. Turn the Horizontal POSITION control throughout its range; the display should be positionable across the complete display area. Now turn the FINE control. The display moves a smaller amount and allows more precise positioning. Return the A TIME/DIV switch to .5 ms, the MAG switch to OFF and return the start of the trace to the left graticule line.

38. Turn the A VARIABLE control throughout its range. Note that the UNCAL A OR B light comes on when the A VARIABLE control is moved from the CAL position (fully clockwise). The sweep rate is slower by about 2.5

times in the fully counterclockwise position as indicated by more cycles displayed on the CRT. Return the A VARIABLE control to CAL.

### Delayed Sweep

39. Pull the DELAYED SWEEP knob out and turn it to  $50 \mu\text{s}$  (DELAY TIME remains at .5 ms). Set the HORIZ DISPLAY switch to A INTEN DURING B. An intensified portion, about one division in length, should be shown at the start of the trace. Rotate the DELAY-TIME MULTIPLIER dial throughout its range; the intensified portion should move along the display.

40. Set the B SWEEP MODE switch to TRIGGERABLE AFTER DELAY TIME and set the B LEVEL control to midrange. Again rotate the DELAY-TIME MULTIPLIER dial throughout its range and note that the intensified portion appears to jump between positive slopes of the display. Set the B SLOPE switch to  $-$ ; the intensified portion begins on the negative slope. Rotate the B LEVEL control; the intensified portion of the display disappears when the B LEVEL control is out of the triggerable range. Return the B LEVEL control to 0.

41. Set the HORIZ DISPLAY switch to B (DELAYED SWEEP). Rotate the DELAY-TIME MULTIPLIER dial throughout its range; about one-half cycle of the waveform should be displayed on the screen (leading edge visible only at high INTENSITY control setting). The display remains stable on the screen, indicating that the B sweep is triggered.

42. Turn the B VARIABLE control throughout its range. Note that the UNCAL A OR B light comes on when the B VARIABLE control is moved from the CAL position (fully clockwise). The sweep rate is slower by about 2.5 times in the fully counterclockwise position as indicated by more cycles displayed on the CRT. Return the B VARIABLE control to CAL.

43. Set the B SWEEP MODE switch to B STARTS AFTER DELAY TIME. Rotate the DELAY-TIME MULTIPLIER dial throughout its range; the display moves continuously across the screen as the control is rotated.

44. Rotate the DELAY-TIME MULTIPLIER dial fully counterclockwise and set the HORIZ DISPLAY switch to A INTEN DURING B. Rotate the A SWEEP LENGTH control counterclockwise; the length of the display decreases. Set the control to the B ENDS A position; now the display ends after the intensified portion. Rotate the DELAY-TIME MULTIPLIER dial and note that the sweep length increases as the display moves across the screen.

Return the A SWEEP LENGTH control to FULL and the HORIZ DISPLAY switch to A.

### Single Sweep

45. Set the A SWEEP MODE switch to SINGLE SWEEP. Remove the Calibrator signal from the INPUT CH 2 connector. Press the RESET button; the RESET light should come on and remain on. Again apply the signal to the INPUT CH 2 connector; a single trace should be presented and the RESET light should go out. Return the A SWEEP MODE switch to AUTO TRIG.

### Mixed Sweep

46. Set the HORIZ DISPLAY switch to MIXED, the A TIME/DIV to 1 ms, the B TIME/DIV to .1 ms, and the DELAY-TIME MULTIPLIER to 5.00. Set the B SWEEP MODE switch to B STARTS AFTER DELAY TIME. Approximately the first half of the CRT display will be at the sweep rate set by the A TIME/DIV switch and the last half will be at the rate set by the B TIME/DIV switch. Rotate the DELAY-TIME MULTIPLIER control and note the varying portions of the CRT display allocated to each sweep rate.

### X-Y

47. Connect the Calibrator signal to the INPUT CH 1 and CH 2 connectors with two BNC cables and a BNC T connector. Set the HORIZ DISPLAY switch to X-Y and the TRIGGER switch to CH 1 ONLY OR X-Y.

48. Increase the INTENSITY control setting until two dots are displayed diagonally. The display can be positioned horizontally with the CH 1 POSITION control and vertically with the CH 2 POSITION control. The dots should be five divisions apart vertically and horizontally (if horizontal deflection is incorrect, see X-Y Operation in this section).

49. Change the CH 1 VOLTS/DIV switch to .5. The display is reduced to two divisions horizontally. Now set the CH 2 VOLTS/DIV switch to .5. The display is reduced to two divisions vertically.

### Beam Finder

50. Set the CH 1 and CH 2 VOLTS/DIV switches to 10 mV. The display is not visible, since it exceeds the scan area of the CRT.

51. Press the BANDWIDTH-BEAM FINDER switch down. Note that the display is returned to the display area. While holding the BANDWIDTH-BEAM FINDER switch

## Operating Instructions—454A/R454A

down, increase the vertical and horizontal deflection factors until the display is reduced to about three divisions vertically and horizontally. Adjust the CH 1 and CH 2 POSITION controls to center the display about the center lines of the graticule. Release the BANDWIDTH-BEAM FINDER switch and note that the display remains within the viewing area. Disconnect the applied signal.

52. Reduce the INTENSITY control setting to normal, set the TRIGGER switch to NORM and set the HORIZ DISPLAY switch to A.

### Bandwidth Limiter

53. Set the CH 2 VOLTS/DIV switch to 5 mV. Connect an unshielded lead about four feet long to the INPUT CH 2 connector. Set the A TIME/DIV switch to  $.1 \mu\text{s}$  and note the high-frequency noise in the display (this demonstration is most effective in localities with strong radiated interference above five megahertz, such as TV broadcasting radiation; if little interference is present, a 50 megahertz sine-wave signal applied to the INPUT CH 2 connector will produce a similar result).

54. Set the BANDWIDTH-BEAM FINDER switch to 20 MHz (up). Note that the high-frequency noise is eliminated from the display. Return the BANDWIDTH-BEAM switch to FULL.

### Z-Axis Input

55. If an external signal is available (five volts peak-to-peak minimum), the function of the Z AXIS INPUT circuit can be demonstrated. Remove the ground strap from the Z AXIS INPUT binding posts. Connect the external signal to both the INPUT CH 2 connector and the Z AXIS INPUT binding post. Set the TIME/DIV switch to display about five cycles of the waveform. The positive peaks of the waveform should be blanked and the negative peaks intensified, indicating intensity modulation. Remove the input signal from the Z AXIS INPUT and replace the ground strap.

56. This completes the basic operating procedure for the 454A. Instrument operations not explained here, or operations which need further explanation are discussed under General Operating Information.

## GENERAL OPERATING INFORMATION

### Simplified Operating Instructions

**General.** The following operating instructions will allow calibrated measurements in most applications. The operator should be familiar with the complete function and

operation of the instrument as described in this section before using this procedure.

### Normal Sweep Display

1. Set INTENSITY control fully counterclockwise.
2. Set Input Coupling switches to AC, VARIABLE VOLTS/DIV controls to CAL and vertical MODE switch to CH 1 (use ALT or CHOP for dual-trace display).
3. Push A SWEEP MODE, A SLOPE, A COUPLING, and A SOURCE switches to up position.
4. Set the A TIME/DIV switch to 1 ms/DIV, VARIABLE TIME/DIV controls to CAL and HORIZ DISPLAY switch to A.
5. Set POWER switch to ON. Allow several minutes warmup.
6. Connect signal to vertical INPUT connector.
7. Advance INTENSITY control until display is visible (if display is not visible with INTENSITY control at midrange, press BANDWIDTH-BEAM FINDER switch down and adjust VOLTS/DIV switch until display is reduced in size vertically; then center compressed display with vertical and horizontal POSITION controls; release BANDWIDTH-BEAM FINDER switch). Set FOCUS control for well-defined display.
8. Set VOLTS/DIV switch and vertical POSITION control for display which remains on display area vertically.
9. Set A LEVEL control for stable display.
10. Set A TIME/DIV switch and horizontal POSITION control for display which remains on the display area horizontally.

### Magnified Sweep Display

1. Follow steps 1 – 10 for normal sweep.
2. Adjust horizontal POSITION control to move area to be magnified within center division of CRT. If necessary, change TIME/DIV switch setting so complete area to be magnified is within center division.

3. Set MAG switch to X10 and adjust horizontal FINE control for precise positioning of magnified display.

### Delayed Sweep Display

1. Follow steps 1 – 10 for normal sweep.
2. Set B SWEEP MODE switch to B STARTS AFTER DELAY TIME, HORIZ DISPLAY switch to A INTEN DURING B, and A SWEEP LENGTH control to FULL.
3. Pull out DELAYED SWEEP (B TIME/DIV) switch and turn clockwise so intensified zone on display is desired length (intensified zone will be displayed in delay form). If intensified zone is not visible, change INTENSITY control setting.
4. Adjust DELAY-TIME MULTIPLIER dial to position intensified zone to portion of display to be delayed.
5. Set HORIZ DISPLAY switch to B (DELAYED SWEEP). Delayed sweep rate is shown by dot on DELAYED SWEEP Switch.
6. For delayed sweep display with less jitter, set B SWEEP MODE switch to TRIGGERABLE AFTER DELAY TIME, all B Triggering switches up, and adjust B LEVEL control for stable display.

### X-Y Display

1. Set INTENSITY control fully counterclockwise.
2. Set Input Coupling switches to AC and VARIABLE VOLTS/DIV controls to CAL.
3. Set TRIGGER switch to CH 1 ONLY OR X-Y and HORIZ DISPLAY switch to X-Y.
4. Set POWER switch to ON. Allow several minutes warmup.
5. Connect X (horizontal) signal to INPUT CH 1 OR X connector and Y (vertical) signal to INPUT CH 2 OR Y connector.
6. Advance INTENSITY control until display is visible (if display is not visible, press BANDWIDTH-BEAM FINDER switch down and adjust CH 1 and CH 2

VOLTS/DIV switches until display is reduced in size both vertically and horizontally; then center compressed display with CH 1 and CH 2 POSITION controls; release BANDWIDTH-BEAM FINDER switch). Set FOCUS control for well-defined display.

7. Set CH 1 and CH 2 VOLTS/DIV switches and POSITION controls for display which remains on display area. CH 1 controls affect horizontal deflection, and CH 2 controls affect vertical deflection.

### Intensity Control

The setting of the INTENSITY control may affect the correct focus of the display. Slight readjustment of the FOCUS and ASTIGMATISM controls may be necessary when the intensity level is changed. To protect the CRT phosphor, do not turn the INTENSITY control higher than necessary to provide a satisfactory display. The light filters reduce the observed light output from the CRT. When using these filters, avoid advancing the INTENSITY control to a setting that may burn the phosphor. When the highest intensity display is desired, remove the filters and use the clear graticule only. Apparent trace intensity can also be improved in such cases by reducing the ambient light or using a viewing hood. Also be careful that the INTENSITY control is not set too high when changing the TIME/DIV switch from a fast to a slow sweep rate, or when switching to the external horizontal mode of operation.

### Astigmatism Adjustment

If a well-defined display cannot be obtained with the FOCUS control, adjust the ASTIG adjustment (side panel) as follows.

#### NOTE

*To check for proper setting of the ASTIG adjustment, slowly turn the FOCUS control through the optimum setting. If the ASTIG adjustment is correctly set, the vertical and horizontal portions of the display will come into sharpest focus at the same position of the FOCUS control. The setting of the ASTIG adjustment should be correct for any display. However, it may be necessary to reset the FOCUS control slightly when the INTENSITY control is changed.*

1. Connect the 1 V CAL 1 kHz connector to either channel and set the VOLTS/DIV switch of that channel to present a two-division display. Set the MODE switch to display the channel selected.
2. Set the TIME/DIV switch to .2 ms.

## Operating Instructions—454A/R454A

3. With the FOCUS control and ASTIG adjustment set to midrange, adjust the INTENSITY control so the rising portion of the display can be seen.

4. Set the ASTIG adjustment so the horizontal and vertical portions of the display are equally focused, but not necessarily well focused.

5. Set the FOCUS control so the vertical portion of the trace is as thin as possible.

6. Repeat parts 4 and 5 for the best overall focus. Make the final check for normal intensity.

### Trace Alignment Adjustment

If a free-running trace is not parallel to the horizontal graticule lines, set the TRACE ROTATION adjustment (side-panel) as follows. Position the trace to the center horizontal line. Adjust the TRACE ROTATION adjustment so the trace is parallel with the horizontal graticule lines.

### Graticule

The graticule of the 454A is internally marked on the faceplate of the CRT to provide accurate, no-parallax measurements. The graticule is marked with eight vertical and 10 horizontal divisions. Each division is 0.8 centimeter square. In addition, each major division is divided into five minor divisions at the center vertical and horizontal lines. The vertical gain and horizontal timing are calibrated to the graticule so accurate measurements can be made from the CRT. The illumination of the graticule lines can be varied with the SCALE ILLUM control.

Fig. 2-5 shows the graticule of the 454A and defines the various measurement lines. The terminology defined here will be used in all discussions involving graticule measurements.

### Light Filter

The tinted light filter minimizes light reflection from the face of the CRT to improve contrast when viewing the display under high ambient light conditions. A clear plastic faceplate protector is also provided with this instrument for use when the tinted filter is not used. The clear faceplate protector provides the best display for waveform photographs. It is also preferable for viewing high writing rate displays. To remove the filter, press down at the bottom of the frame and pull the top of the filter away from the CRT faceplate (see Fig. 2-6).

A filter or the faceplate protector should be used at all times to protect the CRT faceplate from scratches. The

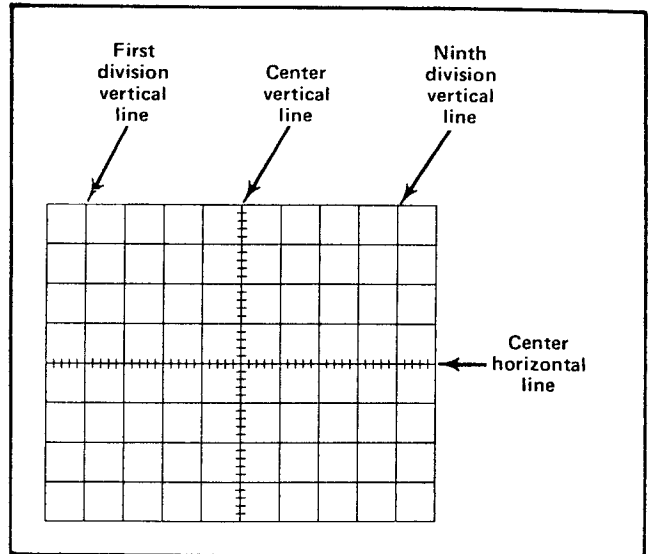

Fig. 2-5. Definition of measurement lines on 454A graticule.

faceplate protector and the tinted light filter mount in the same holder. To remove the light filter or faceplate protector from the holder, press it out to the rear. They can be replaced by snapping them back into the holder.

### Beam Finder

The BANDWIDTH-BEAM FINDER switch provides a means of locating a display which overscans the viewing area either vertically or horizontally. When the

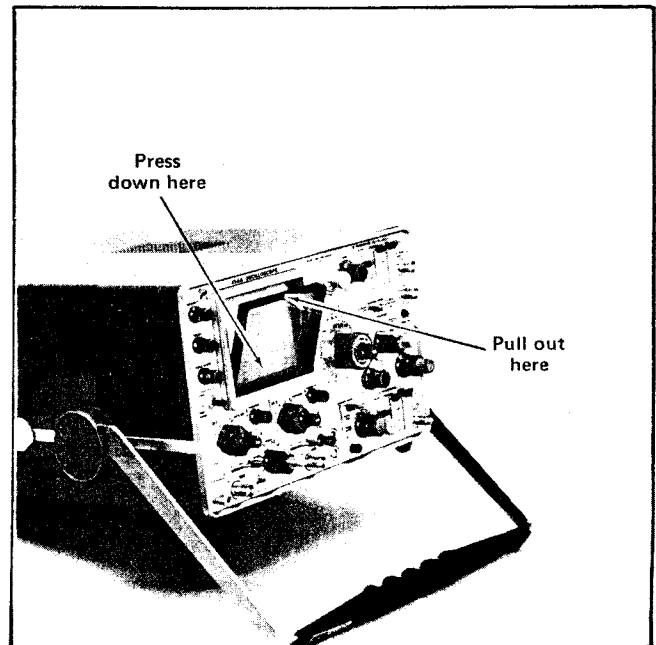

Fig. 2-6. Removing the filter or faceplate protector.



BANDWIDTH-BEAM FINDER switch is pressed down, the display is compressed within the graticule area. To locate and reposition an overscanned display, use the following procedure:

1. Press the BANDWIDTH-BEAM FINDER switch down.
2. While the BANDWIDTH-BEAM FINDER switch is held down, increase the vertical and horizontal deflection factors until the vertical deflection is reduced to about three divisions and the horizontal deflection is reduced to about four divisions (the horizontal deflection needs to be reduced only when in the X-Y mode of operation).
3. Adjust the vertical and horizontal position controls to center the display about the vertical and horizontal center lines.
4. Release the BANDWIDTH-BEAM FINDER switch; the display should remain within the viewing area.

**Bandwidth Limiter**

The BANDWIDTH-BEAM FINDER switch provides a method of reducing interference from unwanted high-frequency signals when viewing low-frequency signals. In the FULL position, the full bandwidth capabilities of the Vertical Deflection system are available. When set to the 20 MHz position (up), the upper -3 dB bandwidth point of the Vertical Deflection system is limited to about 20 megahertz. Then unwanted high-frequency signals (such as television broadcast radiation interference) are reduced in the displayed waveform. Fig. 2-7 illustrates the use of this feature. The waveform in Fig. 2-7A is the display produced when a low-level, low-frequency signal is viewed in the presence of strong 50-megahertz radiation (BANDWIDTH-BEAM FINDER switch in FULL position). Fig. 2-7B shows the resultant CRT display when the high-frequency interference is reduced by setting the BANDWIDTH-BEAM FINDER switch to the 20 MHz position.

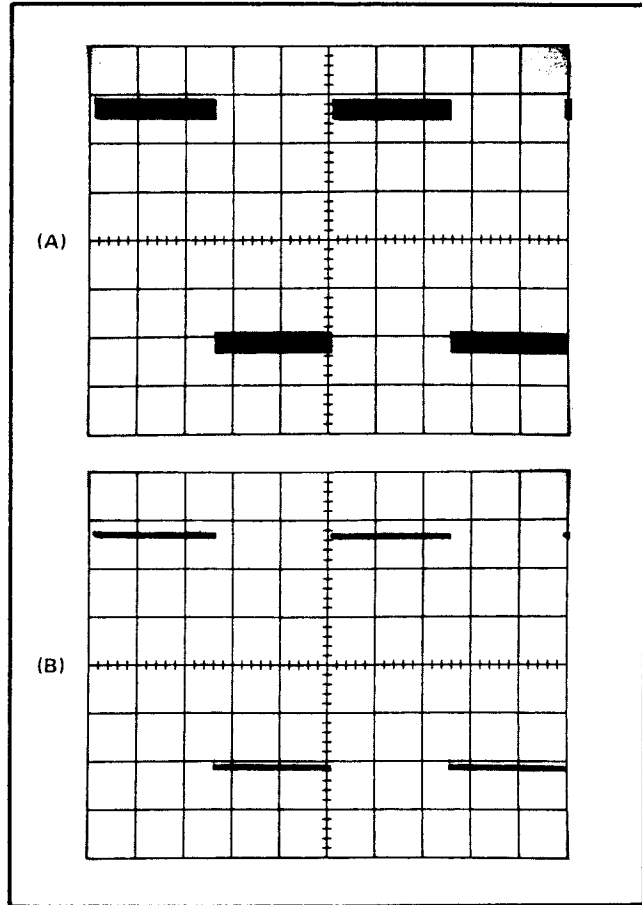

Fig. 2-7. (A) CRT display showing high-frequency interference when attempting to view low-level, low-frequency signal, (B) resultant display when BANDWIDTH-BEAM FINDER switch is set to 20 MHz position.

the INPUT connector of the channel used. The vertical deflection should be exactly five divisions. If not, adjust the front-panel GAIN adjustment for exactly five divisions of deflection.

**NOTE**

*If the gain of the two channels must be closely matched (such as for ADD mode operation), the adjustment procedure given in the Calibration section should be used.*

The best measurement accuracy when using probes is provided if the GAIN adjustment is made with the probes installed (set the VOLTS/DIV switch to 20 mV). This compensates for any inaccuracies of the probes. Also, to provide the most accurate measurements, calibrate the vertical gain of the 454A at the temperatures at which the measurement is to be made.

**Vertical Channel Selection**

Either of the input channels can be used for single-trace displays. Apply the signal to the desired INPUT connector and set the MODE switch to display the channel used. However, since CH 1 ONLY triggering is provided only in Channel 1 and the INVERT feature is provided only in Channel 2, the correct channel must be selected to take advantage of these features. For dual-trace displays, connect the signals to both INPUT connectors and set the MODE switch to one of the dual-trace positions.

**Vertical Gain Adjustment**

To check the gain of either channel, set the VOLTS/DIV switch to .2 and connect the 1 V CAL 1 kHz connector to

### Step Attenuator Balance

To check the step attenuator balance of either channel, set the Input Coupling switch to GND and set the A SWEEP MODE switch to AUTO TRIG to provide a free-running trace. Change the VOLTS/DIV switch from 10 mV to 2 mV. If the trace moves vertically, adjust the front-panel STEP ATTEN BAL adjustment as follows (allow at least 10 minutes warmup before performing this adjustment).

1. With the Input Coupling switch set to GND and the VOLTS/DIV switch set to 10 mV, move the trace to the center horizontal line of the graticule with the vertical POSITION control.

2. Set the VOLTS/DIV switch to 2 mV and adjust the STEP ATTEN BAL adjustment to return the trace to the center horizontal line.

3. Recheck step attenuator balance and repeat adjustment until no trace shift occurs as the VOLTS/DIV switch is changed from 10 mV to 2 mV.

### Signal Connections

In general, probes offer the most convenient means of connecting a signal to the input of the 454A. The Tektronix probes are shielded to prevent pickup of electrostatic interference. A 10X attenuator probe offers a high input impedance and allows the circuit under test to perform very close to normal operating conditions. However, a 10X probe also attenuates the input signal 10 times. The Tektronix P6045 Field Effect Transistor probe offers the same high-input impedance as the 10X probes. However, it is particularly useful since it provides wide-band operation while presenting no attenuation (1X gain) and a low input capacitance. To obtain maximum bandwidth when using the probes, observe the grounding considerations given in the probe manuals. The probe-to-connector adapters and the bayonet-ground tip provides the best frequency response. Remember that a ground strap only a few inches in length can produce several percent of ringing when operating at the higher frequency limit of this system (see Fig. 2-8). Fig. 2-9 graphically illustrates the usable frequency range (at upper -3 dB point) of various Tektronix probes when used with the 454A (for deflection factors from 10 mV to 5 V). Only a few of the available probes are shown in this chart. See your Tektronix, Inc. catalog for characteristics and compatibility of other probes for this system.

In high-frequency applications requiring maximum overall bandwidth, use coaxial cables terminated at both ends in their characteristic impedance. To maintain the high-frequency characteristics of the applied signal, use

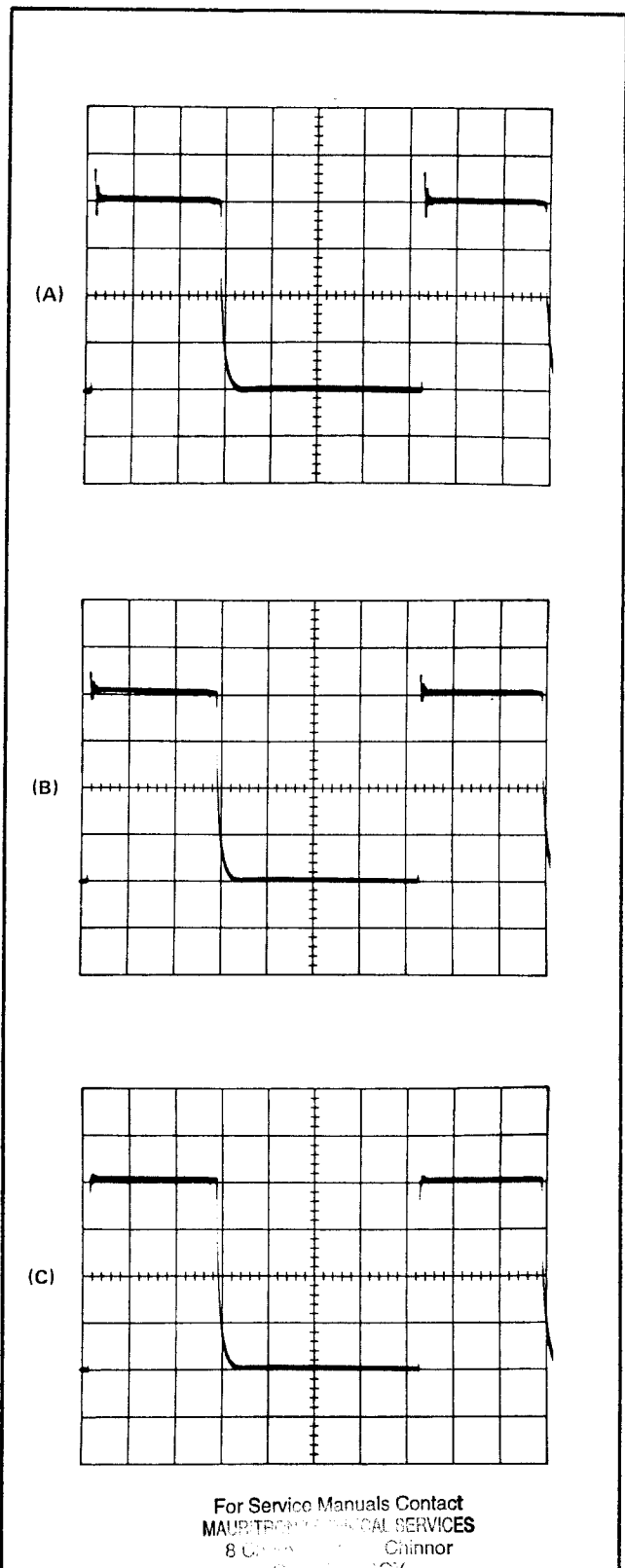

Fig. 2-8. Waveform distortion produced with incorrect probe ground. (A) Five-inch ground lead, (B) three-inch ground lead, (C) bayonet ground adapter.

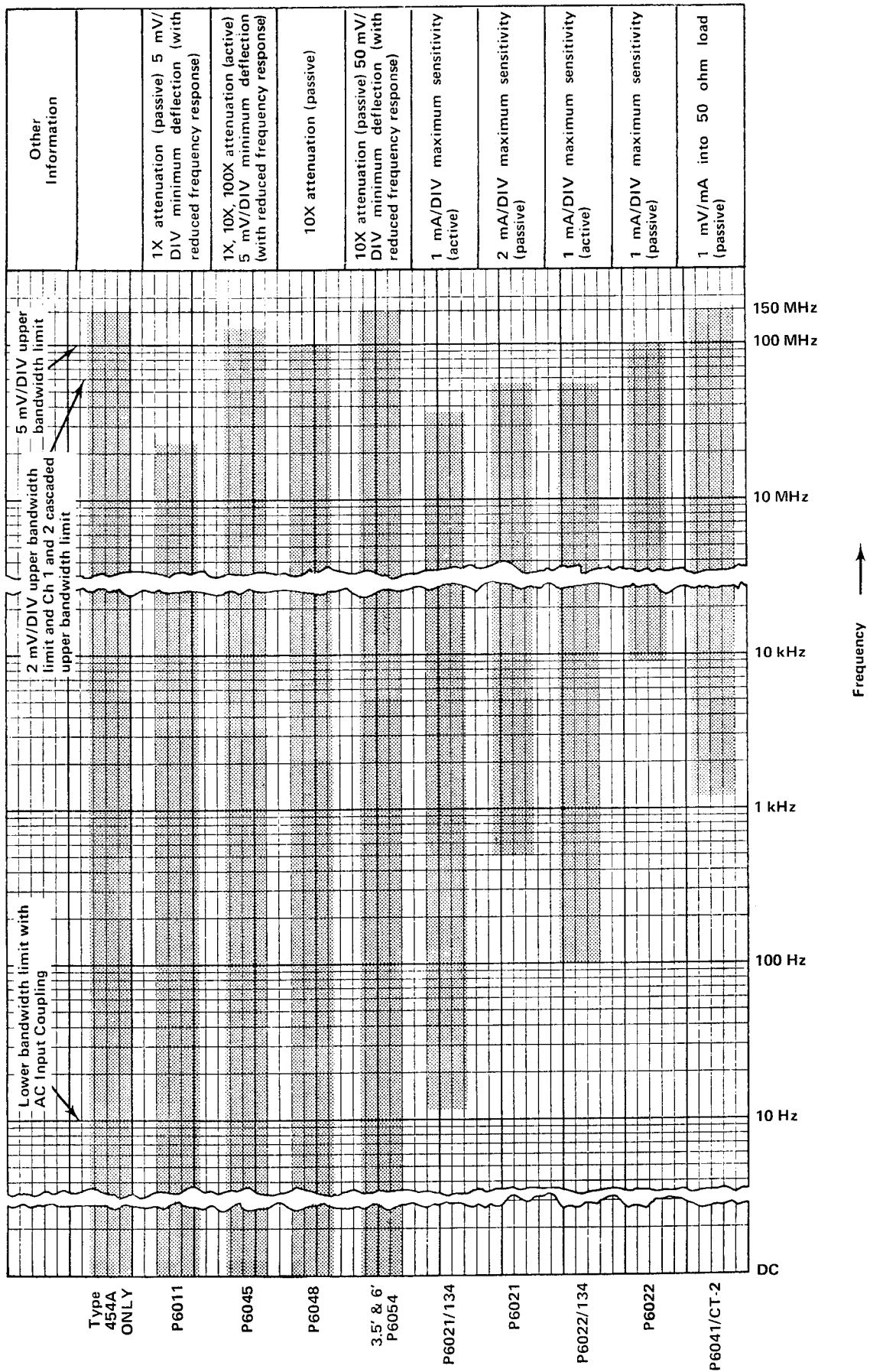

Fig. 2-9. Frequency range of probe coupling (approximate -3 dB points) when driven by 25-ohm source.

## Operating Instructions—454A/R454A

high-quality, low-loss cable. Resistive coaxial attenuators can be used to minimize reflections due to the 15 pF input capacitance if the applied signal has sufficient amplitude.

High-level, low-frequency signals can be connected directly to the 454A INPUT connectors with short unshielded leads. This coupling method works best for signals below about one kilohertz and deflection factors above one volt/division. When this method is used, establish a common ground between the 454A and the equipment under test (common ground provided by line cords is usually inadequate). Attempt to position the leads away from any source of interference to avoid errors in the display. If interference is excessive with unshielded leads, use a coaxial cable or a probe.

### Loading Effect of the 454A

As nearly as possible, simulate actual operating conditions in the equipment under test. Otherwise, the equipment under test may not produce a normal signal. The 10X attenuator and field effect transistor probes mentioned previously offer the least circuit loading. See the probe instruction manual for loading characteristics of the probes.

When the signal is coupled directly to the input of the 454A, the input impedance is about one megohm paralleled by about 15 pF. When the signal is coupled to the input through a coaxial cable, the effective input capacitance depends upon the type and length of cable used and the frequency of the signal.

### Ground Considerations

Reliable signal measurements cannot be made unless both the oscilloscope and the unit under test are connected together by a common reference (ground) lead in addition to the signal lead or probe. Although the three-wire AC power cord provides a common connection when used with equipment with similar power cords, the ground loop produced may make accurate measurements impossible. The ground straps supplied with the probes provide an adequate ground. The shield of a coaxial cable provides a common ground when connected between two coaxial connectors (or with suitable adapters to provide a common ground). When using unshielded signal leads, a common ground lead should be connected from the 454A chassis to the chassis of the equipment under test.

### Input Coupling

The Channel 1 and 2 Input Coupling switches allow a choice of input coupling methods. The type of display desired and the applied signal will determine the coupling to use.

The DC Coupling position can be used for most applications. This position allows measurement of the DC component of a signal. It must also be used to display signals below about 10 hertz (1 hertz with a 10X probe) as they will be attenuated in the AC position.

In the AC Coupling position, the DC component of the signal is blocked by a capacitor in the input circuit. The low-frequency response in the AC position is about 10 hertz (–3 dB point). Therefore, some low-frequency attenuation can be expected near this frequency limit. Attenuation in the form of waveform tilt will also appear in square waves which have low-frequency components. The AC coupling position provides the best display of signals with a DC component which is much larger than the AC components.

The GND position provides a ground reference at the input of the 454A without the need to externally ground the INPUT connectors. The signal applied to the input connector is internally disconnected, but not grounded, and the input circuit is held at ground potential.

The GND position can also be used to pre-charge the coupling capacitor to the average voltage level of the signal applied to the INPUT connector. This allows measurement of only the AC component of signals having both AC and DC components. The pre-charging network incorporated in this unit allows the input-coupling capacitor to charge to the DC source voltage level when the Input Coupling switch is set to GND. The procedure for using this feature is as follows:

1. Before connecting the signal containing a DC component to the 454A INPUT connector, set the Input Coupling switch to GND. Then connect the signal to the INPUT connector.

2. Wait about one second for the coupling capacitor to charge.

3. Set the Input Coupling switch to AC. The trace (display) will remain on the screen and the AC component of the signal can be measured in the normal manner.

### Deflection Factor

The amount of vertical deflection produced by a signal is determined by the signal amplitude, the attenuation factor of the probe (if used), the setting of the VOLTS/DIV switch and the setting of the VARIABLE VOLTS/DIV control. The calibrated deflection factors indicated by the VOLTS/DIV switches apply only when the VARIABLE control is set to the CAL position.

The VARIABLE VOLTS/DIV control provides variable (uncalibrated) vertical deflection between the calibrated settings of the VOLTS/DIV switch. The VARIABLE control extends the maximum vertical deflection factor of the 454A to at least 12.5 volts/division (5 volts position).

### Probe Power Connectors

The two PROBE POWER connectors on the front panel of this instrument provide operating power for active probe systems such as the Tektronix P6045 Field Effect Transistor Probe. It is not recommended that this connector be used as a power source for applications other than the compatible probes. However, if used for other applications, limit the maximum current from both connectors to 50 milliamperes from the +12-volt terminal and 100 milliamperes from the -12-volt terminal. Maintain a constant load on the supplies to avoid adding transients to the system.

### Dual-Trace Operation

**Alternate Mode.** The ALT position of the MODE switch produces a display which alternates between Channel 1 and 2 with each sweep of the CRT. Although the ALT mode can be used at all sweep rates the CHOP mode provides a more satisfactory display at sweep rates below about 20 microseconds/division. At these slower sweep rates, alternate mode switching becomes visually perceptible.

Proper internal triggering in the ALT mode can be obtained in either the NORM or CH 1 ONLY positions of the TRIGGER switch. When in the NORM position, the sweep is triggered from the signal on each channel. This provides a stable display of two unrelated signals, but does not indicate the time relationship between the signals. In the CH 1 ONLY position, the two signals are displayed showing true time relationship. If the signals are not time related, the Channel 2 waveform will be unstable in the CH 1 ONLY position.

**Chopped Mode.** The CHOP position of the MODE switch produces a display which is electronically switched between channels. In general, the CHOP mode provides the best display at sweep rates slower than about 20 microseconds/division or whenever dual-trace, single-shot phenomena are to be displayed. At faster sweep rates the chopped switching becomes apparent and may interfere with the display.

Proper internal triggering for the CHOP mode is provided only when the TRIGGER switch is set to CH 1 ONLY. If the NORM position is used, the sweep circuits are triggered from the between-channel switching signal and both waveforms will be unstable. External triggering from a signal which is time-related to either signal provides the same result as CH 1 ONLY triggering.

Two signals which are time-related can be displayed in the chopped mode showing true time relationship. However, if the signals are not time-related, the Channel 2 display will appear unstable.

Two single-shot, transient, or random signals which occur within the time interval determined by the TIME/DIV switch (10 times sweep rate) can be compared using the CHOP mode. To trigger the sweep correctly, the Channel 1 signal must precede the Channel 2 signal. Since the signals show true time relationship, time difference measurements can be made.

### Channel 1 Output and Cascaded Operation

If a lower deflection factor than provided by the VOLTS/DIV switches is desired, Channel 1 can be used as a wideband preamplifier for Channel 2. Apply the input signal to the INPUT CH 1 connector. Connect a 50-ohm BNC cable (18-inch cable for maximum cascaded frequency response) between the CH 1 OUT connector on the side panel and the INPUT CH 2 connector. Set the MODE switch to CH 2 and the TRIGGER switch to NORM. With both VOLTS/DIV switches set to 2 mV, the deflection factor is less than 400  $\mu$ V/division.

To provide calibrated 400  $\mu$ V/division deflection factor, connect the Calibrator signal to the INPUT CH 1 connector. Set the CH 1 VOLTS/DIV switch to 1 and the CH 2 VOLTS/DIV switch to 2 mV. Adjust the CH 2 VARIABLE control to produce a display exactly five divisions in amplitude. The cascaded deflection factor is determined by dividing the CH 1 VOLTS/DIV switch setting by 5 (CH 2 VOLTS/DIV switch and CH 2 VARIABLE control remain as set above). For example, with the CH 1 VOLTS/DIV switch set to 2 mV, the calibrated deflection factor will be 400  $\mu$ V/division; CH 1 VOLTS/DIV switch set to 5 mV, 1 millivolt/division, etc.

The following operating considerations and basic applications may suggest other uses for this feature.

1. If AC coupling is desired, set the Channel 1 Input Coupling switch to AC and leave the Channel 2 Input Coupling switch set to DC. When both Input Coupling switches are set to DC, DC signal coupling is provided.

2. Keep the CH 1 and CH 2 POSITION control set near midrange. If the input signal has a DC level which necessitates one of the POSITION controls being turned away from midrange, correct operation can be obtained by keeping the CH 2 POSITION control near midrange and using the CH 1 POSITION control to position the trace near the desired location. Then, use the CH 2 POSITION

## Operating Instructions—454A/R454A

control for exact positioning. This method will keep both Input Preamps operating within their linear range.

3. The output voltage at the CH 1 OUT connector is at least 10 millivolts/division of CRT display in all CH 1 VOLTS/DIV switch positions.

4. The MODE switch and CH 1 VARIABLE control have no effect on the signal available at the CH 1 OUT connector.

5. The Channel 1 Input Preamp can be used as an impedance matching stage with or without voltage gain. The input resistance is one megohm and the output resistance is about 50 ohms.

6. The output level at the CH 1 OUT connector is about 0 volts DC for a 0 volt DC input level (CH 1 POSITION control centered). The CH 1 POSITION control can be used to center the output signal within the dynamic range of the amplifier.

7. If dual-trace operation is used, the signal applied to the INPUT CH 1 connector is displayed when Channel 1 is turned on. When Channel 2 is turned on, the amplifier signal is displayed. Thus, the input signal can be monitored by Channel 1 while the amplifier signal is displayed by Channel 2.

8. In special applications where the flat frequency response of the 454A is not desired, a filter inserted between the CH 1 OUT and INPUT CH 2 connectors allows the oscilloscope to essentially take on the frequency response of the filter. Combined with method 7, the input can be monitored by Channel 1 and the filtered signal displayed by Channel 2.

9. By using Channel 1 as a 5X low-level voltage preamplifier (2 mV position), the signal available at the CH 1 OUT connector can be used for any application where a low-impedance preamplifier signal is needed. Remember that if a 50-ohm load impedance is used, the output signal amplitude is about one-half.

### Algebraic Addition

**General.** The ADD position of the MODE switch can be used to display the sum or difference of two signals, for common-mode rejection to remove an undesired signal, or for DC offset (applying a DC voltage to one channel to offset the DC component of a signal on the other channel).

The common-mode rejection ratio of the 454A is greater than 10:1 at 50 megahertz for signal amplitudes up to eight times the VOLTS/DIV switch setting. Rejection ratios of 100:1 can typically be achieved between DC and five megahertz by careful adjustment of the gain of either channel while observing the displayed common-mode signal.

**Deflection Factor.** The overall deflection in the ADD position of the MODE switch when both VOLTS/DIV switches are set to the same position is the same as the deflection factor indicated by either VOLTS/DIV switch. The amplitude of an added mode display can be determined directly from the resultant CRT deflection multiplied by the deflection factor indicated by either VOLTS/DIV switch. However, if the CH 1 and CH 2 VOLTS/DIV switches are set to different deflection factors, the resultant voltage is difficult to determine from the CRT display. In this case, the voltage amplitude of the resultant display can be determined accurately only if the amplitude of the signal applied to either channel is known.

**Precautions.** The following general precautions should be observed when using the ADD mode.

1. Do not exceed the input voltage rating of the 454A.
2. Do not apply signals that exceed an equivalent of about eight times the VOLTS/DIV switch setting. For example, with a VOLTS/DIV switch setting of .5, the voltage applied to that channel should not exceed about four volts. Larger voltages may distort the display.
3. Use CH 1 and CH 2 POSITION control settings which most nearly position the signal of each channel to midscreen when viewed in either the CH 1 or CH 2 positions of the MODE switch. This insures the greatest dynamic range for ADD mode operation.
4. For similar response from each channel, set the CH 1 and CH 2 Input Coupling switches to the same position.

### Trigger Source

**INT.** For most applications, the sweep can be triggered internally. In the INT position of the Triggering SOURCE switch, the trigger signal is obtained from the Vertical Deflection System. The TRIGGER switch provides further selection of the internal trigger signal; obtained from the Channel 1 signal in the CH 1 ONLY position, or from the displayed signal when in the NORM position. For single-trace displays of either channel, the NORM position provides the most convenient operation. However, for

dual-trace displays, special considerations must be made to provide the correct display. See Dual-Trace Operation in this section for dual-trace triggering information.

**LINE.** The LINE position of the SOURCE switch connects a sample of the power-line voltage to the Trigger Generator. Line triggering is useful when the input signal is time-related (multiple or sub-multiple) to the line frequency. It is also useful for providing a stable display of a line-frequency component in a complex waveform.

**EXT.** An external signal connected to the EXT TRIG INPUT connector can be used to trigger the sweep in the EXT position of the SOURCE switch. The external signal must be time-related to the displayed signal for a stable display. An external trigger signal can be used to provide a triggered display when the internal signal is too low in amplitude for correct triggering, or contains signal components on which it is not desired to trigger. It is also useful when signal tracing in amplifiers, phase-shift networks, wave-shaping circuits, etc. The signal from a single point in the circuit under test can be connected to the EXT TRIG INPUT connector through a signal probe or cable. The sweep is then triggered by the same signal at all times and allows amplitude, time relationship or waveshape changes of signals at various points in the circuit to be examined without resetting the trigger controls.

**EXT ÷ 10.** Operation in the EXT ÷ 10 position is the same as described for EXT except that the external triggering signal is attenuated 10 times. Attenuation of high-amplitude external trigger signals is desirable to broaden the range of the Triggering LEVEL control. When the COUPLING switch is set to LF REJ, attenuation is about 20:1.

### Trigger Coupling

Four methods of coupling the trigger signal to the trigger circuits can be selected with the Triggering COUPLING switches. Each position permits selection or rejection of the frequency components of the trigger signal which will trigger the sweep. Fig. 2-10 graphically illustrates the band of frequencies which each position of the coupling switch covers.

**AC.** The AC position blocks the DC component of the trigger signal. Signals with low-frequency components below about 30 hertz are attenuated. In general, AC coupling can be used for most applications. However, if the trigger signal contains unwanted frequency components or if the sweep is to be triggered at a low repetition rate or a DC level, one of the remaining COUPLING switch positions will provide a better display.

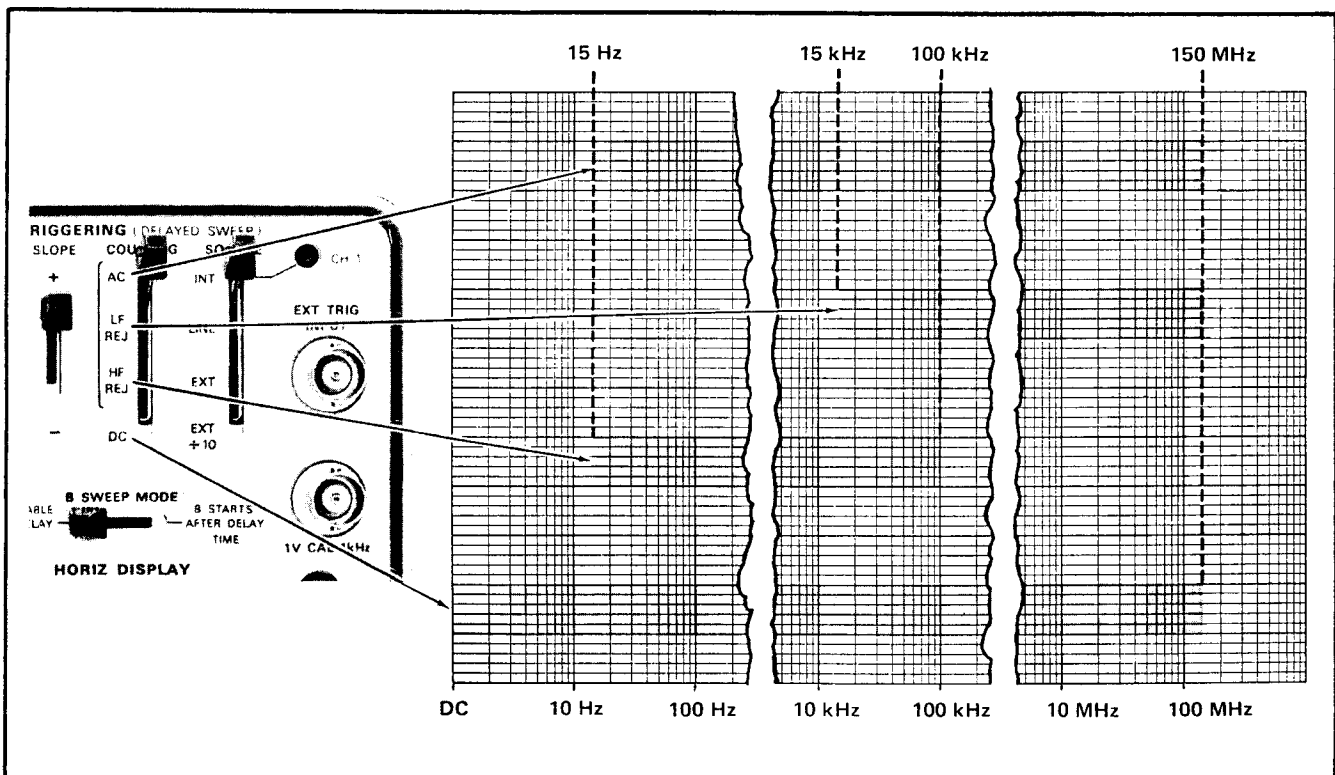

Fig. 2-10. Frequency range of each position of the A and B TRIGGERING COUPLING switches.

The triggering point in the AC position depends on the average voltage level of the trigger signal. If the trigger signals occur in a random fashion, the average voltage level will vary, causing the triggering point to vary also. This shift of the triggering point may be enough so it is impossible to maintain a stable display. In such cases, use DC coupling.

**LF REJ.** In the LF REJ position, DC is rejected and signals below about 50 kilohertz are attenuated. Therefore, the sweep will be triggered only by the higher-frequency components of the signal. This position is particularly useful for providing stable triggering if the trigger contains line-frequency components. Also, in the ALT position of the MODE switch, the LF REJ position provides the best display at fast sweep rates when comparing two unrelated signals (TRIGGER switch set to NORM).

**HF REJ.** The HF REJ position passes all low-frequency signals between about 30 hertz and 50 kilohertz. DC is rejected and signals outside the above range are attenuated. When triggering from complex waveforms, this position is useful for providing stable display of the low-frequency components.

**DC.** DC coupling can be used to provide stable triggering with low-frequency signals which would be attenuated in the AC position, or with low-repetition rate signals. The LEVEL control can be adjusted to provide triggering at the desired DC level on the waveform. When using internal triggering, the setting of the CH 1 and CH 2 POSITION controls affect the DC triggering level.

DC trigger coupling should not be used in the ALT dual-trace mode if the TRIGGER switch is set to NORM. If used, the sweep will trigger on the DC level of one trace and then either lock out completely or free run on the other trace. Correct DC triggering for this mode can be obtained with the TRIGGER switch set to CH 1 ONLY.

### Trigger Slope

The Triggering SLOPE switch determines whether the trigger circuit responds on the positive-going or negative-going portion of the trigger signal. When the SLOPE switch is in the + (positive-going) position, the display starts with the positive-going portion of the waveform; in the - (negative-going) position, the display starts with the negative-going portion of the waveform (see Fig. 2-11). When several cycles of a signal appear in the display, the setting of the SLOPE switch is often unimportant. However, if only a certain portion of a cycle is to be displayed, correct setting of the SLOPE switch is important to provide a display which starts on the desired slope of the input signal.

### Trigger Level

The Triggering LEVEL control determines the voltage level on the triggering waveform at which the sweep is triggered. When the LEVEL control is set in the + region, the trigger circuit responds at a more positive point on the trigger signal. When the LEVEL control is set in the - region, the trigger circuit responds at a more negative point on the trigger signal. Fig. 2-11 illustrates this effect with different settings of the SLOPE switch.

To set the LEVEL control, first select the Triggering SOURCE, COUPLING and SLOPE and MODE. Then set the LEVEL control fully clockwise and rotate it clockwise until the display starts at the desired point.

### High-Frequency Stability

The HF STAB control (A only) is most useful at frequencies above about 40 megahertz or with signals which contain high-frequency components. If a stable display cannot be obtained using the A LEVEL control (trigger signal must have adequate amplitude), adjust the HF STAB control for minimum horizontal jitter in the display.

### A Sweep Triggered Light

The A SWEEP TRIG'D light provides a convenient indication of the condition of the A Triggering circuit. If the A Triggering controls are correctly adjusted with an adequate trigger signal applied, this light is on. However, if the A LEVEL control is misadjusted, the A COUPLING or A SOURCE switches incorrectly set, or the trigger signal too low in amplitude, the A SWEEP TRIG'D light will be off. This feature can be used as a general indication of correct triggering. It is particularly useful when setting up the trigger circuits when a trigger signal is available without a trace display on the CRT; it also indicates that the A sweep is correctly triggered when operating in the B (DELAYED SWEEP) mode.

### A Sweep Mode

**Auto Trig.** The AUTO TRIG position of the A SWEEP MODE switch provides a stable display when the A LEVEL control is correctly set (see Trigger Level in this section) and a trigger signal is available. The A SWEEP TRIG'D light indicates when the A Sweep Generator is triggered.

When the trigger repetition rate is less than about 20 hertz, or in the absence of an adequate trigger signal, the A Sweep Generator free runs to produce a reference trace. When an adequate trigger signal is again applied, the free-running condition ends and the A Sweep Generator is triggered to produce a stable display (with correct LEVEL control setting).



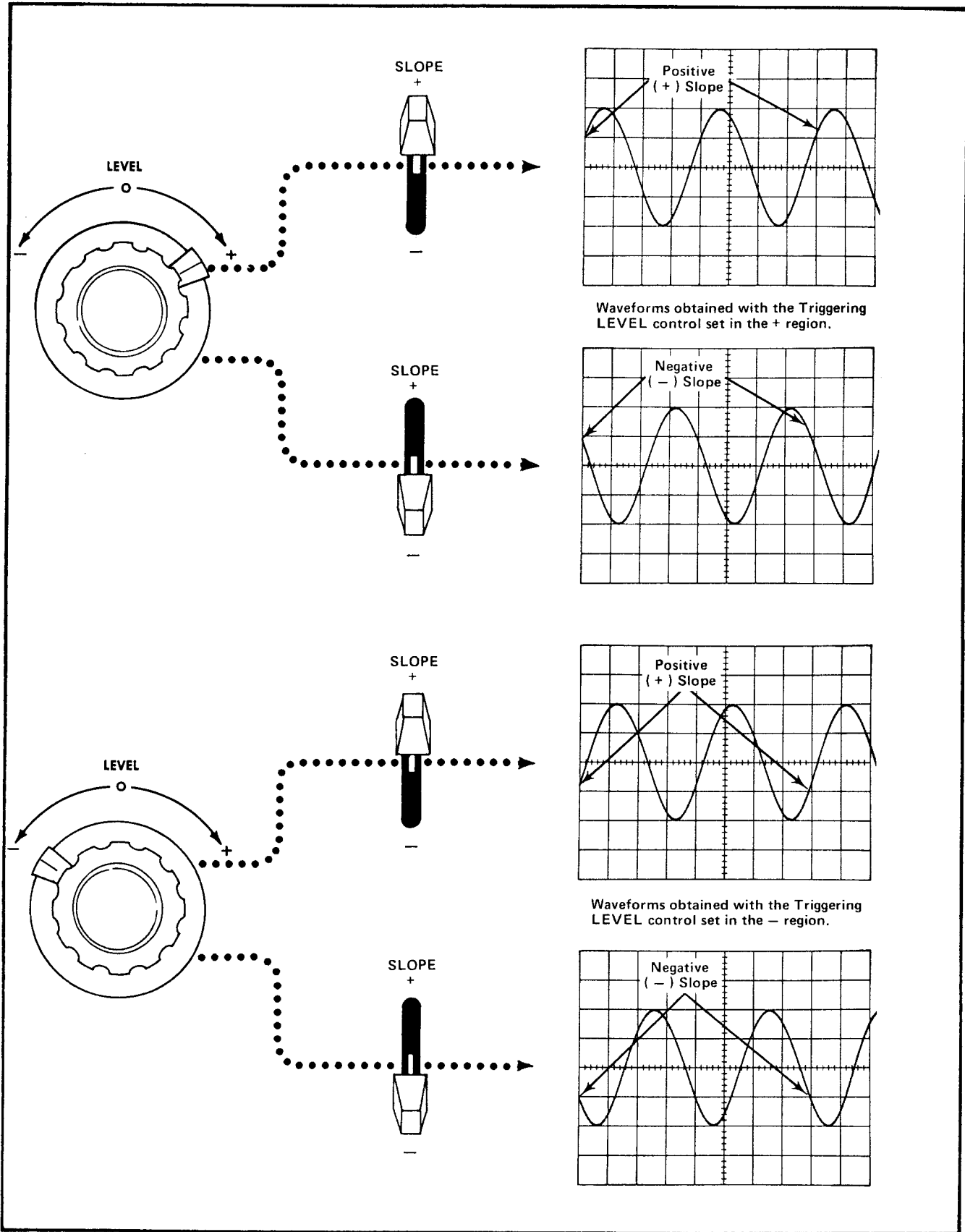

Fig. 2-11. Effects of LEVEL control and the A and B SLOPE switch on displayed waveform.

**NORM TRIG.** Operation in the NORM TRIG position when a trigger signal is applied is the same as in the AUTO TRIG position. However, when a trigger signal is not present, the A Sweep Generator remains off and there is no display. The A SWEEP TRIG'D light indicates when the A Sweep Generator is triggered.

Use the NORM TRIG mode to display signals with repetition rates below about 20 hertz. This mode provides an indication of an adequate trigger signal as well as the correctness of trigger control settings, since there is no display without proper triggering. Also, the A SWEEP TRIG'D light is off when the A sweep is not correctly triggered.

**SINGLE SWEEP.** When the signal to be displayed is not repetitive or varies in amplitude, shape or time, a conventional repetitive display may produce an unstable presentation. To avoid this, use the single-sweep feature of the 454A. The SINGLE SWEEP mode can also be used to photograph a non-repetitive signal.

To use the SINGLE SWEEP mode, first make sure the trigger circuit will respond to the event to be displayed. Set the A SWEEP MODE switch to AUTO TRIG or NORM TRIG and obtain the best possible display in the normal manner (for random signals set the trigger circuit to trigger on a signal which is approximately the same amplitude and frequency as the random signal). Then, set the A SWEEP MODE switch to SINGLE SWEEP and press the RESET button. When the RESET button is pushed, the next trigger pulse initiates the sweep and a single trace will be presented on the screen. After this sweep is complete, the A Sweep Generator is "locked out" until reset. The RESET light located inside the RESET button lights when the A Sweep Generator circuit has been reset and is ready to produce a sweep; it goes out after the sweep is complete. To prepare the circuit for another single-sweep display, press the RESET button again.

**Horizontal Sweep Rates**

The A AND B TIME/DIV switches select calibrated sweep rates for the Sweep Generators. The A and B VARIABLE controls provide continuously variable sweep rates between the settings of the TIME/DIV switches. Whenever the UNCAL A OR B light is on, the sweep rate of either A or B Sweep Generator, or both, is uncalibrated. The light is off when the A VARIABLE (front panel) and B TIME/DIV VARIABLE (side panel) controls are both set to the CAL position.

The sweep rate of the A Sweep Generator is bracketed by the two black lines on the clear plastic inner flange of the TIME/DIV switch (see Fig. 2-12). The B Sweep

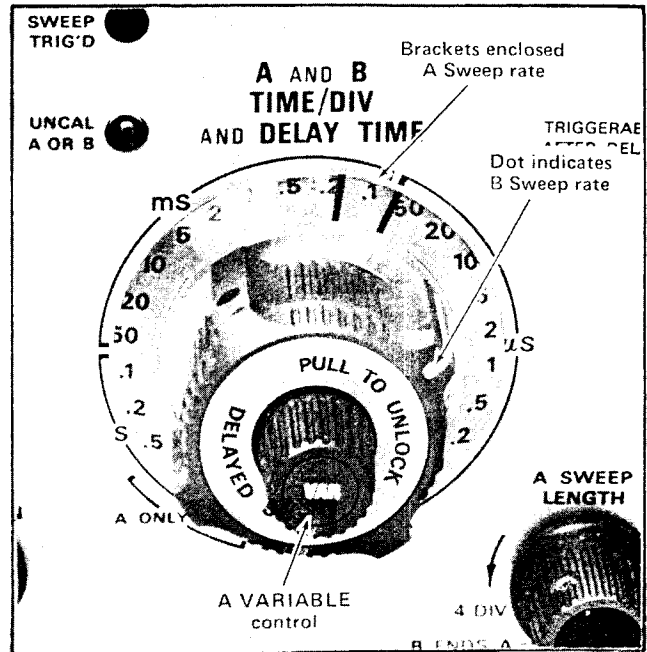

Fig. 2-12. A and B TIME/DIV switch.

Generator sweep rate is indicated by the dot on the DELAYED SWEEP knob. When the dot on the outer knob is set to the same position as the lines on the inner knob, the two knobs lock together and the sweep rate of both Sweep Generators is changed at the same time. However, when the DELAYED SWEEP knob is pulled outward, the inner flange is disengaged and only the B Sweep Generator sweep rate is changed. This allows changing the delayed sweep rate without changing the delay time determined by the A Sweep Generator.

When making time measurements from the graticule, the area between the first-division and ninth-division vertical lines provides the most linear time measurement (see Fig. 2-13). Therefore, the first and last division of the display should not be used when making accurate time measurements.

**Sweep Magnification**

The sweep magnifier expands the sweep ten times. The center division of the unmagnified display is the portion visible on the screen in magnified form (see Fig. 2-14). Equivalent length of the magnified sweep is more than 100 divisions; any 10-division portion may be viewed by adjusting the horizontal POSITION control to bring the desired portion onto the viewing area. The FINE (position) control is particularly useful when the magnifier is on, as it provides positioning in smaller increments for more precise control.

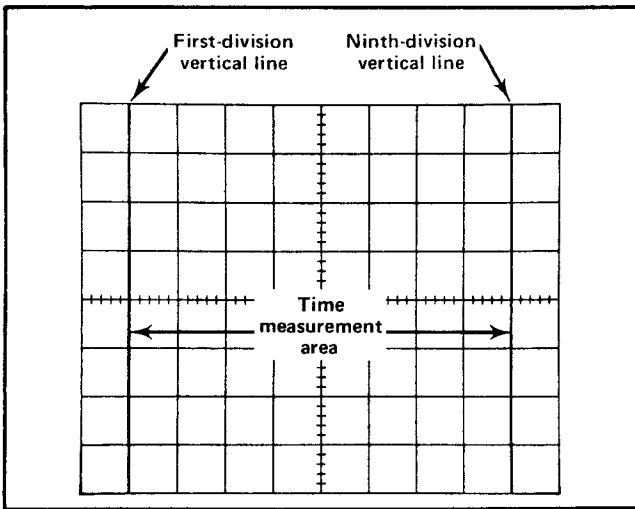

Fig. 2-13. Area of graticule used for accurate time measurements.

To use the magnified sweep, first move the portion of the display which is to be expanded, to the center of the graticule. Then set the MAG switch to X10. The FINE position control can be adjusted to move the magnified portion to the desired position. The light located below the MAG switch is on whenever the magnifier is on.

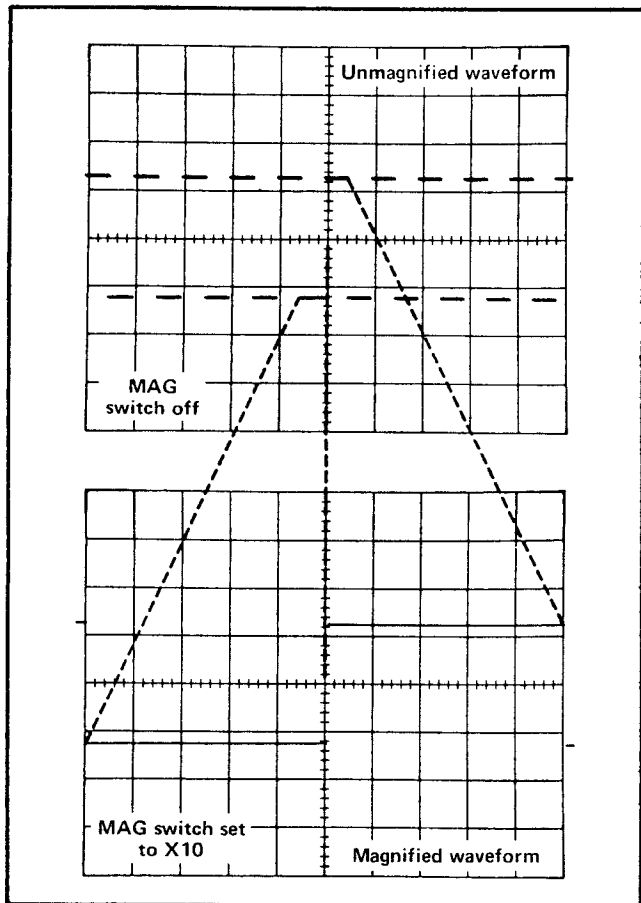

Fig. 2-14. Operation of sweep magnifier.

When the MAG switch is set to X10, the sweep rate is determined by dividing the TIME/DIV switch setting by 10. For example, if the TIME/DIV switch is set to  $.5 \mu\text{s}$ , the magnified sweep rate is 0.05 microsecond/division. The magnified sweep rate must be used for all time measurements when the MAG switch is set to X10. The magnified sweep rate is calibrated when the UNCAL A OR B light is off.

### B (Delayed Sweep)

The B sweep (delayed sweep) is operable in the A INTEN DURING B, B (DELAYED SWEEP), and MIXED positions of the HORIZ DISPLAY switch. The A sweep rate along with the DELAY-TIME MULTIPLIER dial determines the time that the B sweep is delayed. Sweep rate of the delayed portion is determined by the B TIME/DIV (DELAYED SWEEP) switch setting.

In the A INTEN DURING B position, the display will appear similar to Fig. 2-15A. The amount of delay time between the start of A sweep and the intensified portion is

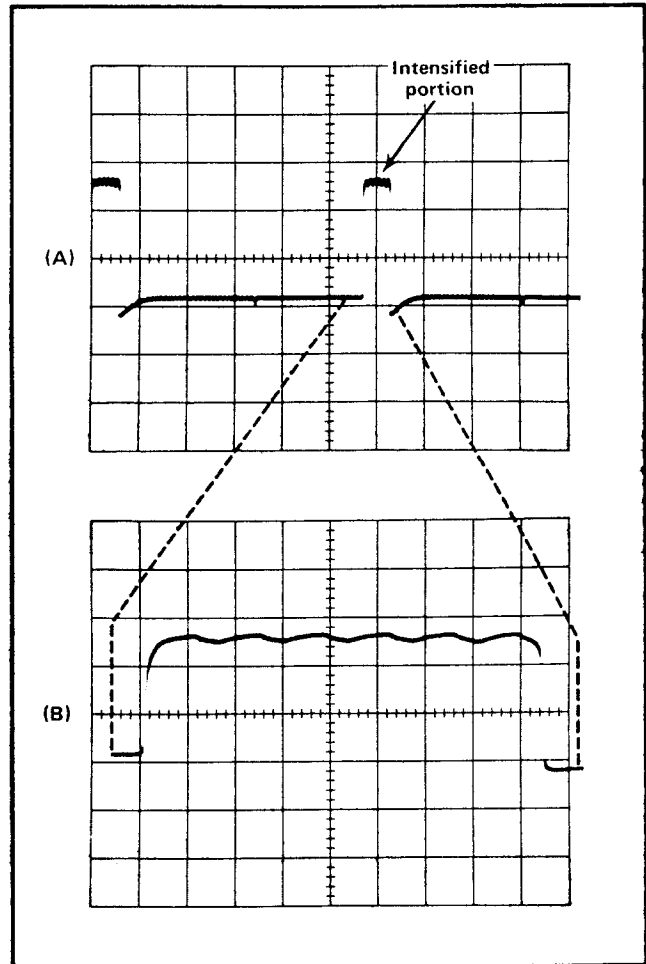

Fig. 2-15. (A) A INTEN DURING B display (A TIME/DIV,  $.5 \text{ ms}$ ; B TIME/DIV,  $50 \mu\text{s}$ ), (B) B (DELAYED SWEEP) display.

determined by the setting of the A TIME/DIV switch and the DELAY-TIME MULTIPLIER dial. For example, the delay time indicated by the DELAY-TIME MULTIPLIER dial setting shown in Fig. 2-16 is 3.55; this corresponds to 3.55 CRT divisions of A sweep. This reading multiplied by the setting of the A TIME/DIV switch gives the calibrated delay time before the start of the B sweep (Note: Due to system time delays, the delay start determined by the A sweep is accurate only between 50 seconds and one microsecond). The intensified portion of the display is produced by the B sweep. The length of this portion is about 10 times the setting of the B TIME/DIV switch.

When the HORIZ DISPLAY switch is set to B (DELAYED SWEEP), only the intensified portion (as viewed in the A INTEN DURING B position) is displayed on the screen at the sweep rate indicated by the B TIME/DIV switch (see Fig. 2-15B).

The MIXED position of the HORIZ DISPLAY switch provides a CRT display containing more than one time factor on the horizontal axis. The first part of the display will be at a sweep rate set by the A TIME/DIV switch and for a time duration determined by the setting of the DELAY-TIME MULTIPLIER control. The latter part of the display will be at a sweep rate set by the B TIME/DIV switch. Fig. 2-17 illustrates a typical mixed sweep display.

**B Sweep Mode.** The B SWEEP MODE switch provides two modes of delayed sweep. Fig. 2-18 illustrates the difference between these two modes. In the B STARTS AFTER DELAY TIME position, the B sweep is presented immediately after the delay time (see Fig. 2-18A). The B sweep is triggered at a selected level on A sweep to provide a delay for B sweep. Since this delay time is the same for each sweep, the display appears stable. In the TRIGGERABLE AFTER DELAY TIME position, the B sweep

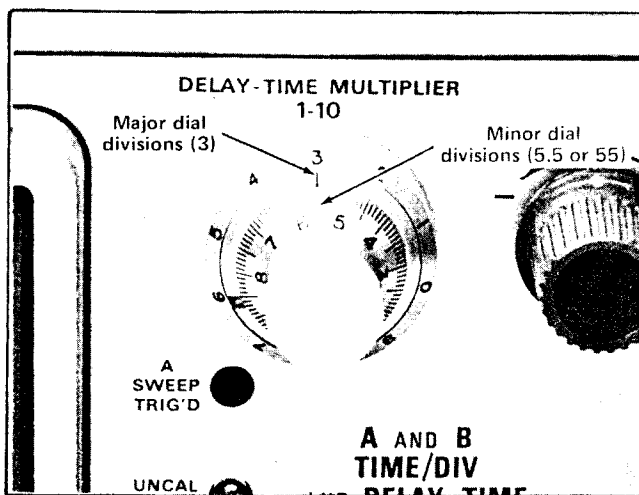

Fig. 2-16. DELAY-TIME MULTIPLIER dial. Reading shown: 3.55.

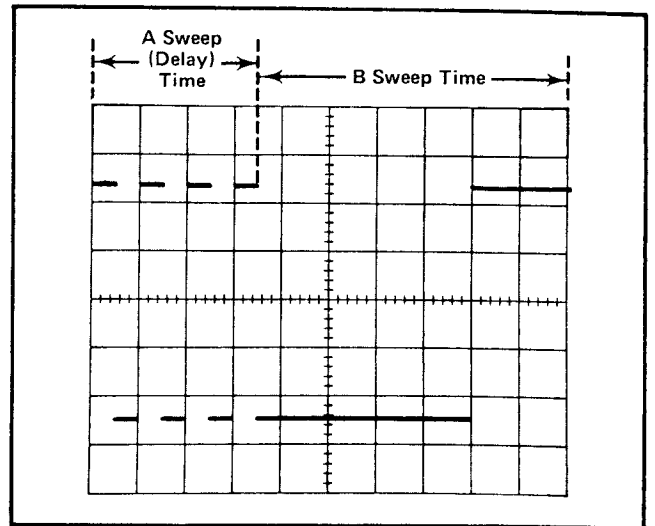

Fig. 2-17. A typical mixed sweep display (A TIME/DIV set to 1 ms, B TIME/DIV set to .1 ms, and the DELAY-TIME MULTIPLIER dial set to 3.55).

operates only when it is triggered after the selected delay time (see Fig. 2-18B). The B Triggering controls operate as described in this section.

**Delayed/Mixed Sweep Operation.** To obtain a delayed sweep display, use the following procedure:

1. Set the HORIZ DISPLAY switch to A INTEN DURING B.
2. Set the B SWEEP MODE switch to the desired setting. If TRIGGERABLE AFTER DELAY TIME is used, correct B Triggering is also necessary.
3. Set the delay time with the A TIME/DIV switch and the DELAY-TIME MULTIPLIER dial.
4. Pull the DELAYED SWEEP (B TIME/DIV) knob out and set to the desired sweep rate.
5. If the TRIGGERABLE AFTER DELAY TIME position is used, check the display for an intensified portion. Absence of the intensified zone indicates that B sweep is not correctly triggered.
6. Set the HORIZ DISPLAY switch to B (DELAYED SWEEP). The intensified zone shown in the A INTEN DURING B position is now displayed at the sweep rate selected by the B TIME/DIV switch.

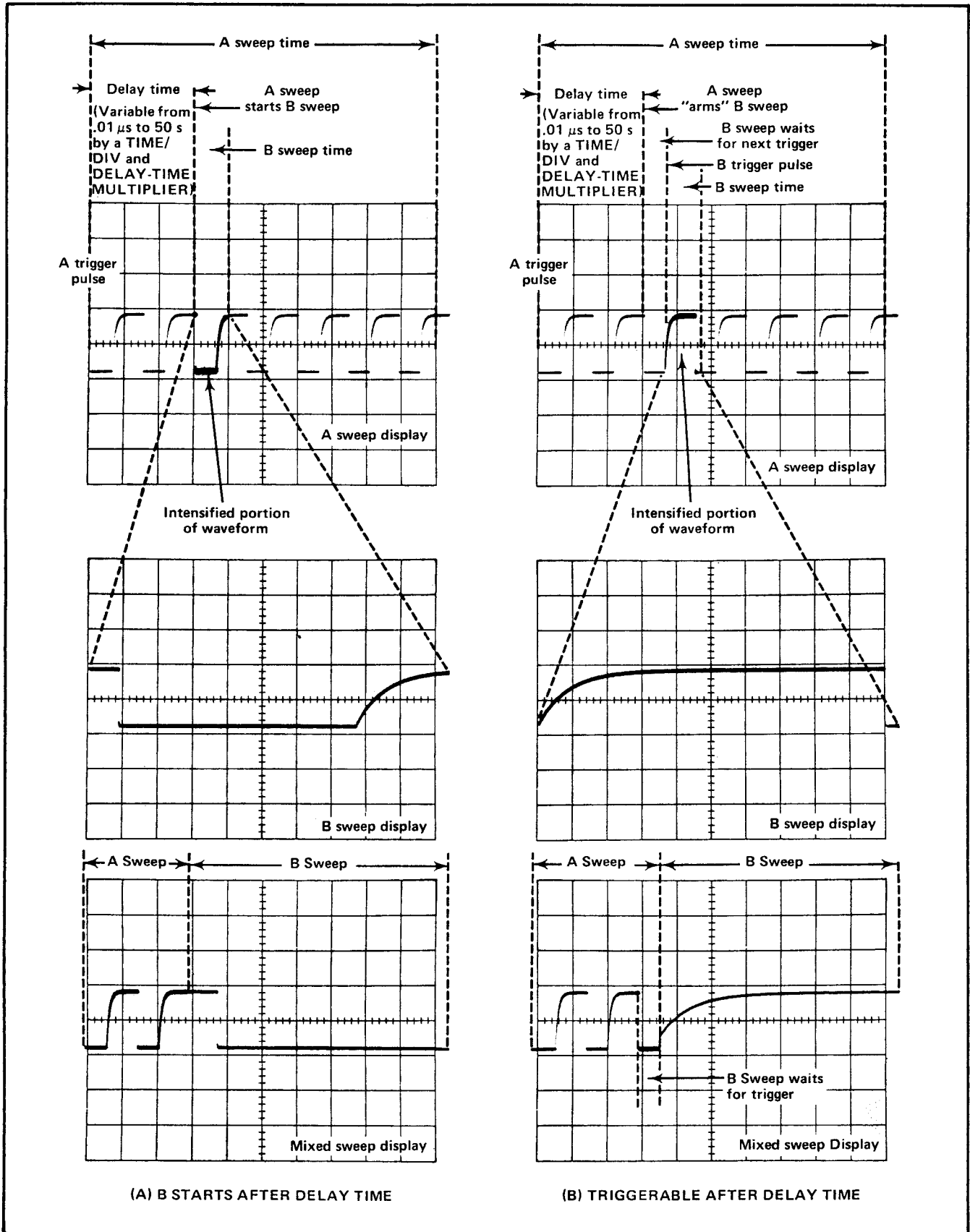

Fig. 2-18. Comparison of the delayed-sweep modes. (A) B STARTS AFTER DELAY TIME, (B) TRIGGERABLE AFTER DELAY TIME. In each display the B sweep is delayed a selected amount of time by the A sweep.

7. Set the HORIZ DISPLAY switch to MIXED. The first part of the display will be at a sweep rate set by the A TIME/DIV switch, and the latter part of the display will be at a sweep rate set by the B TIME/DIV switch.

Several examples of uses of the delayed sweep feature are given under Basic Applications in this section.

**A Sweep Length.** The A SWEEP LENGTH control is most useful when used with delayed sweep. As this control is rotated counterclockwise from the FULL position, the length of the A sweep decreases until it is about four divisions long near the counterclockwise position (not in B ENDS A detent). The B ENDS A position produces a display which ends immediately following the B sweep (B sweep must end before the normal end of A sweep). The A SWEEP LENGTH control effectively increases the repetition rate of delayed sweep displays.

To use the A SWEEP LENGTH control, set the HORIZ DISPLAY switch to A INTEN DURING B and set the delay time and delayed sweep rate in the normal manner. Turn the A SWEEP LENGTH control counterclockwise until the sweep ends immediately following the intensified portion of the display. Then, set the HORIZ DISPLAY switch to B (DELAYED SWEEP). This method provides the maximum repetition rate for a given delayed sweep display. In the B ENDS A position, the maximum repetition rate is maintained automatically.

#### NOTE

*Jitter can be introduced into the display and incorrect displays produced through the wrong usage of the A SWEEP LENGTH control. When using this control, first obtain the best possible display in the FULL position. Then, set the control for the desired A sweep length. If jitter is evident in the display, readjust the Triggering controls or change the A SWEEP LENGTH control to a position that does not cause jitter.*

### X-Y Operation

In some applications, it is desirable to display one signal versus another (X-Y) rather than against time (internal sweep). The X-Y position of the HORIZ DISPLAY switch provides a means for applying an external signal to the horizontal amplifier for this type of display.

When the HORIZ DISPLAY switch is set to X-Y and the TRIGGER switch is set to CH 1 ONLY OR X-Y, the horizontal (X-axis) deflection is provided by the signal connected to the INPUT CH 1 or X connector and the vertical deflection is provided by the signal connected to

the INPUT CH 2 or Y connector. The calibrated X-axis deflection is indicated by the CH 1 VOLTS/DIV switch; calibrated Y-axis deflection is indicated by the CH 2 VOLTS/DIV switch. For X-Y operation, the CH 1 POSITION control provides X-axis positioning and the CH 2 POSITION control provides Y-axis positioning.

Do not exceed the horizontal scan area of the graticule in the X-Y mode of operation. This mode can be used to measure phase differences up to about two megahertz. Above this frequency, the inherent phase shift in the system makes phase measurement difficult. To aid in interpreting lissajous displays, refer to the reference books listed under Applications.

To check and adjust the X-axis deflection accuracy, use the following procedure (Y-axis deflection accuracy is checked as given for vertical deflection under Vertical Gain Adjustment).

1. Set the HORIZ DISPLAY switch to X-Y.
2. Set the TRIGGER switch to CH 1 ONLY OR X-Y.
3. Connect the 1 V CAL 1 kHz connector to the INPUT CH 1 or X connector with a BNC cable.
4. Set the CH 1 VOLTS/DIV switch to .2.
5. Advance the INTENSITY control until two dots are visible on the CRT.
6. Check that the dots are exactly five divisions apart. If not, adjust the X-GAIN (X-Y) adjustment (side panel) for exactly five divisions of deflection.

### Sweep Generator Output Signals

**A and B + GATE.** The A and B + GATE output connectors (on side panel) provided a rectangular output pulse which is coincident with the sweep time of the respective sweep generator. This rectangular pulse is about +12 volts in amplitude (into high-impedance loads) with pulse duration the same as the respective sweep.

**A Sweep.** The A SWEEP connector (on side panel) provides a sample of the sawtooth sweep signal from the A Sweep Generator circuit. Amplitude of the sweep output signal is about +10 volts into a high-impedance load.

### Intensity Modulation

Intensity (Z-axis) modulation can be used to relate a third item of electrical phenomena to the vertical (Y-axis)

and the horizontal (X-axis) coordinates without affecting the wave shape of the displayed signal. The Z-axis modulating signal applied to the CRT circuit changes the intensity of the displayed waveform to provide this type of display. "Gray scale" intensity modulation can be obtained by applying signals which do not completely blank the display. Large amplitude signals of the correct polarity will completely blank the display; the sharpest display is provided by signals with a fast rise and fall. The voltage amplitude required for visible trace modulation depends on the setting of the INTENSITY control. At normal intensity level, a five-volt peak-to-peak signal produces a visible change in brightness. When the Z AXIS INPUT connector is not in use, keep the ground strap in place.

Time markers applied to the Z AXIS INPUT connector provide a direct time reference on the display. With uncalibrated horizontal sweep or X-Y mode operation, the time markers provide a means of reading time directly from the display. However, if the markers are not time-related to the displayed waveform, a single-sweep display should be used (for internal sweep only) to provide a stable display.

### Calibrator

The one-kilohertz square-wave Calibrator of the 454A provides a convenient signal source for checking basic vertical gain and sweep timing. However, to provide maximum measurement accuracy, the adjustment procedure given in the Calibration section of this manual should be used when recalibrating the unit. The Calibrator output signal is also very useful for adjusting probe compensation as described in the probe instruction manual. In addition, the Calibrator can be used as a convenient signal source for application to external equipment.

**Voltage.** The Calibrator provides an accurate peak-to-peak square-wave voltage of one volt into a high impedance load. Output resistance is 250 ohms. The actual voltage across an external load resistor can be calculated in the same manner as with any series resistor combination (necessary only if the load resistance is less than about 50 kilohms).

**Current.** The current loop, located on the side panel, provides a five milliampere peak-to-peak square-wave current which can be used to check and calibrate current-measuring probe systems. This current signal is obtained by clipping the probe around the current loop. The arrow above the PROBE LOOP indicates conventional current flow; i.e., from + to -.

**Frequency.** The Calibrator circuit uses frequency-stable components to maintain accurate frequency and constant duty cycle. Thus the Calibrator can be used for checking the basic sweep timing of the horizontal system.

**Wave shape.** The square-wave output signal of the Calibrator can be used as a reference wave shape when checking or adjusting the compensation of passive, high-resistance probes. Since the square-wave output from the Calibrator has a flat top, any distortion in the displayed waveform is due to the probe compensation.

## APPLICATIONS

### General

The following information describes the procedures and techniques for making basic measurements with a 454A Oscilloscope. These applications are not described in detail, since each application must be adapted to the requirements of the individual measurements. This instrument can also be used for many applications which are not described in this manual. Contact your local Tektronix Field Office or representative for assistance in making specific measurements with this instrument. Also, the following books describe oscilloscope measurement techniques which can be adapted for use with this instrument.

Harley Carter, "An Introduction to the Cathode Ray Oscilloscope", Philips Technical Library, Cleaver-Hume Press Ltd., London, 1960.

J. Czech, "Oscilloscope Measuring Technique", Philips Technical Library, Springer-Verlag, New York, 1965.

Robert G Middleton and L. Donald Payne, "Using the Oscilloscope in Industrial Electronics", Howard W. Sams & Co. Inc., The Bobbs-Merrill Company Inc., Indianapolis, 1961.

John F. Rider and Seymour D. Uslan, "Encyclopedia of Cathode-Ray Oscilloscopes and Their Uses", John F. Rider Publisher Inc., New York, 1959.

John F. Rider, "Obtaining and Interpreting Test Scope Traces", John F. Rider Publisher Inc., New York, 1959.

Rufus P. Turner, "Practical Oscilloscope Handbook", Volumes 1 and 2, John F. Rider Publisher Inc., New York, 1964.

### Peak-to-Peak Voltage Measurements—AC

To make a peak-to-peak voltage measurements, use the following procedure:

1. Connect the signal to either INPUT connector.

## Operating Instructions—454A/R454A

2. Set the MODE switch to display the channel used.
3. Set the VOLTS/DIV switch to display about five divisions of the waveform.
4. Set the Input Coupling switch to AC.

### NOTE

*For low-frequency signals below about 10 hertz, use the DC position.*

5. Set the A Triggering controls to obtain a stable display. Set the TIME/DIV switch to a position that displays several cycles of the waveform.

6. Turn the vertical POSITION control so the lower portion of the waveform coincides with one of the graticule lines below the center horizontal line, and the top of the waveform is on the viewing area. Move the display with the horizontal POSITION control, so one of the upper peaks lies near the center vertical line (see Fig. 2-19).

7. Measure the divisions of vertical deflection from peak to peak. Make sure the VARIABLE VOLTS/DIV control is in the CAL position.

### NOTE

*This technique may also be used to make measurements between two points on the waveform rather than peak to peak.*

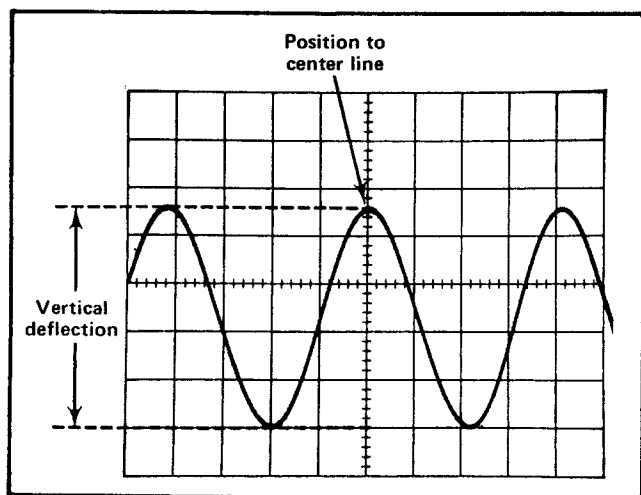

Fig. 2-19. Measuring peak-to-peak voltage of a waveform.

8. Multiply the distance measured in step 7 by the VOLTS/DIV switch setting. Also include the attenuation factor of the probe, if any.

**Example.** Assume a peak-to-peak vertical deflection of 4.6 divisions (see Fig. 2-19) using a 10X attenuator probe and a VOLTS/DIV switch setting of .5.

Using the formula:

$$\text{Volts Peak to Peak} = \text{vertical deflection (divisions)} \times \text{VOLTS/DIV setting} \times \text{probe attenuation factor}$$

Substituting the given values:

$$\text{Volts Peak to Peak} = 4.6 \times 0.5 \text{ V} \times 10$$

The peak-to-peak voltage is 23 volts.

## Instantaneous Voltage Measurements—DC

To measure the DC level at a given point on a waveform, use the following procedure:

1. Connect the signal to either INPUT connector.
2. Set the MODE switch to display the channel used.
3. Set the VOLTS/DIV switch to display about five divisions of the waveform.
4. Set the Input Coupling switch to GND.
5. Set the A SWEEP MODE switch to AUTO TRIG.
6. Position the trace to the bottom line of the graticule or other reference line. If the voltage to be measured is negative with respect to ground, position the trace to the top line of the graticule. Do not move the vertical POSITION control after this reference line has been established.

### NOTE

*To measure a voltage level with respect to a voltage other than ground, make the following changes in step 6: Set the Input Coupling switch to DC and apply the reference voltage to the INPUT connector. Then position the trace to the reference line.*



7. Set the Input Coupling switch to DC. The ground reference line can be checked at any time by switching to the GND position.

8. Set the A Triggering controls to obtain a stable display. Set the TIME/DIV switch to a setting that displays several cycles of the signal.

9. Measure the distance in divisions between the reference line and the point on the waveform at which the DC level is to be measured. For example, in Fig. 2-20 the measurement is made between the reference line and point A.

10. Establish the polarity of the signal. If the waveform is above the reference line, the voltage is positive; below the line, negative (when the INVERT switch is pushed in if using Channel 2).

11. Multiply the distance measured in step 9 by the VOLTS/DIV switch setting. Include the attenuation factor of the probe if any.

**Example.** Assume that the vertical distance measured is 4.6 divisions (see Fig. 2-20), the waveform is above the reference line, using a 10X attenuator probe and a VOLTS/DIV switch setting of 2.

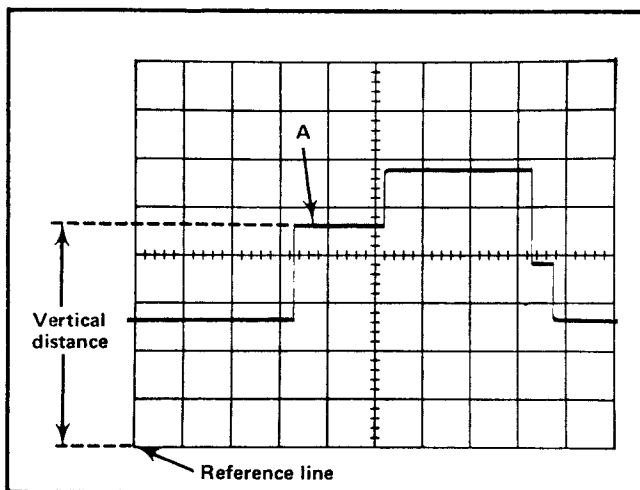

Fig. 2-20. Measuring instantaneous DC voltage with respect to a reference voltage.

Using the formula:

$$\text{Instantaneous Voltage} = \text{vertical distance (divisions)} \times \text{polarity} \times \text{VOLTS/DIV setting} \times \text{probe attenuation factor}$$

Substituting the given values:

$$\text{Instantaneous Voltage} = 4.6 \times +1 \times 2 \text{ V} \times 10$$

The instantaneous voltage is +92 volts.

### Comparison Measurements

In some applications it may be desirable to establish arbitrary units of measurement other than those indicated by the VOLTS/DIV switch or TIME/DIV switch. This is particularly useful when comparing unknown signals to a reference amplitude or repetition rate. One use for the comparison-measurement technique is to facilitate calibration of equipment (e.g., on an assembly-line test) where the desired amplitude or repetition rate does not produce an exact number of divisions of deflection. The adjustment will be easier and more accurate if arbitrary units of measurement are established so that correct adjustment is indicated by an exact number of division of deflection. Arbitrary sweep rates can be useful for comparing harmonic signals to a fundamental frequency, or for comparing the repetition rate of the input and output pulses in a digital count-down circuit. The following procedure describes how to establish arbitrary units of measure for comparison measurements. Although the procedure for establishing vertical and horizontal arbitrary units of measurement is much the same, both processes are described in detail.

**Vertical Deflection Factor.** To establish an arbitrary vertical deflection factor based upon a specific reference amplitude, proceed as follows:

1. Connect the reference signal to the INPUT connector. Set the TIME/DIV switch to display several cycles of the signal.

2. Set the VOLTS/DIV switch and the VARIABLE VOLTS/DIV control to produce a display an exact number of graticule divisions in amplitude. Do not change the VARIABLE VOLTS/DIV control after obtaining the desired deflection. This display can be used as a reference for amplitude comparison measurements.

Operating Instructions—454A/R454A

3. To establish an arbitrary vertical deflection factor so the amplitude of an unknown signal can be measured accurately at any setting of the VOLTS/DIV switch, the amplitude of the reference signal must be known. If it is not known, it can be measured before the VARIABLE VOLTS/DIV control is set in step 2.

4. Divide the amplitude of the reference signal (volts) by the product of the vertical deflection established in step 2 (divisions) and the setting of the VOLTS/DIV switch. This is the vertical conversion factor.

$$\text{Vertical Conversion Factor} = \frac{\text{reference signal amplitude (volts)}}{\text{vertical deflection (divisions) X VOLTS/DIV switch setting}}$$

5. To measure the amplitude of an unknown signal, disconnect the reference signal and connect the unknown signal to the INPUT connector. Set the VOLTS/DIV switch to a setting that provides sufficient vertical deflection to make an accurate measurement. Do not readjust the VARIABLE VOLTS/DIV control.

6. Measure the vertical deflection in divisions and calculate the amplitude of the unknown signal using the following formula.

$$\text{Signal Amplitude} = \text{VOLTS/DIV switch setting} \times \text{vertical conversion factor} \times \text{vertical deflection (divisions)}$$

**Example.** Assume a reference signal amplitude of 30 volts, a VOLTS/DIV switch setting of 5, and the VARIABLE VOLTS/DIV control is adjusted to provide a vertical deflection of four divisions.

Substituting these values in the vertical conversion factor formula (step 4);

$$\text{Vertical Conversion Factor} = \frac{30 \text{ V}}{4 \times 5 \text{ V}} = 1.5$$

Then with a VOLTS/DIV switch setting of 1, the peak-to-peak amplitude of an unknown signal which produces a vertical deflection of five divisions can be determined by using the signal amplitude formula (step 6):

$$\text{Signal Amplitude} = 1 \text{ V} \times 1.5 \times 5 = 7.5 \text{ volts}$$

**Sweep Rates.** To establish an arbitrary horizontal sweep rate based upon a specific reference frequency, proceed as follows:

1. Connect the reference signal to the INPUT connector. Set the VOLTS/DIV switch for four or five divisions of vertical deflection.

2. Set the TIME/DIV switch and the VARIABLE TIME/DIV control so one cycle of the signal covers an exact number of horizontal divisions. Do not change the VARIABLE TIME/DIV control after obtaining the desired deflection. This display can be used as a reference for frequency comparison measurements.

3. To establish an arbitrary sweep rate so the repetition rate of an unknown signal can be measured accurately at any setting of the TIME/DIV switch, the repetition rate of the reference signal must be known. If it is not known, it can be measured before the VARIABLE TIME/DIV switch is set in step 2.

4. Divide the repetition rate of the reference signal (seconds) by the product of the horizontal deflection established in step 2 (divisions) and the setting of the TIME/DIV switch. This is the horizontal conversion factor:

$$\text{Horizontal Conversion Factor} = \frac{\text{reference signal repetition rate (seconds)}}{\text{horizontal deflection (divisions) X TIME/DIV switch setting}}$$

5. To measure the repetition rate of an unknown signal, disconnect the reference signal and connect the unknown signal to the INPUT connector. Set the TIME/DIV switch to a setting that provides sufficient horizontal deflection to make an accurate measurement. Do not readjust the VARIABLE TIME/DIV control.

6. Measure the horizontal deflection in divisions and calculate the repetition rate of the unknown signal using the following formula:

$$\text{Repetition Rate} = \text{TIME/DIV switch setting} \times \text{horizontal conversion factor} \times \text{horizontal deflection (divisions)}$$

**NOTE**

*If the horizontal magnifier is used be sure to use the magnified sweep rate in place of the TIME/DIV switch setting.*

**Example.** Assume a reference signal frequency of 455 hertz (repetition rate 2.19 milliseconds), and a TIME/DIV switch setting of .2 ms, with the VARIABLE TIME/DIV control adjusted to provide a horizontal deflection of eight divisions. Substituting these values in the horizontal conversion factor formula (step 4):

$$\text{Horizontal Conversion Factor} = \frac{2.19 \text{ milliseconds}}{.2 \times 8} = 1.37$$

Then, with a TIME/DIV switch setting of 50 μs the repetition rate of an unknown signal which completes one cycle is seven horizontal divisions can be determined by using the repetition rate formula (step 6):

$$\text{Repetition Rate} = 50 \mu\text{s} \times 1.37 \times 7 = 480 \mu\text{s}$$

This answer can be converted to frequency by taking the reciprocal of the repetition rate (see applications on Determining Frequency).

### Time-Duration Measurements

To measure time between two points on a waveform, use the following procedure:

1. Connect the signal to either INPUT connector.
2. Set the MODE switch to display the channel used.
3. Set the VOLTS/DIV switch to display about five divisions of the waveform.
4. Set the A Triggering controls to obtain a stable display.
5. Set the TIME/DIV switch to the fastest sweep rate that displays less than eight divisions between the time measurement points (see Fig. 2-21). See the topic entitled Selecting Sweep Rate in this section concerning non-linearity of first and last divisions of display.
6. Adjust the vertical POSITION control to move the points between which the time measurement is made to the center horizontal line.
7. Adjust the horizontal POSITION control to center the display within the center eight divisions of the graticule.

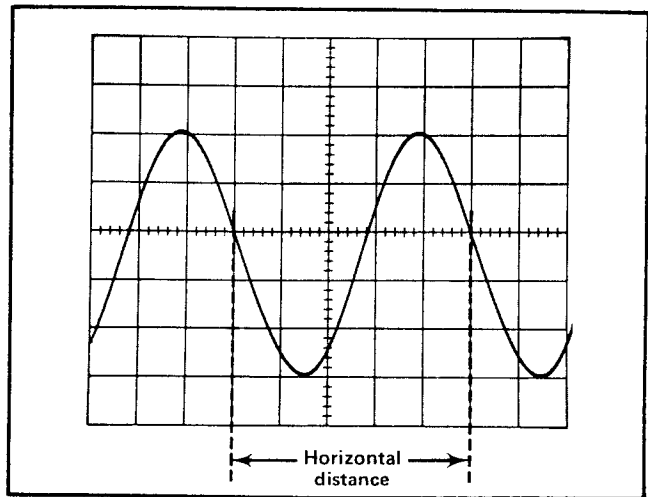

Fig. 2-21. Measuring the time duration between points on a waveform.

8. Measure the horizontal distance between the time measurement points. Be sure the A VARIABLE control is set to CAL.

9. Multiply the distance measured in step 8 by the setting of the TIME/DIV switch. If sweep magnification is used, divide this answer by 10.

**Example.** Assume that the distance between the time measurement points is five divisions (see Fig. 2-21) and the TIME/DIV switch is set to .1 ms with the magnifier off.

Using the formula:

$$\text{Time Duration} = \frac{\text{horizontal distance (divisions)} \times \text{TIME/DIV setting}}{\text{magnification}}$$

Substitute the given values:

$$\text{Time Duration} = \frac{5 \times 0.1 \text{ ms}}{1}$$

The time duration is 0.5 millisecond.

### Frequency Measurement

The time measurement technique can also be used to determine the frequency of a signal. The frequency of a periodically recurrent signal is the reciprocal of the time duration (period) of one cycle.

**Operating Instructions—454A/R454A**

Use the following procedure:

1. Measure the time duration of one cycle of the waveform as described in the previous application.
2. Take the reciprocal of the time duration to determine the frequency.

**Example.** The frequency of the signal shown in Fig. 2-21 which has a time duration of 0.5 millisecond is:

$$\text{Frequency} = \frac{1}{\text{time duration}} = \frac{1}{0.5 \text{ ms}} = 2 \text{ kHz}$$

**Risetime Measurements**

Risetime measurements employ basically the same techniques as time-duration measurements. The main difference is the points between which the measurement is made. The following procedure gives the basic method of measuring risetime between the 10% and 90% points of the waveform. Falltime can be measured in the same manner on the trailing edge of the waveform.

1. Connect the signal to either INPUT connector.
2. Set the MODE switch to display the channel used.
3. Set the VOLTS/DIV switch and the VARIABLE control to produce a display an exact number of divisions in amplitude.
4. Center the display about the center horizontal line.
5. Set the TIME/DIV switch to the fastest sweep rate that displays less than eight divisions between the 10% and 90% points on the waveform.

6. Determine the 10% and 90% points on the rising portion of the waveform. The figures given in Table 2-2 are for the points 10% up from the start of the rising portion and 10% down from the top of the rising portion (90% point).

**TABLE 2-2**

Vertical display (divisions)	10% and 90% points	Divisions vertically between 10% and 90% point
4	0.4 division	3.2
5	0.5 division	4.0
6	0.6 division	4.8

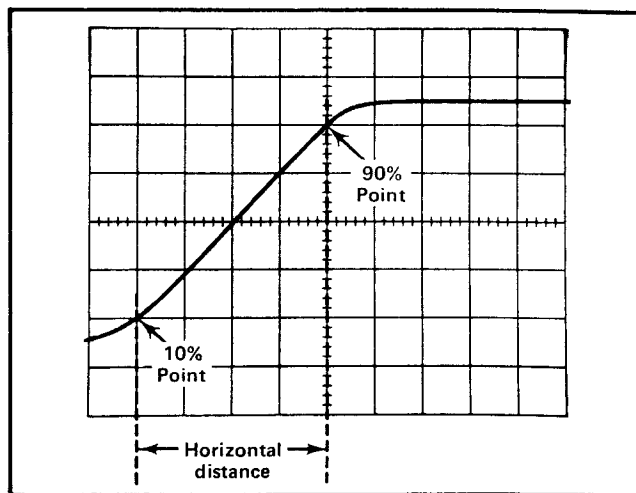

**Fig. 2-22. Measuring risetime.**

7. Adjust the horizontal POSITION control to move the 10% point of the waveform to the first graticule line. For example, with a five-division display as shown in Fig. 2-22, the 10% point is 0.5 division up from the start of the rising portion.
8. Measure the horizontal distance between the 10% and 90% points. Be sure the A VARIABLE control is set to CAL.
9. Multiply the distance measured in step 8 by the setting of the TIME/DIV switch. If sweep magnification is used, divide this answer by 10.

**Example.** Assume that the horizontal distance between the 10% and 90% points is four divisions (see Fig. 2-22) and the TIME/DIV switch is set to 1 μs with the MAG switch set to X10. Applying the time duration formula to risetime:

$$\text{Risetime (Time Duration)} = \frac{\text{horizontal (divisions) distance} \times \text{TIME/DIV setting}}{\text{magnification}}$$

Substituting the given values:

$$\text{Risetime} = \frac{4 \times 1 \mu\text{s}}{10}$$

The risetime is 0.4 microsecond.

### Time-Difference Measurements

The calibrated sweep rate and dual-trace features of the 454A allow measurement of time difference between two separate events. To measure time difference, use the following procedure:

1. Set the Input Coupling switches to the desired coupling positions.

2. Set the MODE switch to either CHOP or ALT. In general, CHOP is more suitable for low-frequency signals and the ALT position is more suitable for high-frequency signals. More information on determining the mode is given under Dual-Trace Operation in this section.

3. Set the TRIGGER switch to CH 1 ONLY.

4. Connect the reference signal to INPUT CH 1 and the comparison signal to INPUT CH 2. The reference signal should precede the comparison signal in time. Use coaxial cables or probes which have equal time delay to connect the signals to the INPUT connectors.

5. If the signals are of opposite polarity, pull out the INVERT switch to invert the Channel 2 display (signals may be of opposite polarity due to 180° phase difference; if so, take this into account in the final calculation).

6. Set the VOLTS/DIV switches to produce four- or five-division displays.

7. Set the A LEVEL control for a stable display.

8. If possible, set the TIME/DIV switch for a sweep rate which shows three or more divisions between the two waveforms.

9. Adjust the vertical POSITION controls to center each waveform (or the points on the display between which the measurement is made) in relation to the center horizontal line.

10. Adjust the horizontal POSITION control so the Channel 1 (reference) waveform crosses the center horizontal line at a vertical graticule line.

11. Measure the horizontal difference between the Channel 1 waveform and the Channel 2 waveform (see Fig. 2-23).

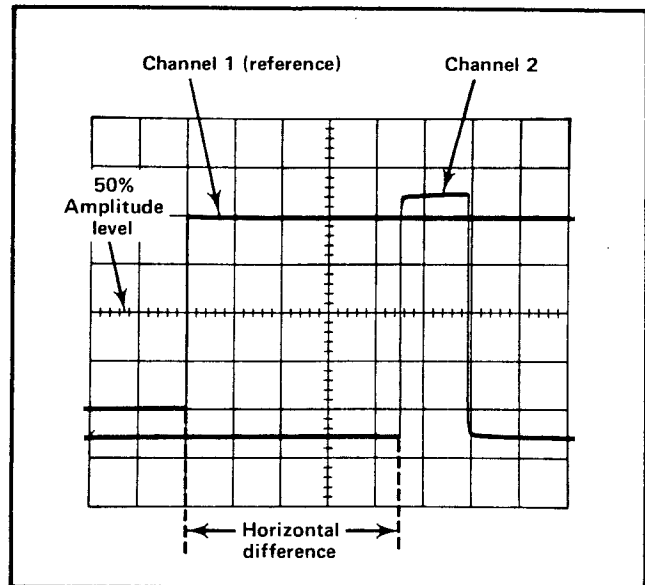

Fig. 2-23. Measuring time difference between two pulses.

12. Multiply the measured difference by the setting of the TIME/DIV switch. If sweep magnification is used, divide this answer by 10.

**Example.** Assume that the TIME/DIV switch is set to 50 μs, the MAG switch to X10 and the horizontal difference between waveforms is 4.5 divisions (see Fig. 2-23).

Using the formula:

$$\text{Time Delay} = \frac{\text{TIME/DIV setting} \times \text{horizontal difference (divisions)}}{\text{magnification}}$$

Substituting the given values:

$$\text{Time Delay} = \frac{50 \mu\text{s} \times 4.5}{10}$$

The time delay is 22.5 microseconds.

### Delayed or Mixed Sweep Time Measurement

The delayed sweep mode can be used to make accurate time measurements. The following measurement determines the time difference between two pulses displayed on the same trace. This application may also be used to measure time difference from two different sources (dual-trace) or to measure time duration of a single pulse.

1. Connect the signal to either INPUT connector. Set the MODE switch to display the channel used.

## Operating Instructions—454A/R454A

2. Set the VOLTS/DIV switch to produce a display about four divisions in amplitude.
3. If possible, set the A TIME/DIV switch to a sweep rate which displays about eight divisions between the pulses.
4. Adjust the A Triggering controls for a stable display.
5. Set the HORIZ DISPLAY switch to A INTEN DURING B and the B SWEEP MODE switch to B STARTS AFTER DELAY TIME.
6. Set the B TIME/DIV switch to a setting 1/1000th of the A TIME/DIV sweep rate. This produces an intensified portion about 0.1 division in length.
7. Turn the DELAY-TIME MULTIPLIER dial to move the intensified portion to the first pulse.
8. Set the HORIZ DISPLAY switch to B (DELAYED SWEEP).
9. Adjust the DELAY-TIME MULTIPLIER dial to move the pulse (or the rising portion) to some vertical reference line. Note the setting of the DELAY-TIME MULTIPLIER dial.
10. Turn the DELAY-TIME MULTIPLIER dial clockwise until the second pulse is positioned to this same point (if several pulses are displayed, return to the A INTEN DURING B position to locate the correct pulse). Again note the dial setting.
11. Subtract the first dial setting from the second and multiply by the delay time shown by the A TIME/DIV switch. This is the time interval between the pulses.
12. If the MIXED mode of operation is used, the same procedure can be used to accurately determine sweep time. However, because the first part of the display is at a slower speed set by the A TIME/DIV switch, it will not be necessary to switch display modes to insure location of the correct pulse. The B (DELAYED SWEEP) mode is considered the most accurate and therefore the recommended mode of making differential time measurements.

**Example.** Assume the first dial setting is 1.31 and the second dial setting is 8.81 with the A TIME/DIV switch set to  $0.2 \mu\text{s}$  (see Fig. 2-24).

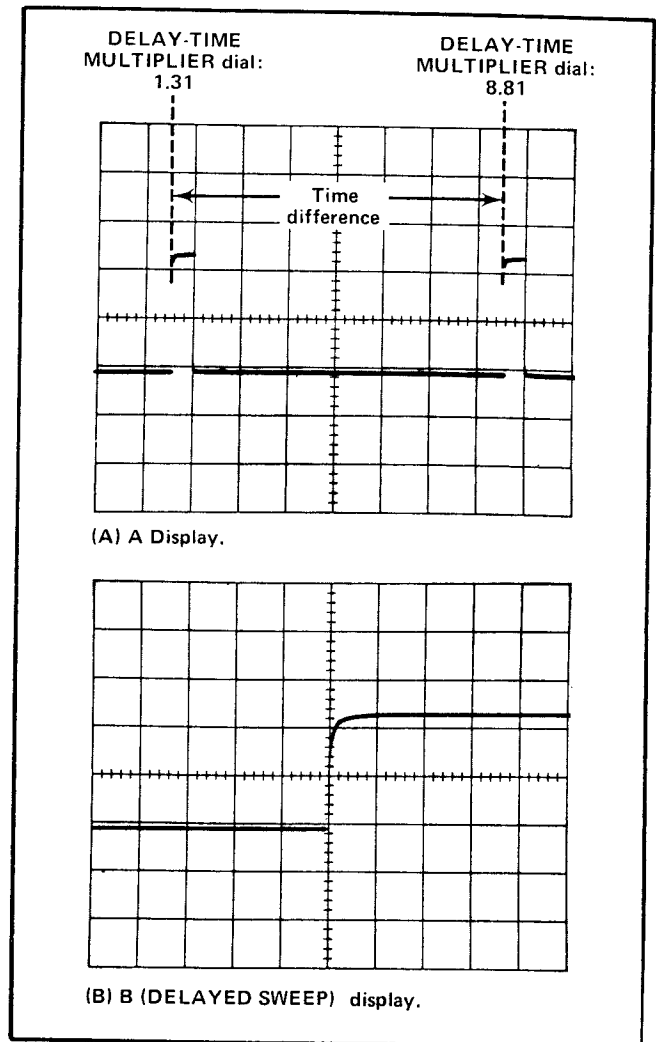

Fig. 2-24. Measuring time difference using delayed sweep.

Using the formula:

Time Difference  
(delayed sweep) =

$$\left[ \begin{array}{c} \text{second dial} \\ \text{setting} \end{array} - \begin{array}{c} \text{first dial} \\ \text{setting} \end{array} \right] \times \begin{array}{c} \text{delay time} \\ \text{(A TIME/DIV} \\ \text{setting)} \end{array}$$

Substituting the given values:

$$\text{Time Difference} = (8.81 - 1.31) \times 0.2 \mu\text{s}$$

The time difference is 1.5 microseconds

### Delayed or Mixed Sweep Magnification

The delayed sweep features of the 454A can be used to provide higher apparent magnification than is provided by

the MAG switch. The sweep rate of the delayed sweep (B sweep) is not actually increased, the apparent magnification is the result of delaying the B sweep an amount of time selected by the A TIME/DIV switch and the DELAY-TIME MULTIPLIER dial before the display is presented at the sweep rate selected by the B TIME/DIV switch. The following method uses the B STARTS AFTER DELAY TIME position to allow the delayed portion to be positioned with the DELAY-TIME MULTIPLIER dial. If there is too much jitter in the delayed display, use the TRIGGERABLE AFTER DELAY TIME mode of operation.

1. Connect the signal to either INPUT connector. Set the MODE switch to display the channel used.
2. Set the VOLTS/DIV switch to produce a display about four divisions in amplitude.
3. Set the A TIME/DIV switch to a sweep rate which displays the complete waveform.
4. Adjust the A Triggering controls for a stable display.
5. Set the HORIZ DISPLAY switch to A INTEN DURING B and the B SWEEP MODE switch to B STARTS AFTER DELAY TIME.
6. Position the start of the intensified portion with the DELAY-TIME MULTIPLIER dial to the part of the display to be magnified.
7. Set the B TIME/DIV switch to a setting which intensifies the full portion to be magnified. The start of the intensified trace remains as positioned above.
8. Set the HORIZ DISPLAY switch to B (DELAYED SWEEP).
9. Time measurements can be made from the display in the conventional manner. Sweep rate is determined by the setting of the B TIME/DIV switch.
10. Set the HORIZ DISPLAY switch to MIXED.
11. Time measurements can be made from the display in the conventional manner. Sweep rates of the first part of the display is determined by the setting of the A TIME/DIV switch and the sweep rate of the latter part of the display is determined by the setting of the B TIME/DIV switch.

12. The apparent sweep magnification can be calculated by dividing the A TIME/DIV switch setting by the B TIME/DIV switch setting.

**Example.** The apparent magnification of the display shown in Fig. 2-25 with an A TIME/DIV switch setting of .1 ms and a B TIME/DIV switch setting of 1  $\mu$ s is:

$$\text{Apparent Magnification (Delayed Sweep)} = \frac{\text{A TIME/DIV setting}}{\text{B TIME/DIV setting}}$$

Substituting the given values:

$$\text{Apparent Magnification} = \frac{1 \times 10^{-4}}{1 \times 10^{-6}}$$

The apparent magnification is 100 times.

**Triggered Delay Sweep Magnification.** The delayed sweep magnification method just described may produce too much jitter at high apparent magnification ranges. The TRIGGERABLE AFTER DELAY TIME position of the B SWEEP MODE switch provides a more stable display since the delayed display is triggered at the same point each time.

1. Set up the display as given in steps 1 through 7 described above.
2. Set the B SWEEP MODE switch to TRIGGERABLE AFTER DELAY TIME.
3. Adjust the B LEVEL control so the intensified portion on the trace is stable. (If an intensified portion cannot be obtained, see step 4.)
4. Inability to intensify the desired portion indicates that the signal does not meet the triggering requirements. If the condition cannot be remedied with the B Triggering controls or by increasing the display amplitude (lower VOLTS/DIV setting), trigger B sweep externally.
5. When the correct portion is intensified, set the HORIZ DISPLAY switch to B (DELAYED or MIXED SWEEP). Slight readjustment of the B LEVEL control may be necessary for a stable display.
6. Measurement and magnification are as described above.

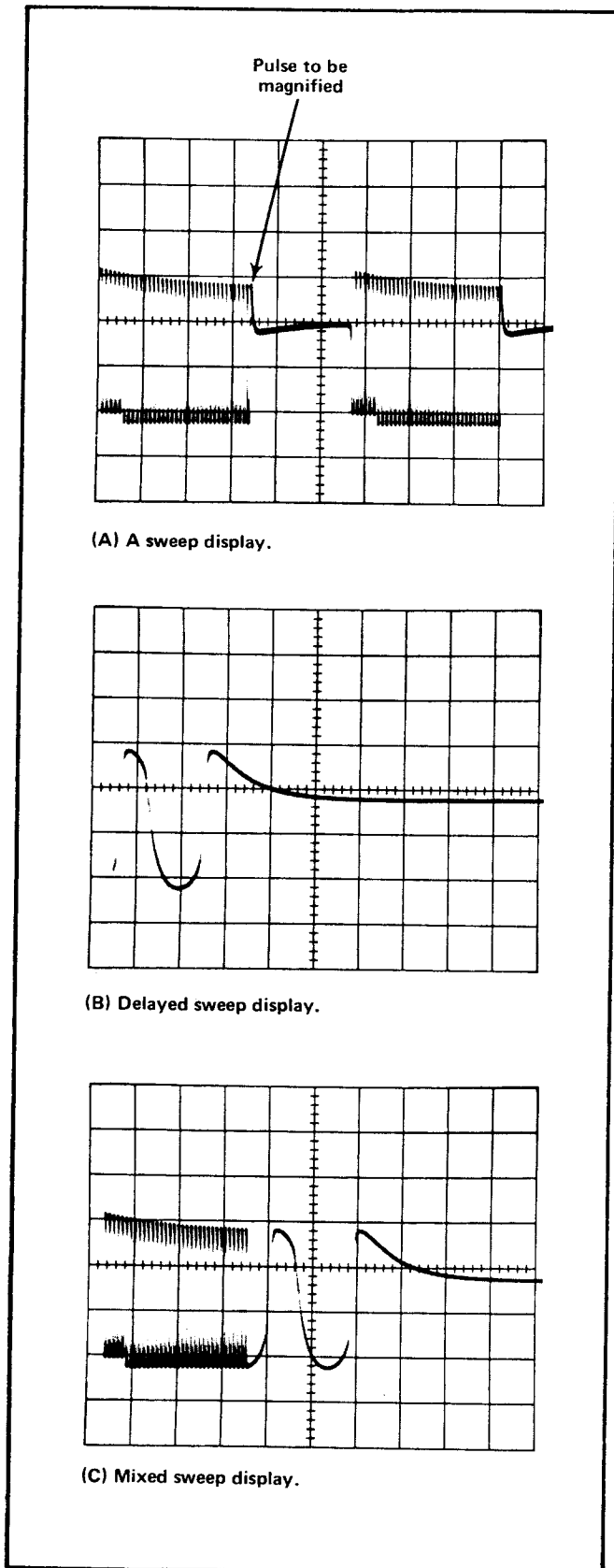

Fig. 2-25. Using delayed sweep for sweep magnification.

### Pulse Jitter Measurements

In some applications it is necessary to measure the amount of jitter on the leading edge of a pulse or jitter between pulses.

Use the following procedure:

1. Connect the signal to either INPUT connector. Set the MODE switch to display the channel used.
2. Set the VOLTS/DIV switch to display about four divisions of the waveform.
3. Set the A TIME/DIV switch to a sweep rate which displays the complete waveform.
4. Set the A Triggering controls to obtain as stable a display as possible.
5. Set the HORIZ DISPLAY switch to A INTEN DURING B and the B SWEEP MODE switch to B STARTS AFTER DELAY TIME.
6. Position the start of the intensified portion with the DELAY-TIME MULTIPLIER dial so the pulse to be measured is intensified.
7. Set the B TIME/DIV switch to a setting that intensifies the full portion of the pulse which shows jitter.
8. Set the HORIZ DISPLAY switch to B (DELAYED SWEEP).
9. Pulse jitter is shown by horizontal movement of the pulse (take into account inherent jitter of Delayed Sweep). Measure the amount of horizontal movement. Be sure both VARIABLE controls are set to CAL.
10. Multiply the distance measured in step 11 by the B TIME/DIV switch setting to obtain pulse jitter in time.

For Service Manuals Contact  
 MAURITRON TECHNICAL SERVICES  
 8 Cherry Tree, 1st. Chinnor  
 Oxon OX9 3QY  
 Tel: 01244-831111 Fax: 01244-352554  
 Email: enquiries@mairitron.co.uk



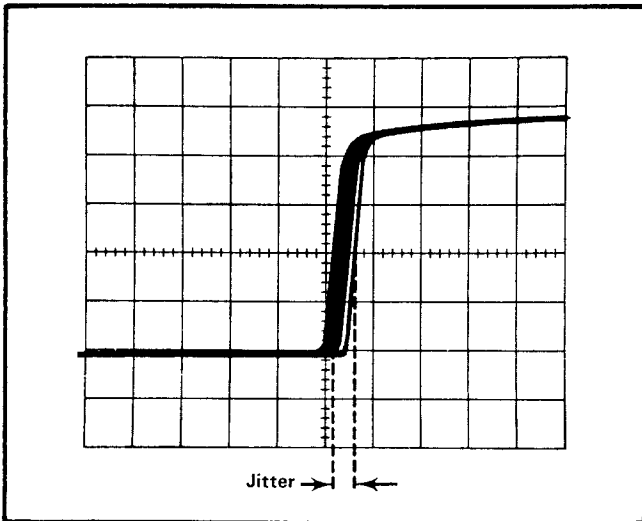

Fig. 2-26. Measuring pulse jitter.

**Example.** Assume that the horizontal movement is 0.5 division (see Fig. 2-26), and the B TIME/DIV switch setting is 0.5  $\mu$ s.

Using the formula:

$$\text{Pulse Jitter} = \frac{\text{horizontal jitter (divisions)}}{\text{B TIME/DIV setting}} \times \text{B TIME/DIV setting}$$

Substituting the given values:

$$\text{Pulse Jitter} = 0.5 \times 0.5 \mu\text{s}$$

The pulse jitter is 0.25 microsecond.

### Delayed Trigger Generator

The B + GATE output signal can be used to trigger an external device at a selected delay time after the start of A Sweep. The delay time of the B + GATE output signal can be selected by the setting of the DELAY-TIME MULTIPLIER dial and A TIME/DIV switch.

**A Sweep Triggered Internally.** When A sweep is triggered internally to produce a normal display, the delayed trigger may be obtained as follows:

1. Obtain a trigger display in the normal manner.
2. Set the HORIZ DISPLAY switch to A INTEN DURING B.

3. Select the amount of delay from the start of A Sweep with the DELAY-TIME MULTIPLIER dial. Delay time can be calculated in the normal manner.

4. Set the B SWEEP MODE switch to B STARTS AFTER DELAY TIME.

5. Connect the B + GATE signal to the external equipment.

6. The duration of the B + GATE signal is determined by the setting of the B TIME/DIV switch.

7. The external equipment will be triggered at the start of the intensified portion if it responds to positive-going triggers, or at the end of the intensified portion if it responds to negative-going triggers.

**A Sweep Triggered Externally.** This mode of operation can be used to produce a delayed trigger with or without a corresponding display. Connect the external trigger signal to the A EXT TRIG INPUT connector and set the A SOURCE switch to EXT. Follow the operation given above to obtain the delayed trigger.

### Normal Trigger Generator

Ordinarily, the signal to be displayed also provides the trigger signal for the oscilloscope. In some instances, it may be desirable to reverse this situation and have the oscilloscope trigger the signal source. This can be done by connecting the A + GATE signal to the input of the signal source. Set the A LEVEL control fully clockwise, A SWEEP MODE switch to AUTO TRIG and adjust the A TIME/DIV switch for the desired display. Since the signal source is triggered by a signal that has a fixed time relationship to the sweep, the output of the signal source can be displayed on the CRT as though the 454A were triggered in the normal manner.

### Multi-Trace Phase Difference Measurements

Phase comparison between two signals of the same frequency can be made using the dual-trace feature of the 454A. This method of phase difference measurement can be used up to the frequency limit of the vertical system. To make the comparison, use the following procedure:

1. Set the Input Coupling switches to the same position, depending on the type of coupling desired.
2. Set the MODE switch to either CHOP or ALT. In general, CHOP is more suitable for low-frequency signals

## Operating Instructions—454A/R454A

and the ALT position is more suitable for high-frequency signals. More information on determining the mode is given under Dual-Trace Operation in this section.

3. Set the TRIGGER switch to CH 1 ONLY.
4. Connect the reference signal to the INPUT CH 1 connector and the comparison signal to the INPUT CH 2 connector. The reference signal should precede the comparison signal in time. Use coaxial cables or probes which have equal time delay to connect the signals to the INPUT connectors.
5. If the signals are of opposite polarity, pull the INVERT switch out to invert the Channel 2 display. (Signals may be of opposite polarity due to 180° phase difference; if so, take this into account in the final calculation.)
6. Set the CH 1 and CH 2 VOLTS/DIV switches and the CH 1 and CH 2 VARIABLE controls so the displays are equal and about five divisions in amplitude.
7. Set the A Triggering controls to obtain a stable display.
8. Set the A TIME/DIV switch to a sweep rate which displays about one cycle of the waveform.
9. Move the waveforms to the center of the graticule with the CH 1 and CH 2 POSITION controls.
10. Turn the A VARIABLE control until one cycle of the reference signal (Channel 1) occupies exactly eight divisions between the first and ninth graticule lines (see Fig. 2-27). Each division of the graticule represents 45° of the cycle ( $360^\circ \div 8 \text{ divisions} = 45^\circ/\text{division}$ ). The sweep rate can be stated in terms of degrees as 45°/division.
11. Measure the horizontal difference between corresponding points on the waveforms.
12. Multiply the measured distance (in divisions) by 45°/division (sweep rate) to obtain the exact amount of phase difference.

**Example.** Assume a horizontal difference of 0.6 division with a sweep rate of 45°/division as shown in Fig. 2-27.

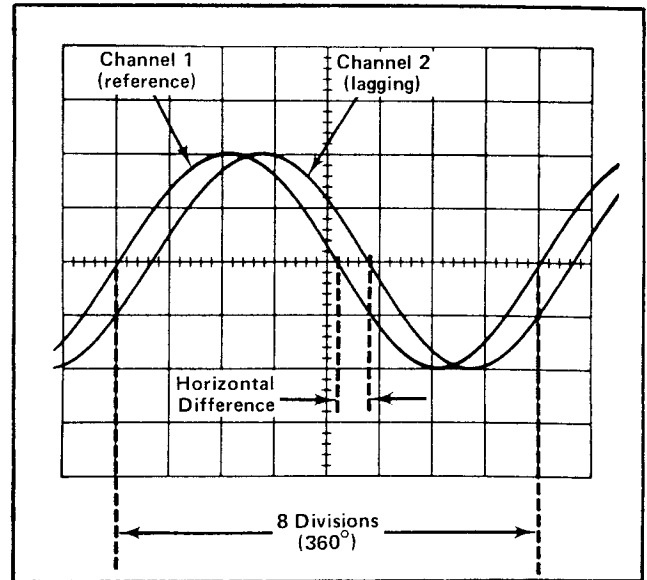

Fig. 2-27. Measuring phase difference.

For Service Manuals Contact  
**MAURITRON TECHNICAL SERVICES**  
 8 Cherry Tree Rd, Chinnor  
 Oxon OX9 4QY  
 Tel: 01844-351634 Fax: 01844-352554  
 Email: enquiries@mauritron.co.uk

Using the formula:

$$\text{Phase Difference} = \frac{\text{horizontal difference (divisions)}}{\text{sweep rate (degrees/div)}} \times$$

Substituting the given values:

$$\text{Phase Difference} = 0.6 \times 45^\circ$$

The phase difference is 27°.

## High Resolution Phase Measurements

More accurate dual-trace phase measurements can be made by increasing the sweep rate (without changing the A VARIABLE control setting). One of the easiest ways to increase the sweep rate is with the MAG switch. Delayed sweep magnification may also be used. The magnified sweep rate is determined by dividing the sweep rate obtained previously by the amount of sweep magnification.

**Example.** If the sweep rate were increased 10 times with the magnifier, the magnified sweep rate would be  $45^\circ \div 10 = 4.5^\circ/\text{division}$ . Fig. 2-28 shows the same signals as used in Fig. 2-27 but with the MAG switch set to X10. With a horizontal difference of 6 divisions, the phase difference is:

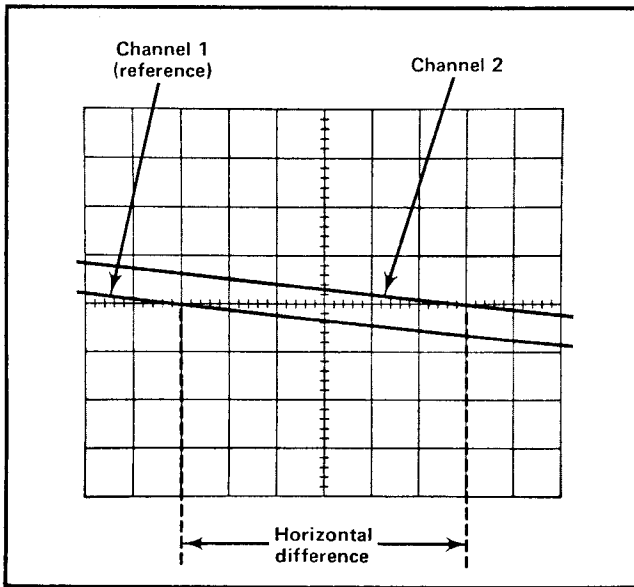

Fig. 2-28. High resolution phase-difference measurement with increased sweep rate.

$$\text{Phase Difference} = \frac{\text{horizontal difference (divisions)}}{\text{magnified sweep rate (degrees/div)}}$$

Substituting the given values:

$$\text{Phase Difference} = 6 \times 4.5^\circ$$

The phase difference is  $27^\circ$ .

### X-Y Phase Measurement

The X-Y phase measurement method can be used to measure the phase difference between two signals of the same frequency. This method provides an alternate method of measurement for signal frequencies up to two megahertz. However, above this frequency the inherent phase difference between the vertical and horizontal system makes accurate phase measurement difficult. In this mode, one of the sinewave signals provides horizontal deflection (X) while the other signal provides the vertical deflection (Y). The phase angle between the two signals can be determined from the lissajous pattern as follows:

1. Connect one of the sine-wave signals to the INPUT CH 1 or X connector and the other signal to the INPUT CH 2 or Y connector.

2. Set the HORIZ DISPLAY switch to X-Y, MAG switch to OFF and the TRIGGER switch to CH 1 ONLY or X-Y.

3. Position the display to the center of the screen and adjust the CH 1 and CH 2 VOLTS/DIV switches to produce

a display less than six divisions vertically (Y) and less than 10 divisions horizontally (X). The CH 1 VOLTS/DIV switch controls the horizontal deflection (X) and the CH 2 VOLTS/DIV switch controls the vertical deflection (Y).

4. Center the display in relation to the center graticule lines. Measure the distance A and B as shown in Fig. 2-29. Distance A is the horizontal measurement between the two points where the trace crosses the center horizontal line. Distance B is the maximum horizontal width of the display.

5. Divide A by B to obtain the sine of the phase angle ( $\Phi$ ) between the two signals. The angle can then be obtained from a trigonometric table.

6. If the display appears as a diagonal straight line, the two signals are either in phase (tilted upper right to lower left) or  $180^\circ$  out of phase (tilted upper left to lower right). If the display is a circle, the signals are  $90^\circ$  out of phase.

**Example.** To measure the phase of the display shown in Fig. 2-29 where A is 5 divisions and B is 10 divisions, use the formula:

$$\text{Sine } \Phi = \frac{A}{B}$$

Substituting the given values:

$$\text{Sine } \Phi = \frac{5}{10} = 0.5$$

From the trigonometric tables:

$$\Phi = 30^\circ$$

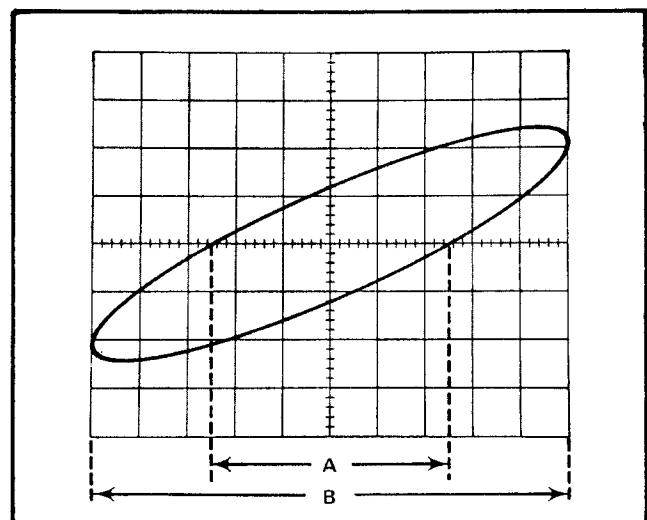

Fig. 2-29. Phase-difference measurement from an X-Y display.

### Common-Mode Rejection

The ADD feature of the 454A can be used to display signals which contain undesirable components. These undesirable components can be eliminated through common-mode rejection. The precautions given under Algebraic Addition should be observed.

1. Connect the signal containing both the desired and undesired information to the INPUT CH 1 connector.
2. Connect a signal similar to the unwanted portion of the Channel 1 signal to the INPUT CH 2 connector.
3. Set both Input Coupling switches to DC (AC if DC component of input signal is too large).
4. Set the MODE switch to ALT. Set the VOLTS/DIV switches so the signals are about equal in amplitude.

5. Set the TRIGGER switch to NORM.

6. Set the MODE switch to ADD. Pull the INVERT switch so the common-mode signals are of opposite polarity.

7. Adjust the CH 2 VOLTS/DIV switch and CH 2 VARIABLE control for maximum cancellation of the common-mode signal.

8. The signal which remains should be only the desired portion of the Channel 1 signal. The undesired signal is cancelled out.

**Example.** An example of this mode of operation is shown in Fig. 2-30. The signal applied to Channel 1 contains unwanted line-frequency components (see Fig. 2-30A). A corresponding line-frequency signal is connected to Channel 2 (see Fig. 2-30B). Fig. 2-30C shows the desired portion of the signal as displayed when common-mode rejection is used.

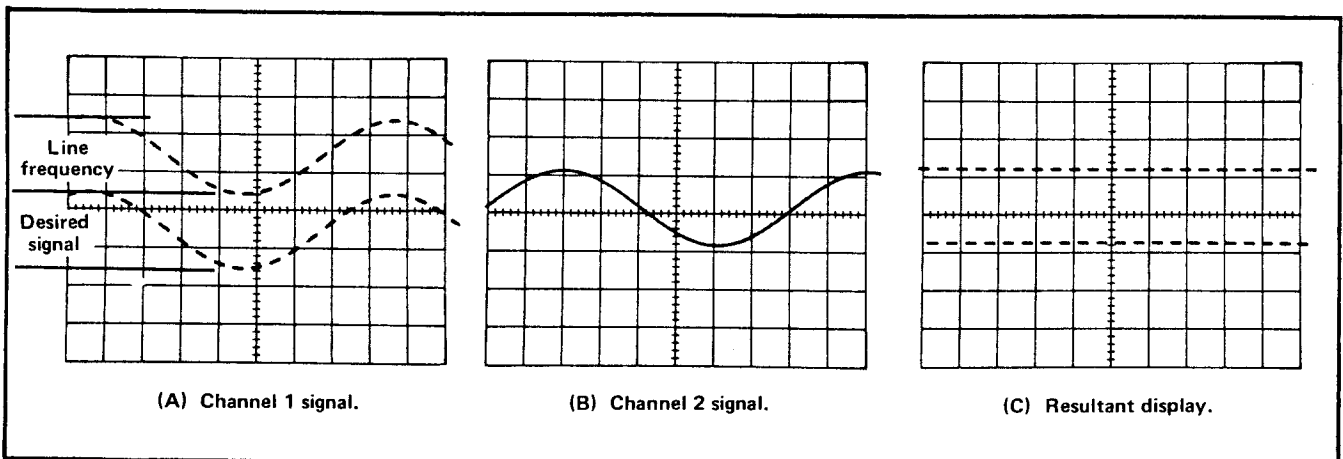

Fig. 2-30. Using the ADD feature for common-mode rejection. (A) Channel 1 signal contains desired information along with line-frequency component. (B) Channel 2 signal contains line-frequency only, (C) CRT display using common-mode rejection.

For Service Manuals Contact  
MAURITRON TECHNICAL SERVICES  
8 Cherry Tree Rd, Chinnor  
Oxon OX9 4QY  
Tel: 01844 351004 Fax: 01844-352554  
Email: enquiries@mauritron.co.uk

# SECTION 3

## CIRCUIT DESCRIPTION

*Change information, if any, affecting this section will be found at the rear of this manual.*

### Introduction

This section of the manual contains a description of the circuitry used in the 454A Oscilloscope. The description begins with a discussion of the instrument using the basic block diagram shown in Fig. 3-1. Then each circuit is described in detail using a detailed block diagram to show the interconnections between the stages in each major circuit and the relationship of the front-panel controls to the individual stages.

A complete block diagram is located in the Diagrams section at the rear of this manual. This block diagram shows the overall relationship between all of the circuits in this instrument. Complete schematics of each circuit are also given in the Diagrams section. Refer to these diagrams throughout the following circuit description for electrical values and relationships.

### BLOCK DIAGRAM

#### General

The following discussion is provided to aid in understanding the overall concept of the 454A before the individual circuits are discussed in detail. A basic block diagram of the 454A is shown in Fig. 3-1. Only the basic interconnections between the individual blocks are shown on this diagram. Each block represents a major circuit within the instrument. The number on each block refers to the complete circuit diagram which is located at the rear of this manual.

Signals to be displayed on the CRT are applied to either the INPUT CH 1 OR X and/or the INPUT CH 2 OR Y connector. The input signals are then amplified by the Channel 1 Vertical Preamp and/or the Channel 2 Vertical Preamp circuits. Each Vertical Preamp circuit also includes separate vertical deflection factor, position, input coupling, gain, variable attenuation and balance controls. A trigger-pickoff stage in the Channel 1 Vertical Preamp circuit supplies a sample of the Channel 1 signal to the Trigger Preamp circuit or the CH 1 OUT connector. The Channel 2 Vertical Preamp contains an invert feature that permits inversion of the Channel 2 display on the CRT. The output of both Vertical Preamp circuits is connected to the Vertical Switching circuit. This circuit selects the channel(s) to be displayed. An output signal from this circuit is connected

to the Z Axis Amplifier circuit to blank out the between-channel switching transients when in the chopped mode of operation. A trigger-pickoff network at the output of the Vertical Switching circuit provides a sample of the displayed signal(s) to the Trigger Preamp circuit.

The output of the Vertical Switching circuit is connected to the Vertical Output Amplifier through the Delay-Line Driver stage and the Delay Line. The Vertical Output Amplifier circuit provides the final amplification for the signal before it is applied to the vertical deflection plates of the CRT. This circuit includes the BANDWIDTH-BEAM FINDER switch which limits the vertical bandwidth to about 20 megahertz in the up position, and provides full bandwidth in the FULL position. When pressed down, the vertical deflection (along with the horizontal) is compressed within the viewing area to aid in locating an overscanned or off-screen display.

The Trigger Preamp circuit provides amplification for the internal trigger signal selected by the TRIGGER switch. This internal trigger signal is selected from either the Channel 1 Vertical Preamp circuit or the Vertical Switching circuit. Output from this circuit is connected to the A Trigger Generator circuit, B Trigger Generator circuit and the Horizontal Amplifier circuit (for X-Y mode operation).

The A and B Trigger Generator circuits produce an output pulse which initiates the sweep signal produced by the A or B Sweep Generator circuits. The input signal to the A and B Trigger Generator circuits can be individually selected from the internal trigger signal from the Trigger Preamp circuit, an external signal applied to the EXT TRIG INPUT connector, or a sample of the line voltage applied to the instrument. Each trigger circuit contains level, slope, coupling and source controls.

The A Sweep Generator circuit produces a linear sawtooth output signal when initiated by the A Trigger Generator circuit. The slope of the sawtooth produced by the A Sweep Generator circuit is controlled by the A TIME/DIV switch. The operating mode of the A Sweep Generator circuit is controlled by the A SWEEP MODE switch. In the AUTO TRIG position, the absence of an adequate trigger signal causes the sweep to free run. In the NORM TRIG position, a horizontal sweep is presented only when cor-

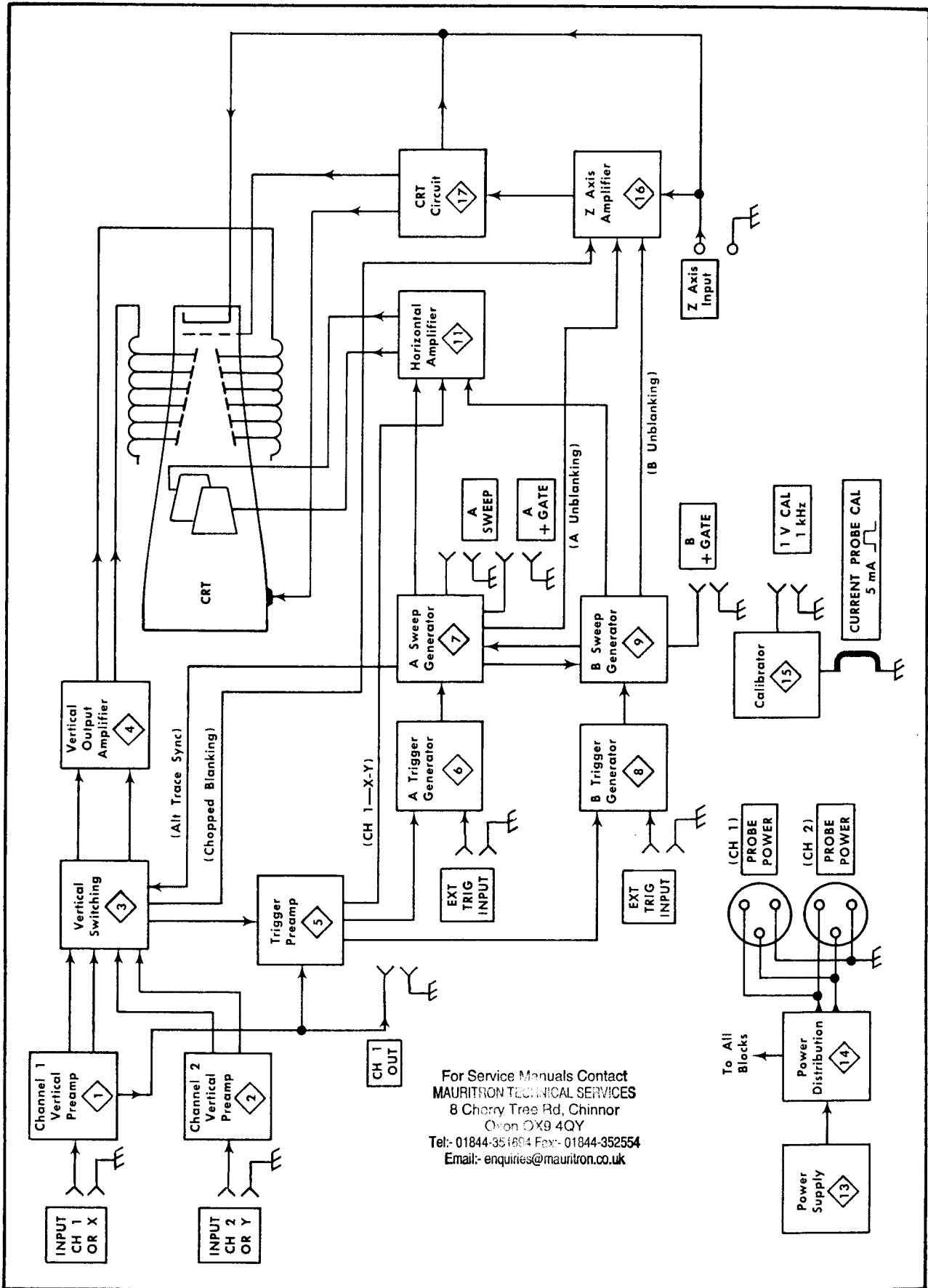

For Service Manuals Contact  
**MAURITRON TECHNICAL SERVICES**  
 8 Cherry Tree Rd, Chinnor  
 Oxon OX9 4QY  
 Tel:- 01844-351694 Fax:- 01844-352554  
 Email:- enquiries@mauritron.co.uk

Fig. 3-1. Basic block diagram of the 454A.

rectly triggered by an adequate trigger signal. The SINGLE SWEEP position allows one (and only one) sweep to be initiated after the circuit is reset with the RESET button. The A Sweep Generator circuit also produces an unblanking gate signal coincident with the sawtooth waveform produced by the A Sweep Generator circuit. This gate signal unblanks the CRT to permit display presentation. Another gate signal also coincident with the A Sweep Generator sawtooth is available at the A GATE connector on the instrument side panel. An alternate sync pulse produced in the A Sweep Generator is connected to the Vertical Switching circuit. This pulse switches the display between channels at the end of each sweep when the MODE switch is in the ALT position.

The B Sweep Generator circuit is basically the same as the A Sweep Generator circuit. However, this circuit only produces a sawtooth output signal after a delay time determined by the A TIME/DIV switch and the DELAY-TIME MULTIPLIER dial. If the B SWEEP MODE switch is set to the B STARTS AFTER DELAY TIME position, the B Sweep Generator begins to produce the sweep immediately following the selected delay time. If this switch is in the TRIGGERABLE AFTER DELAY TIME position, the B Sweep Generator circuit does not produce a sweep until it receives a trigger pulse from the B Trigger Generator circuit after the selected delay time.

In the MIXED position of the HORIZ DISPLAY switch, the output signal from the B Sweep Generator is a composite sawtooth waveform with the slope of the first part of the waveform determined by the A Sweep Generator, and the slope of the second part of the waveform determined by the B Sweep Generator.

The output of either the A or B Sweep Generator circuit is amplified by the Horizontal Amplifier circuit to produce horizontal deflection for the CRT in all positions of the HORIZ DISPLAY switch except X-Y. The Horizontal Amplifier contains a X10 magnifier to increase the sweep rate ten times in any TIME/DIV switch position. Other horizontal deflection signals can be connected to the Horizontal Amplifier by using the X-Y mode of operation. The X signal is connected to the Horizontal Amplifier circuit through the Channel 1 Vertical Preamp circuit and the Trigger Preamp circuit, when the HORIZ DISPLAY switch is set to X-Y and the TRIGGER switch is set to CH 1 ONLY OR X-Y.

The Z Axis Amplifier circuit determines the CRT intensity and blanking. The Z-Axis Amplifier circuit sums the current inputs from the INTENSITY control, Vertical Switching circuit (chopped blanking), A and B Sweep Generator circuit (unblanking) and the external Z AXIS INPUT binding post. The output level of the Z Axis Amplifier circuit controls the trace intensity through the CRT

Circuit. The CRT Circuit provides the voltages and contains the controls necessary for operation of the cathode-ray tube.

The Power Supply circuit provides the low-voltage power necessary for operation of this instrument. This voltage is distributed to all of the circuits in the instrument as shown by the Power Distribution circuit. This circuit also provides the voltage levels to the PROBE POWER connectors for the operation of active probe systems. The Calibrator circuit produces a square-wave output with accurate amplitude and frequency which can be used to check the calibration of this instrument and the compensation of probes. The CURRENT PROBE CAL loop provides an accurate current source for calibration of current-measuring probe systems.

## CIRCUIT OPERATION

### General

This section provides a detailed description of the electrical operation and relationship of the circuits in the 454A. The theory of operation for circuits unique to this instrument is described in detail in this discussion. Circuits which are commonly used in the electronics industry are not described in detail. If more information is desired on these commonly used circuits, refer to the following textbooks:

Tektronix Circuit Concepts Books (order from your local Tektronix Field Office or representative).

Cathode-Ray Tubes, Tektronix Part No. 062-0852-01.

Oscilloscope Trigger Circuits, Tektronix Part No. 062-1056-00.

Power Supply Circuits, Tektronix Part No. 062-0888-01.

Sweep Generator Circuits, Tektronix Part No. 062-1098-01.

Oscilloscope Probe Circuits, Tektronix Part No. 062-1146-00.

Vertical Amplifier Circuits, Tektronix Part No. 062-1145-00.

Horizontal Amplifier Circuits, Tektronix Part No. 062-1144-00.

Phillip Cutler, "Semiconductor Circuit Analysis", McGraw-Hill, New York, 1964.

Lloyd P. Hunter (Ed.), "Handbook of Semiconductor Electronics", second edition, McGraw-Hill, New York, 1962.

Jacob Millman and Herbert Taub, "Pulse, Digital, and Switching Waveforms", McGraw-Hill, New York, 1965.

The following circuit analysis is written around the detailed block diagrams which are given for each major circuit. These detailed block diagrams give the names of the individual stages within the major circuits and show how they are connected together to form the major circuit. The block diagrams also show the inputs and outputs for each circuit and the relationship of the front-panel controls to the individual stages. The circuit diagrams from which the detailed block diagrams are derived are shown in the Diagrams section.

### CHANNEL 1 VERTICAL PREAMP

#### General

Input signals for vertical deflection on the CRT can be connected to the INPUT CH 1 OR X connector. In the X-Y mode of operation, this input signal provides the horizontal (X-axis) deflection. The Channel 1 Vertical Preamp circuit provides control of input coupling, vertical deflection factor, balance, vertical position and vertical gain. It also contains a stage to provide a sample of the Channel 1 input signal to the Trigger Preamp circuit for internal triggering from the Channel 1 signal only. Fig. 3-2 shows a detailed block diagram of the Channel 1 Vertical Preamp circuit. A schematic of this circuit is shown on diagram 1 at the back of this manual.

#### Input Coupling

Input signals connected to the INPUT CH 1 OR X connector can be AC-coupled, DC-coupled or internally disconnected. When the Input Coupling switch, S1, is in the DC position, the input signal is coupled directly to the Input Attenuator stage. In the AC position, the input signal passes through capacitor C1. This capacitor prevents the DC component of the signal from passing to the amplifier. The GND position opens the signal path and connects the input circuit of the amplifier to ground. This provides a ground reference without the need to disconnect the applied signal from the INPUT connector. Resistor R3, connected across the Input Coupling switch, allows C1 to be precharged in the GND position so the trace remains on screen when switching to the AC position if the applied signal has a high DC level. C2-R2 reduce the very fast step response overshoot in the AC position of the Input Coupling switch. C4-R4 provides damping for the attenuator.

#### Input Attenuator

The  $\div 10$  and  $\div 100$  Input Attenuators are frequency compensated voltage dividers. For DC and low-frequency signals, they are primarily resistance dividers and the voltage attenuation is determined by the resistance ratio in the

attenuator. The reactance of the capacitors in the circuit is so high at low frequencies that their effect is negligible. However, at higher frequencies, the reactance of the capacitors decreases and the attenuator becomes primarily a capacitance voltage divider. Each attenuator contains an adjustable series capacitor to provide optimum response for the high-frequency components of the signal and an adjustable shunt capacitor for optimum response for the lower-frequency components. In addition to providing constant attenuation at all frequencies within the bandwidth, Input Attenuators are designed to maintain the same input RC characteristics (one megohm X 15 pF) for each setting of the CH 1 VOLTS/DIV switch.

#### Input Amplifier

The Input Source Follower stage Q13A provides a high input impedance with a low impedance drive for the following stage. R8 and R9 in the gate circuit of Q13A establish the input resistance of this stage. These resistors are part of the attenuation network at all CH 1 VOLTS/DIV switch positions. Variable capacitor C9 adjusts the basic input time constant for a nominal value of one megohm X 15 pF. R10 limits the current drive to the gate of Q13A. Diode CR13 provides circuit protection by limiting the negative swing at the gate of Q13A to about  $-12.5$  volts.

Q13B provides a constant current source for Q13A. The STEP ATTEN BAL adjustment, R21, varies the gate level of Q13B to provide a zero-volt level at the emitter of Q34 with no signal applied. With a zero-volt level at the emitter of Q34, the position of a zero-volt reference trace will not change when switching between 2 mV/div and 10 mV/div positions of the CH 1 VOLTS/DIV switch.

Q16A is an emitter follower that provides isolation between the input circuitry and the attenuation switching that takes place in the emitter of Q16A. In the 20 mV, .2 V, and 2 V positions of the CH 1 VOLTS/DIV switch, a divide by 2 attenuator is switched in between the emitter of Q16A and the base of Q34. In the 50 mV, .5 V and 5 V positions of the CH 1 VOLTS/DIV switch a divide by 5 attenuator is switched in. Divide by 1 attenuation is provided in all other switch positions. The Int Atten Bal adjustment R28 varies the base level of Q16B to provide the same voltage levels at the emitters of Q16A and Q16B. This prevents the position of a zero-volt reference trace from changing when switching between attenuator switch positions above 20 mV/div. R16, C16 and C22 provide frequency compensation for this stage.

#### Feedback Amplifier

The Feedback Amplifier stage, Q34-Q38-Q44-Q45, changes the overall gain of the Channel 1 Vertical Preamp circuit to provide the correct deflection factor in the 2 mV



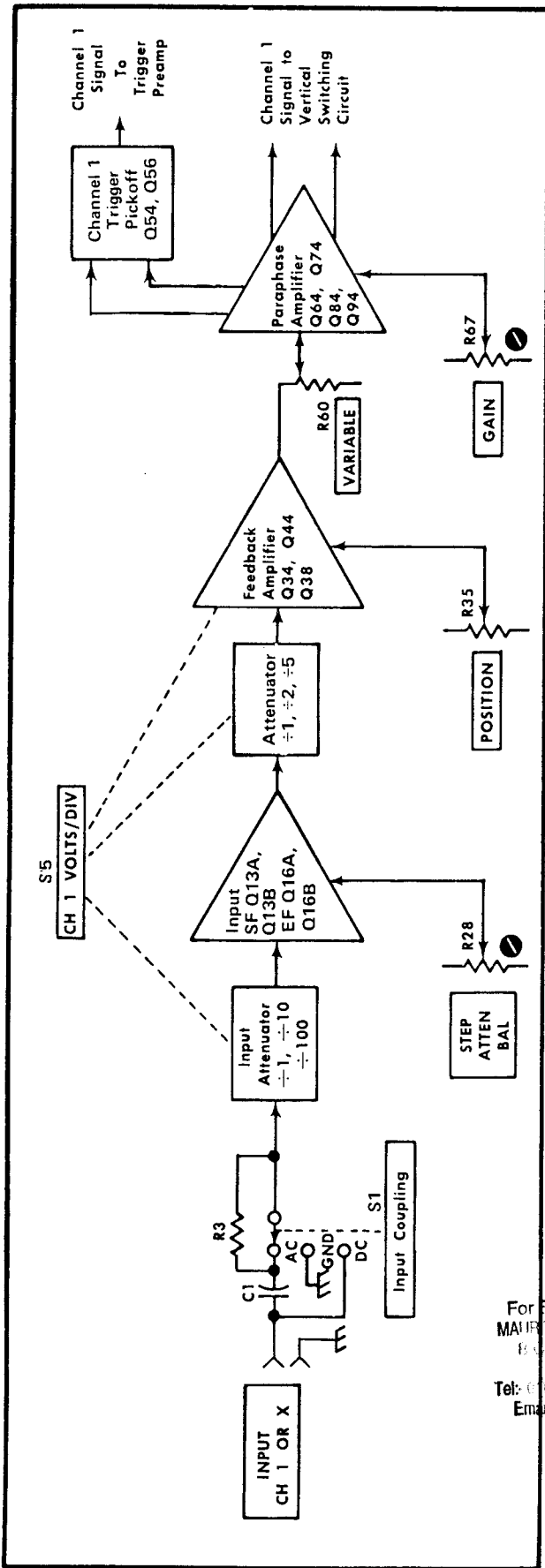

Fig. 3-2. Channel 1 Vertical Preamp detailed block diagram.

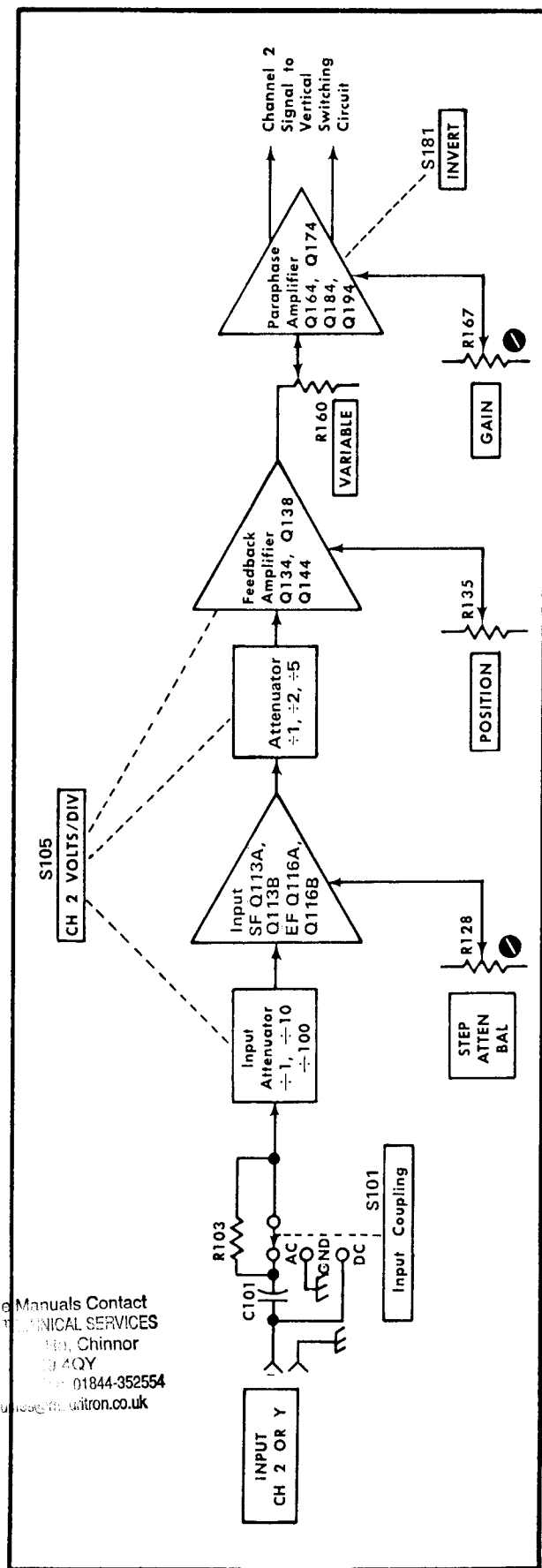

Fig. 3-3. Channel 2 Vertical Preamp detailed block diagram.

For Service Manuals Contact  
 MAINTENANCE TECHNICAL SERVICES  
 101, Chinnor  
 Bucks, HP8 4QY  
 Tel: 01844-352554  
 Email: enquiries@mitron.co.uk

## Circuit Description—454A/R454A

and 5 mV positions of the CH 1 VOLTS/DIV switch. Approximate gain of this stage is determined by the formula:

$$\text{Voltage Gain, } A = \frac{R42 + R47}{R42}$$

The value of feedback resistor R42 is changed to provide the correct gain by switching in resistances in parallel with R42.

Vertical position of the trace is determined by the setting of the POSITION control, R35. This control changes the base level of Q38, which changes the current drive to Q34. Since the emitter of Q34 is a very low-impedance point in the circuit, there is negligible voltage change at this point. However, the change in current from the POSITION control produces a resultant DC voltage at the output of the Feedback Amplifier stage to change the vertical position of the trace. The CH 1 Position Center adjustment, R40, is adjusted to provide a centered display when the CH 1 POSITION control is centered (with a zero-volt DC input level).

Transistor Q45 provides a low-impedance voltage source for the emitter of Q44. Variable resistor R44 provides emitter damping for Q44 to prevent high-frequency ringing, and C45 provides high-frequency peaking. Inductor L44 provides a constant DC bias for Q44 while R44 is being adjusted for correct high-frequency response. The output signal from the Feedback Amplifier stage is connected to the Paraphase Amplifier stage.

### Paraphase Amplifier

The output signal from the Feedback Amplifier stage is connected to the Paraphase Amplifier stage through the VARIABLE control, R60A-R60B. This control and the T-coil, L64, are designed to provide a constant load for Q44 when the VARIABLE control is rotated. When the VARIABLE control is set to the CAL position (fully clockwise), R60A is by-passed and R60B is set for maximum resistance. Maximum signal current reaches the base of Q64. Switch S60, ganged with the VARIABLE control, is closed and the UNCAL neon bulb is by-passed. As the VARIABLE control is rotated counterclockwise from the CAL detent, S60 opens and the UNCAL light, DS63, ignites to indicate that the vertical deflection factor is uncalibrated. The signal applied to the base of Q64 is continuously reduced by R60A as the VARIABLE control is rotated counterclockwise. At the same time that the resistance of R60A increases, the resistance of R60B decreases so the combined resistance of R60A, R60B and R62 remains the same to maintain a constant load for the Feedback Amplifier stage.

Q64 and Q74 are connected as a common-emitter phase inverter (paraphase amplifier) to convert the single-ended

input signal to a push-pull output signal. Gain of the stage is determined by the emitter degeneration. As the resistance between the emitters of Q64 and Q74 increases, emitter degeneration increases also to result in less gain through the stage. The GAIN adjustment, R67, varies the resistance between the emitters to control the overall gain of the Channel 1 Vertical Preamp circuit. Capacitor C78 is adjustable to vary the high-frequency gain of this stage to provide optimum high-frequency response.

Transistors Q84 and Q94 provide the output signal from the Channel 1 Vertical Preamp circuit. The signal at the collectors of Q64 and Q74 is connected to the emitters of the grounded-base stage, Q84 and Q94. The output signal on the collectors of Q84 and Q94 is connected to the Channel 1 Diode Gate stage in the Vertical Switching circuit. A sample of the Channel 1 signal is taken from the emitters of Q64 and Q74 and applied to the Channel 1 Trigger Pickoff stage.

### Channel 1 Trigger Pickoff

The Channel 1 Trigger Pickoff stage is an emitter coupled amplifier stage with the main signal drive applied to the base of Q56 and the output signal taken from the collector of Q54. This circuit configuration offers good frequency response and DC stability and reduces unwanted common-mode signals. The CH 1 Output DC Level adjustment, R52, adjusts the DC level at the CH 1 OUT connector for a zero-volt output level when the Channel 1 trace is centered vertically. Output from the Channel 1 Trigger Pickoff stage is connected to the Trigger Preamp circuit through the TRIGGER switch, S238B.

## CHANNEL 2 VERTICAL PREAMP

### General

The Channel 2 Vertical Preamp circuit is basically the same as the Channel 1 Vertical Preamp circuit. Only the differences between the two circuits are described here. Portions of this circuit not described in the following description operate in the same manner as for the Channel 1 Vertical Preamp circuit (corresponding circuit numbers assigned in the 100-199 range). Fig. 3-3 shows a detailed block diagram of the Channel 2 Vertical Preamp circuit. A schematic of this circuit is shown on diagram 2 at the rear of this manual.

### Paraphase Amplifier

The basic Channel 2 Paraphase Amplifier configuration and operation is the same as for Channel 1. However, the INVERT switch, S181, has been added in the Channel 2 circuit. This switch allows the output signal from the Paraphase Amplifier to be connected to either emitter of the

grounded-base output stage, Q184 and Q194. This action allows the displayed signal from Channel 2 to be inverted.

Also, the Channel 2 Vertical Preamp circuit does not have a trigger pickoff stage. To provide a load at the emitter of Q164 similar to the load that the Channel 1 Trigger Pickoff stage provides at the emitter of Q64, C180 and R180 are connected into the circuit.

## VERTICAL SWITCHING

### General

The Vertical Switching circuit determines whether the CH 1 and/or the CH 2 Vertical Preamp output signal is connected to the Vertical Output Amplifier circuit (through the Delay Line Driver and Delay Line stages). In the ALT and CHOP positions of the MODE switch, both channels are alternately displayed on a shared-time basis. Fig. 3-4 shows a detailed block diagram of the Vertical Switching circuit. A schematic of this circuit is shown on diagram 3 at the rear of this manual.

### Diode Gate

The Diode Gates, consisting of four diodes each, can be thought of as switches which allow either of the Vertical

Preamp output signals to be coupled to the Delay-Line Driver stage. CR201 through CR204 control the Channel 1 signal output and CR206 through CR209 control the Channel 2 signal output. These diodes are in turn controlled by the Switching Multivibrator stage for dual-trace displays, or by the MODE switch for single-trace displays.

**CH 1.** In the CH 1 position of the MODE switch,  $-12$  volts is applied to the junction of CR207-CR208 in the Channel 2 Diode Gate through the HORIZ DISPLAY switch S1001A, MODE switch S238A and R224 (see simplified diagram in Fig. 3-5). This forward biases CR207-CR208 and reverse biases CR206-CR209 since the input to the Delay-Line Driver stage is at about  $-3$  volts. CR206-CR209 block the Channel 2 signal so it cannot pass to the Delay-Line Driver stage. At the same time in the Channel 1 Diode Gate, CR202-CR203 are connected to ground through R210. CR202-CR203 are held reverse biased while CR201-CR204 are forward biased. Therefore, the Channel 1 signal can pass to the Delay-Line Driver stage.

**CH 2.** In the CH 2 position of the MODE switch, the above conditions are reversed. CR202-CR203 are connected to  $-12$  volts through S1001A, S238A and R214, and

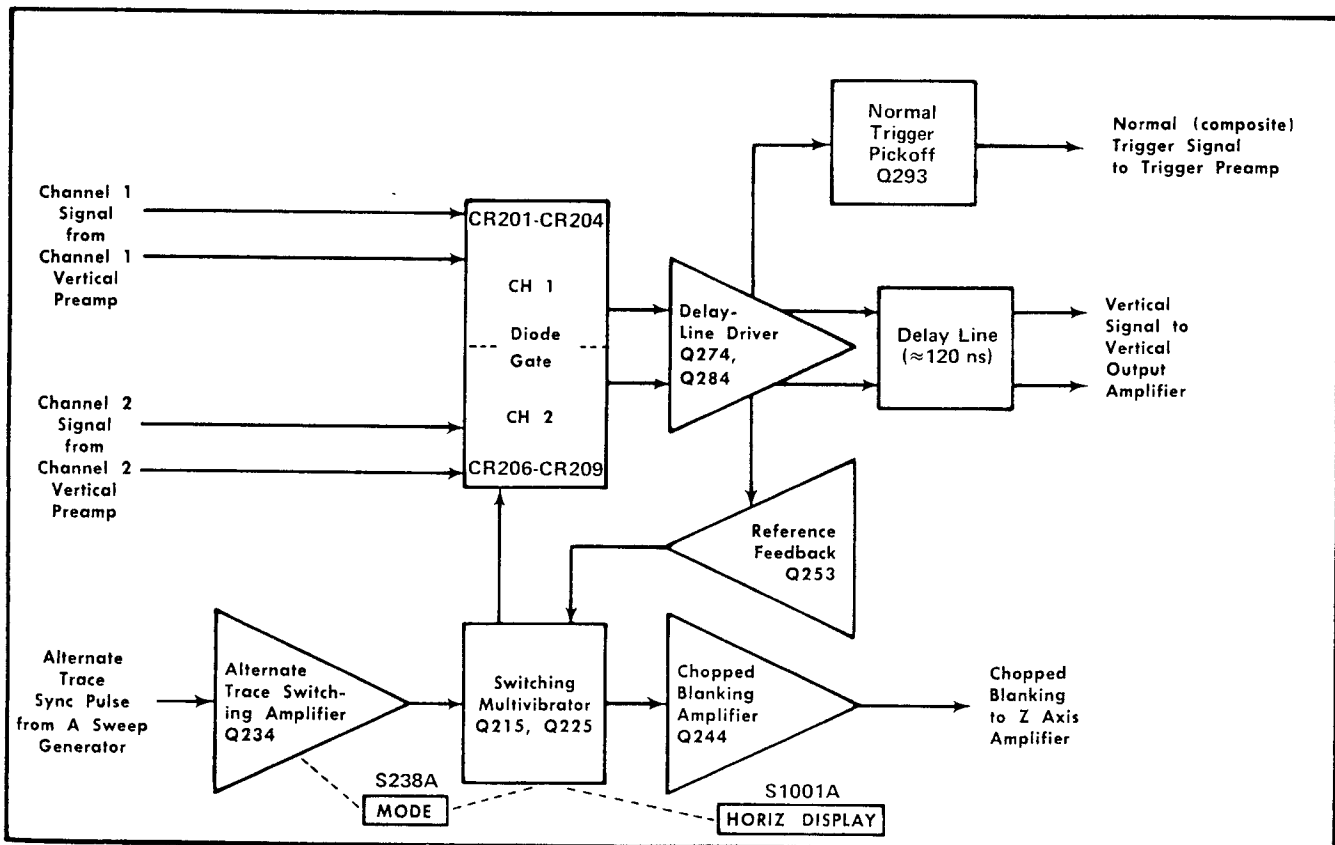

Fig. 3-4. Vertical Switching detailed block diagram.

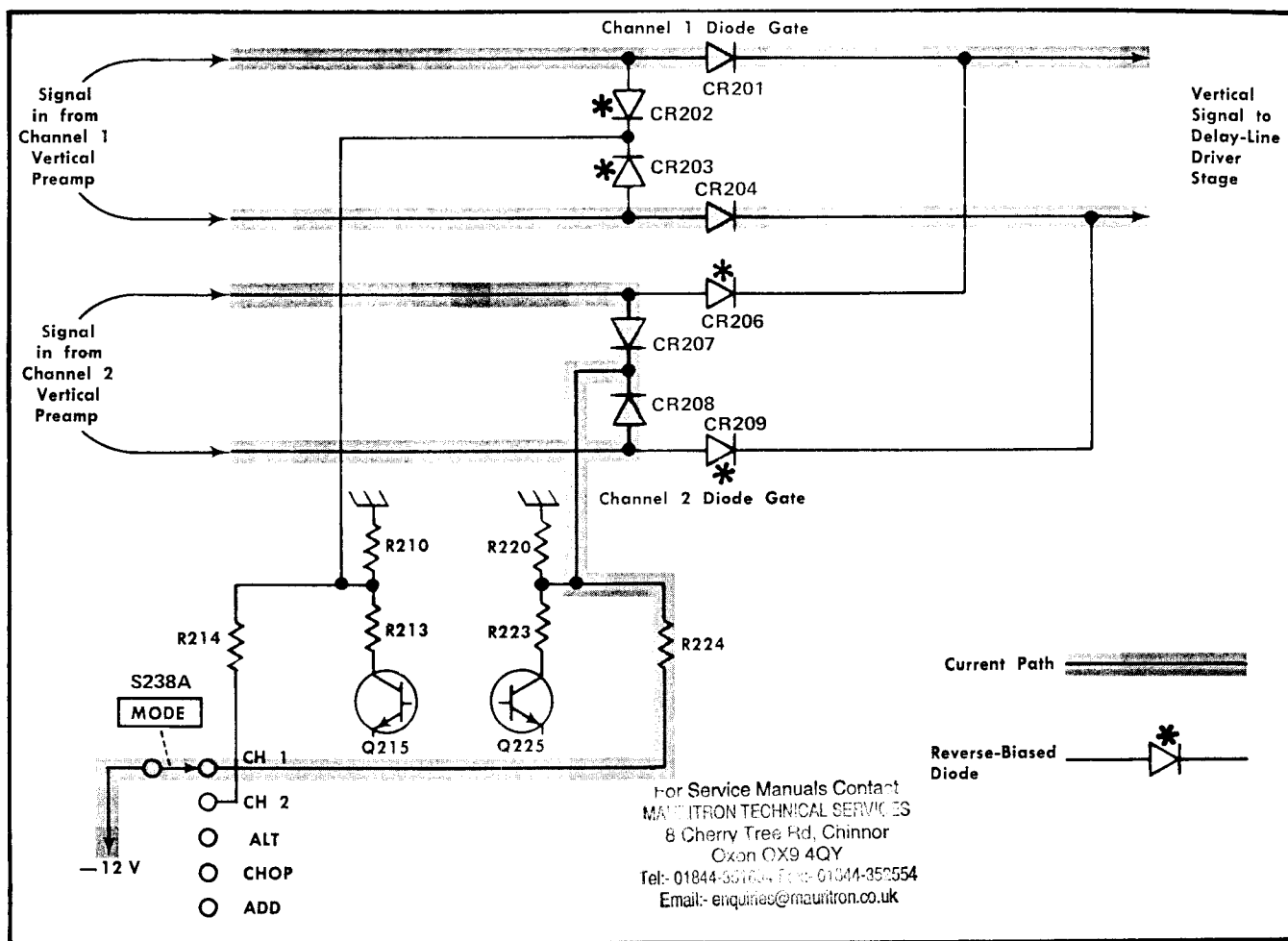

Fig. 3-5. Effect of Diode Gates on signal path (simplified path). Conditions shown for CH 1 position of the MODE switch.

CR207-CR208 are connected to ground through R220 (see simplified diagram in Fig. 3-6). The Channel 1 Diode Gate blocks the signal and the Channel 2 Diode Gate allows it to pass.

The HORIZ DISPLAY switch, S1001A, locks this circuit in the Channel 2 condition when operating in the X-Y mode. This provides -12 volts to reverse bias the Channel 1 Diode gate through R214 and allows the Channel 2 signal to pass to the Delay-Line Driver stage. The setting of the MODE switch has no effect on circuit operation in the X-Y mode (also see Horizontal Amplifier discussion).

**Switching Multivibrator**

ALT. In this mode of operation, the Switching Multivibrator operates as a bistable multivibrator. In the ALT position of the MODE switch, -12 volts is connected to the emitter of Q234, Alternate Trace Switching Amplifier stage, through S1001A and S238A. Q234 is forward biased to supply current to the "on" transistor in the Switching Multivibrator stage through R233, R234, CR234, and

CR218 or CR228. For example, if Q225 is conducting, current is supplied to Q225 through R229. The current flow through collector resistors R223 and R220 drops the CR207-CR208 cathode level negative so the Channel 2 Diode Gate is blocked as for Channel 1 only operation. The signal passes through the Channel 1 Diode Gate to the Delay-Line Driver stage.

The Alternate-trace sync pulse is applied to Q234 at the end of each sweep. This negative-going sync pulse momentarily interrupts the current through Q234 and both Q215 and Q225 are turned off. When Q234 turns on again after the alternate-trace sync pulse, the charge on C218 determines whether Q215 or Q225 conducts. For example, when Q225 was conducting, C218 was charged negatively on the CR218 side to the emitter level of Q215, and positively on the CR228 side. This charge is stored while Q234 is off and holds the emitter of Q215 more negative than the emitter of Q225. When both Q215 and Q225 were off the voltage at their bases became approximately equal. Now when Q234 comes back on, the transistor with the most negative emitter will start conducting first with the resulting negative

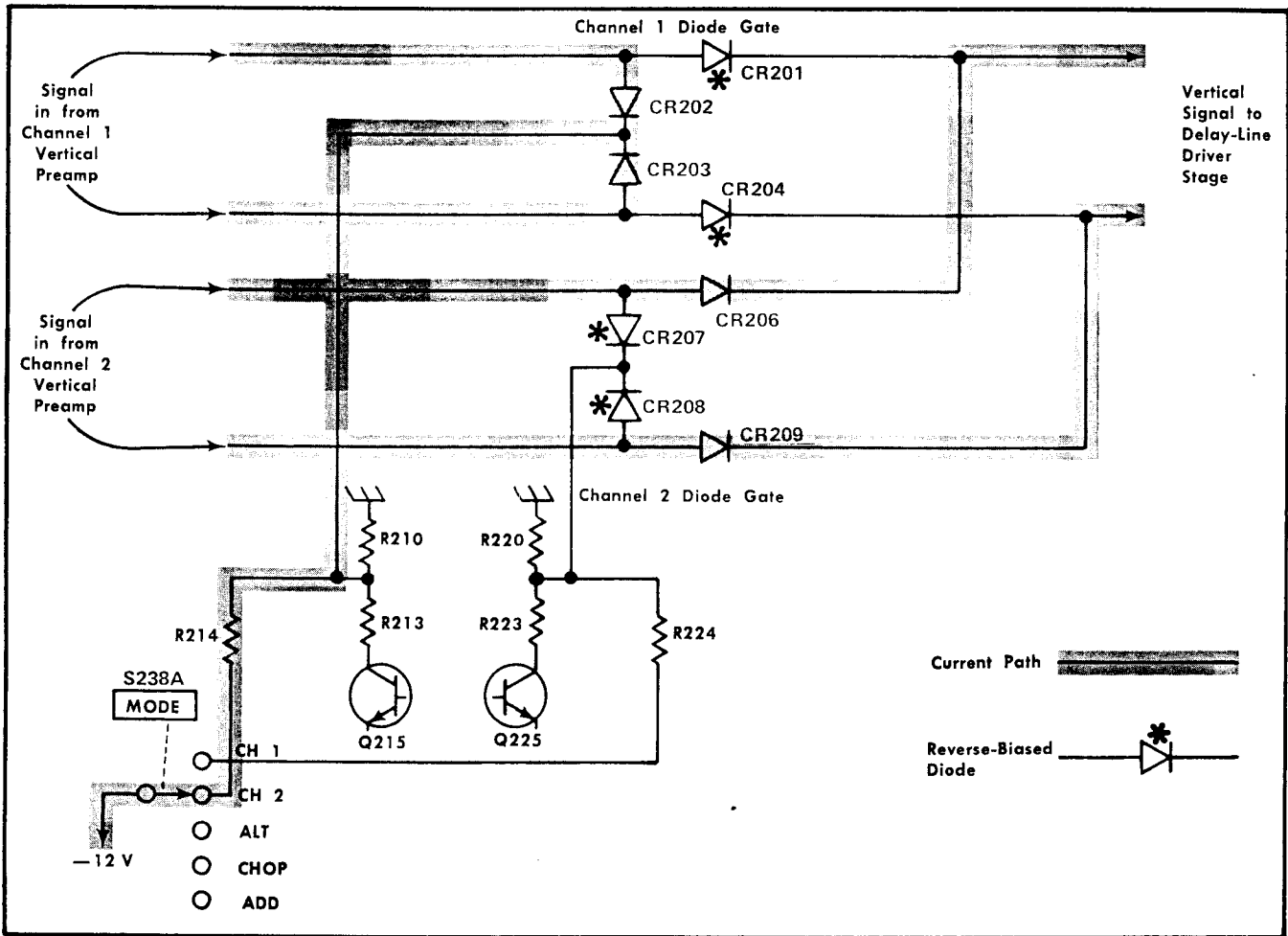

Fig. 3-6. Effect of Diode Gates on signal path (simplified diagram). Conditions shown for CH 2 position of the MODE switch.

movement at its collector holding the other transistor off. The conditions described previously are reversed; now the Channel 1 Diode Gate is reverse biased and the Channel 2 signal passes through the Channel 2 Diode Gate.

The Reference Feedback stage, Q253, provides common-mode voltage feedback from the Delay-Line Driver stage to allow the diode gates to be switched with a minimum amplitude switching signal. The emitter level of Q253 is connected to the junctions of the Switching Multivibrator collector resistors, R210-R213 and R220-R223 through CR212 or CR222. The collector level of the "on" Switching Multivibrator transistor is negative and either CR212 or CR222 is forward biased. This clamps the cathode level of the forward-biased shunt diodes in the applicable Diode Gate about 0.5 volt more negative than the emitter level of Q253. The shunt diodes are clamped near their switching level, and therefore they can be switched very fast with a minimum amplitude switching signal. The level at the emitter of Q253 follows the average voltage level at the emitters of the Delay-Line Driver stage. This maintains about the same voltage difference across the Diode Gate shunt diodes so they can be switched with a minimum amplitude switch-

ing signal regardless of the deflection signal at the anodes of the shunt diodes.

**CHOP.** In the CHOP position of the MODE switch, the Switching Multivibrator stage free runs as an astable multivibrator at about one-megahertz rate. The emitters of Q215 and Q225 are connected to -12 volts through R219 or R229 and the primary of T240. At the time of turn-on, one of the transistors begins to conduct; for example, Q225. Q225 conducts the Channel 2 current and prevents the Channel 2 signal from reaching the Delay-Line Driver stage. Meanwhile, the Channel 1 Diode Gate passes the Channel 1 signal to the Delay-Line Driver stage.

The frequency-determining components in the CHOP mode are C218-R219-R229. Switching action occurs as follows: When Q225 is on, C218 attempts to charge to -12 volts through R219. The emitter of Q215 slowly goes toward -12 volts as C218 charges. The base of Q215 is held at a negative point determined by voltage divider R216-R225 between -12 volts and the collector of Q225.

## Circuit Description—454A/R454A

When the emitter voltage of Q215 reaches a level slightly more negative than its base, Q215 conducts. Its collector level goes negative and pulls the base of Q225 negative through divider R215-R226 to cut Q225 off. This switches the Diode Gate stage to connect the opposite half to the Delay-Line Driver stage. Again C218 begins to charge toward  $-12$  volts, but this time through R229. The emitter of Q225 slowly goes negative as C218 charges, until Q225 turns on. Q215 is shut off and the cycle begins again.

Diodes CR218 and CR228 are prevented from conducting by CR234 and R234, which effectively remove them from the circuit in the CHOP mode. Q253 operates the same in the CHOP mode as in ALT to allow the Diode Gates to be switched with a minimum amplitude switching signal level.

The Chopped Blanking Amplifier stage, Q244, provides an output pulse to the Z Axis Amplifier circuit which blanks out the transitions between the Channel 1 and the Channel 2 trace. When the Switching Multivibrator stage changes states, the voltage across T240 momentarily increases. A negative pulse is applied to the base of Q244 to turn it off. The width of the pulse at the base of Q244 is determined by R241 and C241. Q244 is quickly driven into cutoff and the positive-going output pulse, which is coincident with trace switching, is connected to the Z Axis Amplifier circuit through R245.

**ADD.** In the ADD position of the MODE switch, the Diode Gate stage allows both signals to pass to the Delay-Line Driver stage. The Diode Gates are both held on by  $-12$  volts applied to their cathodes through R270 and R280. Since both signals are applied to the Delay-Line Driver stage, the output signal is the algebraic sum of the signals on both Channels 1 and 2.

### Delay-Line Driver

Output of the Diode Gate stage is applied to the Delay-Line Driver stage, Q274 and Q284. Q274 and Q284 are connected as feedback amplifiers with R276 and R286 providing feedback from the collector to the base of the respective transistor. Output of the Delay-Line Driver stage is connected to the Vertical Output Amplifier through the Delay Line.

### Normal Trigger Pickoff Emitter Follower

The Trigger signal for NORM trigger operation is obtained from the collector of Q274 through emitter follower Q293. The Normal Trigger DC Level adjustment, R272, sets the DC level of the normal trigger output signal so the sweep is triggered at the zero-volt level of the displayed signal when the Triggering LEVEL control is set to 0. The normal trigger signal is connected to the Trigger Preamp circuit through R294-C294 and S238B.

### Delay Line

The Delay Line provides approximately 120 nanoseconds delay for the vertical signal to allow the Sweep Generator circuits time to initiate a sweep before the vertical signal reaches the vertical deflection plates. This allows the instrument to display the leading edge of the signal originating the trigger pulse when using internal triggering.

## VERTICAL OUTPUT AMPLIFIER

### General

The Vertical Output Amplifier circuit provides the final amplification for the vertical deflection signal. The BANDWIDTH-BEAM FINDER switch provides bandwidth limiting in the up position, and compresses an overscanned display within the viewing area in the down position. This amplifier is unique in that many of the components are an integral part of the circuit board or are a part of the thick film etched circuitry used in the Output Push-Pull Amplifier. These parts are indicated on the diagram by an asterisk. Fig. 3-7 shows a detailed block diagram of the Vertical Output Amplifier circuit. A schematic of this circuit is shown on diagram 4 at the rear of this manual.

### Buffer Amplifier

The Buffer Amplifier stage, Q314 and Q414, provides a low input impedance for the Vertical Output Amplifier circuit. It also supplies a current drive to the Amplitude Compensation Network. C307 and R307 in the emitter of Q314, and C407 and R407 in the emitter of Q414, provide forward termination for the Delay Line. L308 and R308 between the emitters of Q314 and Q414 provide a method of thermal compensation whereby Q314 and Q414 generate an equal and opposite thermal distortion from that generated by Q374 and Q474.

### Amplitude Compensation Network

The Amplitude Compensation Network L318-R318 LR318-LR319-L418-LR418-LR419-R417-R418-R419 connected between the bases of Q324-Q424, provides a gradual boost in gain with increasing frequency to compensate for skin-effect losses in the Delay Line. R417 and R419 are adjustable to provide optimum compensation for the Delay Line losses.

### Push-Pull Amplifier Stages

**General.** The 12 transistors following the Buffer Amplifier stage form three similar, four-transistor amplifier stages. Fig. 3-8 shows a simplified circuit of the basic push-pull amplifier configuration. The current gain ( $i_{in}/i_{out}$ ) is slightly less than the ratio of  $R_s$  to  $R_e$ . The configuration used for each of these push-pull amplifier stages provides a

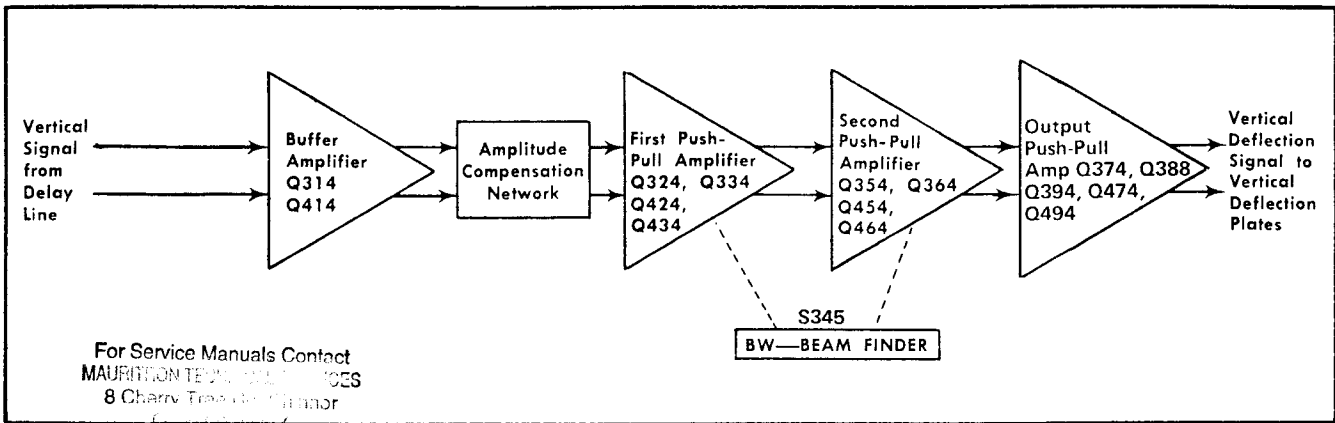

Fig. 3-7. Vertical Output Amplifier detailed block diagram.

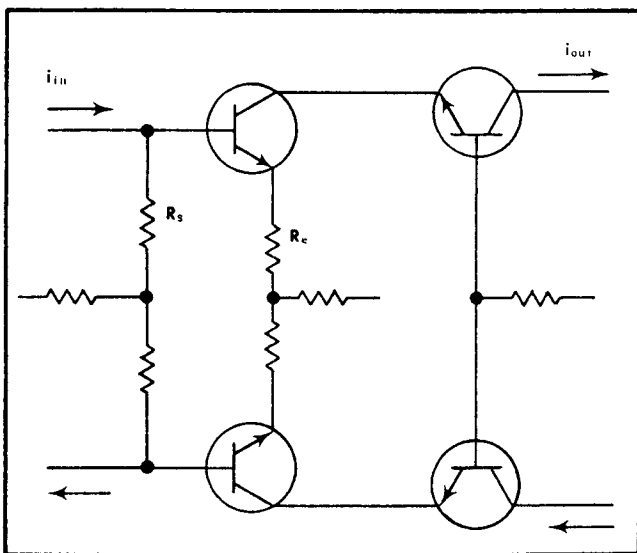

Fig. 3-8. Simplified circuit of Push-Pull Amplifier stages.

higher gain-bandwidth product than a single pair of transistors. The improved response results from the reduction in miller capacitance of the first pair of transistors (common emitter) because of the low input impedance of the second pair of transistors (common base).

**First Push-Pull Amplifier.** This stage has less than unity current gain at low frequencies, but the current gain at higher frequencies rises due to the compensating network in the emitter circuit of Q324 and Q424.

The emitter peaking network, C426-R426, compensates for the high-frequency rolloff at the vertical deflection plates due to the termination resistance and the capacitance of the output transistors, Q394 and Q494. Diodes CR323-CR324-CR325 along with thermistor R424 provide

thermal compensation to provide bandwidth stabilization. The diodes are held reverse biased and they appear in the circuit as a positive temperature coefficient capacitance. Thermistor R424 has a negative temperature coefficient. R424 and the diodes have a peaking effect which increases with temperature to counteract the opposite tendency of the basic amplifier. The Vertical Position Centering adjustment, R334, adjusts the quiescent DC levels in the Vertical Output Amplifier circuit to provide a centered trace when the inputs of the amplifier are at the same potential (shorted together).

**Second Push-Pull Amplifier.** The network C337-L334 L337-R333 and C437-L433-L435-L437 in the base circuit of Q354-Q454 provides inductive peaking for C353-R353 for optimum frequency response. Bandwidth limiting is provided by relay K442A when the BANDWIDTH-BEAM FINDER switch, S345, is in the 20 MHz position (up). When K442A is actuated a filter composed of C335-C435-L335-L435 is connected between the bases of Q354-Q454 which limits the bandwidth of the amplifier to about 20 megahertz. In the BEAM FINDER position, this switch limits the gain of Q354-Q454 to compress an off-screen display within the graticule area. Normally, the emitter current for Q354-Q454 is supplied through parallel paths S345-L343 and R340. When S345 is in the BEAM FINDER position, the current source through S345-L343 is interrupted and the only emitter current source for Q354-Q454 is through R340. With current being supplied only through R340, the emitter current of this stage drops to about 15% of the normal value and the display is compressed vertically within the graticule area.

The signal at the collectors of Q354-Q454 is connected to the emitters of Q364-Q464 through C355-R355-R356-R357 and C455-R455-R456-R457. R355 and R455 provide damping for the collectors of Q354-Q454. Transformer T358 reduces the common-mode signal components in the push-pull signal applied to the following stages.

**Output Push-Pull Amplifier.** The collector signal from Q364-Q464 is connected to the input of the first transistor pair of the Output Push-Pull Amplifier through C368-VR363-L368 and C468-L468-VR463. Zener diodes VR363 and VR463 provide the correct DC voltage match between Q364-Q374 and Q464-Q474 with a minimum of signal attenuation. C368-L368 and C468-L468 provide a constant load for Q364-Q464. The Vertical Gain adjustment, R365, varies the source resistance of Q374-Q474 to set the gain of the Vertical Output Amplifier circuit. Emitter follower Q388 and variable resistor R382 set the base voltage level of Q394-Q494, which in turn sets the collector voltage level of Q374-Q474. Zener diode VR388 protects Q394-Q494 if Q388 should fail by clamping their bases at about +26 volts.

The output signal is connected to the vertical deflection plates of the CRT through the buffer transistors Q394-Q494. A distributed deflection plate system is used in this instrument for maximum frequency response and sensitivity. The deflection signal from the Vertical Output Amplifier is connected to the integral inductors in the CRT, inductors L394-L494 and the terminating network C394-R394-R397 and C494-C495-R494-R495-R497. As the signal passes through the integral inductors in the CRT, its velocity is essentially the same as the velocity of the electron beam passing between the vertical deflection plates. This synchronism of the deflection signal and the electron beam reduces the loss in high frequency sensitivity due to electron transit time through the deflection plates. Inductors L394-L494 and resistors R394-R494 are adjusted to minimize signal reflections by providing the correct termination for the vertical deflection plate structure.

## TRIGGER PREAMP

### General

The Trigger Preamp circuit amplifies the internal trigger signal to the level necessary to drive the A and B Trigger Generator circuits. Input signal for the Trigger Preamp circuit is either a sample of the signal applied to Channel 1 or a sample of the composite vertical signal from the Vertical Switching circuit. This circuit also provides a signal to the Horizontal Amplifier for X-Y mode operation. Fig. 3-9 shows a detailed block diagram of the Trigger Preamp circuit. A schematic of this circuit is shown on diagram 5 at the back of this manual.

### Input Amplifier

The internal trigger signal from the Vertical Deflection System is connected to the Trigger Preamp Input Amplifier through the TRIGGER switch, S238B. When the TRIGGER switch is in the NORM position, the trigger signal is a sample of the composite vertical signal in the Vertical Switching circuit. This signal is obtained from the collector of Q274 and is a sample of the displayed channel (or chan-

nels for dual-trace operation). Since the signal source follows the Switching Multivibrator stage, the NORM trigger signal also includes the chopped switching transients when operating in the CHOP mode. When the TRIGGER switch is in the NORM position, the CH 1 lights, DS505 and DS506 are disconnected. Also, the sample of the Channel 1 signal is connected to the CH 1 OUT connector. This output signal can be used to monitor Channel 1 or it can be used in cascade with Channel 2 to provide a 400  $\mu$ V/division, uncalibrated, minimum deflection factor (with reduced bandwidth).

In the CH 1 ONLY OR X-Y position of the TRIGGER switch, the internal trigger signal is obtained from the emitter of Q54 in the Channel 1 Vertical Preamp circuit. Now, the internal trigger signal is a sample of only the signal applied to the INPUT CH 1 connector. The CH 1 lights are turned on to indicate that the TRIGGER switch is in the CH 1 ONLY position and the CH 1 OUT connector is disconnected from the circuit.

R501, R503 and R509 terminate the coaxial cables from the trigger pickoff stages to provide a constant load for these stages. In the NORM position of the TRIGGER switch, the trigger signal from the Vertical Switching circuit is terminated at the Input Amplifier by R509. The trigger signal from the CH 1 Vertical Preamp circuit is terminated at the Vertical MODE/TRIGGER switch by R501 and R502. In the CH 1 ONLY OR X-Y position, the trigger signal from the Channel 1 Vertical Preamp circuit is terminated at the Input Amplifier by R509 and the Vertical Switching circuit signal is terminated by R503.

The internal trigger signal selected by the TRIGGER switch is connected to the Input Amplifier stage, Q514 and Q524. CR516 in the emitter circuit of Q514 provides temperature compensation for this stage. Divider R514-R515 establishes a bias on CR516 which holds it in conduction throughout the dynamic range of the amplifier to insure that the emitter gain-setting resistor, R515, remains active in the circuit at all times. Zener diode VR521 provides a low-impedance source for the emitter of Q524. The signal at the collector of Q514 is connected to the base of Q524 through R517. R518 provides feedback of the output signal at the collector of Q524 to the emitter of Q514. This negative feedback provides consistent gain for the stage. The signal at the collector of Q524 is also connected to the Output Amplifier stage through R530. The Trigger Preamp DC Level adjustment, R511, sets the DC level at the collector of Q544 to zero volts when the input DC level for the amplifier is also at zero volts.

### Output Amplifier

The Output Amplifier stage is also a feedback amplifier similar to the Input Amplifier stage. The Input signal at the



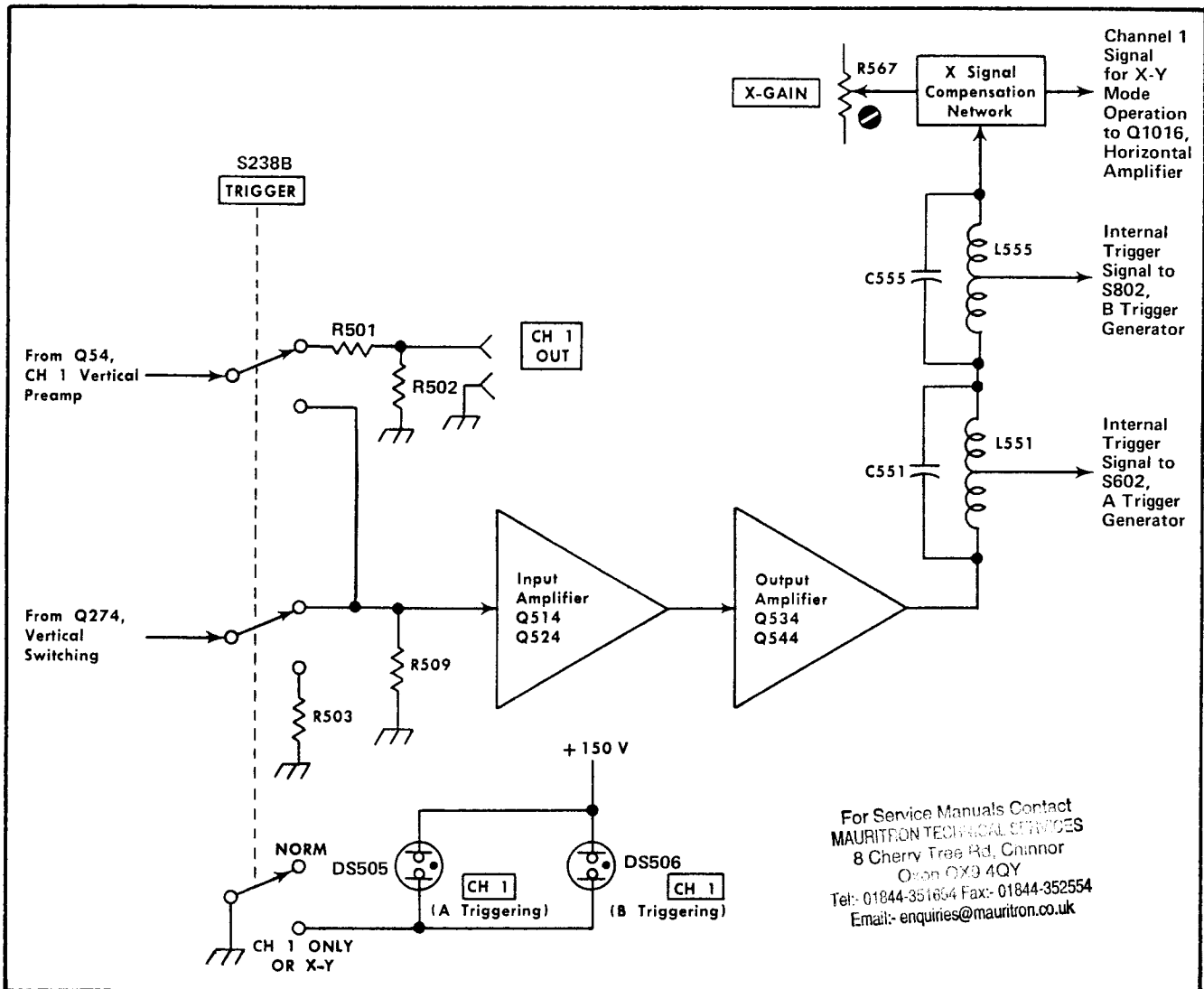

Fig. 3-9. Trigger Preamp detailed block diagram.

base of Q534 is amplified by Q534 and Q544. R536 connects the negative feedback from the collector of Q544 to the emitter of Q534. Zener diode VR543 provides a low impedance emitter source for Q544. The overall gain through the Input Amplifier and Output Amplifier stages is about 11; the Input Amplifier stage has a gain of about 3.9 and the Output Amplifier stage has a gain of about 2.9.

The load impedance for Q544 is provided by a transmission line distribution system. Two bridged-T transmission line sections pick off the trigger signals for the A and B Trigger Generator circuits. The capacitive load of the Trigger Generator circuits is the center element of each bridged-T section, C551-L551 and C555-L555. The two bridged-T sections are connected together with a 93-ohm coaxial cable to maintain a 93-ohm impedance all along the line.

R561, R563 and R565 provide the termination (about 93 ohms) for the simulated transmission line to minimize reflections and provide maximum frequency response. These resistors also form a voltage divider from the +12-volt supply to ground which, along with the quiescent current of Q544, establishes a quiescent level of about zero volts at the end of the transmission line. With little voltage drop through the simulated transmission line system, the quiescent DC voltage level at the collector of Q544 and the junction of R561-R563-R565 is essentially the same.

### X Signal Compensation Network

The X signal for X-Y mode operation is obtained at the termination of the simulated transmission line. The signal is connected through R565, R566 and a coaxial cable to the X-GAIN adjustment on the side-panel of the instrument.

## Circuit Description—454A/R454A

The X-GAIN adjustment, R567, provides signal attenuation to calibrate the X-axis deflection to the CH 1 VOLTS/DIV switch deflection factors when operating in the X-Y mode. The signal is then connected to the delay compensation network, C568-C569-L568-R569. C568-L568-C569 comprise a pi-section filter with a response that approximates a fixed delay. The delay of this network approximates the difference in delay between the X and Y channels (about 110 nanoseconds). The Horizontal Delay Compensation adjustment, R569, is adjusted for minimum phase shift at medium frequencies and L568 is adjusted for minimum phase shift at high frequencies. The resultant display provides accurate X-Y measurements up to about two megahertz; at higher frequencies the inherent phase shift between the X and Y channels may prevent accurate X-Y measurements. This difference in delay between the X and Y channels appears as a phase difference in the X-Y display and it increases rapidly above about two megahertz since the approximation of the delay compensation network is no longer valid. The output of the X Signal Compensation network is connected to the Horizontal Amplifier circuit.

## A TRIGGER GENERATOR

### General

The A Trigger Generator circuit produces trigger pulses to start the A Sweep Generator circuit. These trigger pulses are derived either from the internal trigger signal from the vertical deflection system, an external signal connected to the EXT TRIG INPUT connector, or a sample of the line voltage applied to the instrument. Controls are provided in this circuit to select trigger level, slope, coupling and source. Fig. 3-10 shows a detailed block diagram of the A Trigger Generator circuit. A schematic of this circuit is shown on diagram 6 at the back of this manual.

### Trigger Source

The A SOURCE switch, S602, selects the source of the A trigger signal. Three trigger sources are available; internal, line, and external. A fourth position of the A SOURCE switch provides 10 times attenuation for the external trigger signal.

The Internal trigger signal is obtained from the vertical deflection system through the Trigger Preamp circuit. This signal is a sample of the signal(s) applied to the INPUT CH 1 and/or CH 2 connectors. Further selection of the internal trigger source is provided by the TRIGGER switch to select the internal trigger signal from both channels, or from Channel 1 only (see Trigger Preamp discussion for details).

The line trigger signal is obtained from voltage divider R1104-R1105-R1106 in the Power Supply circuit. This sample of the line frequency, about 1.5 volts RMS, is coupled to the A Trigger Generator circuit in the LINE

position of the A SOURCE switch. The A COUPLING switch should not be in the LF-REJ position when using this trigger source, as the signal will be blocked by the LF reject circuit.

External trigger signals applied to the A EXT TRIG INPUT connector can be used to trigger the A sweep in the EXT and EXT  $\div$  10 positions of the A SOURCE switch. Input resistance at DC is about one megohm paralleled by about 15 pF in both external positions. However, when the A COUPLING switch is set to LF REJ, a 100-kilohm resistor, R609, is connected in parallel with the one-megohm input resistance (R614-R615), to provide attenuation of low-frequency signals. This provides an external input resistance of about 91 kilohms in this A COUPLING switch position. In the EXT  $\div$  10 position, a 10 times frequency-compensated attenuator is connected into the input circuit. This attenuator reduces the input signal amplitude 10 times to provide more A LEVEL control range, while maintaining the one-megohm X 15 pF input RC characteristics.

### Trigger Coupling

The A COUPLING switch, S608, offers a means of accepting or rejecting certain components of the trigger signal. In the AC and LF REJ positions of the A COUPLING switch, the DC component of the trigger signal is blocked by coupling capacitor C606 or C607. Frequency components below about 60 hertz are attenuated in the AC position, and below about 50 kilohertz in the LF REJ position, while the higher-frequency components of the trigger signal are passed without attenuation.

High-frequency components of the trigger signal are attenuated in the HF REJ position. The trigger signal is AC coupled to the input, attenuating signals below about 60 hertz and above about 50 kilohertz. The DC position passes all signals from DC to 150 megahertz.

### Input Source Follower

The Input Source Follower, Q623, provides a high input impedance for the trigger signal. It also provides isolation between the A Trigger Generator circuit and the trigger signal source. Diode CR623 protects Q623 if excessive input voltage is applied to the A EXT TRIG INPUT connector. The output signal at the source of Q623 is connected to emitter follower stage Q624, whose output is connected to the Slope Comparator stage.

### Slope Comparator

Q636 and Q646 are connected as a difference amplifier (comparator) to provide selection of the slope and level at which the sweep is triggered. The reference voltage for the comparator is provided by the A LEVEL control, R649,

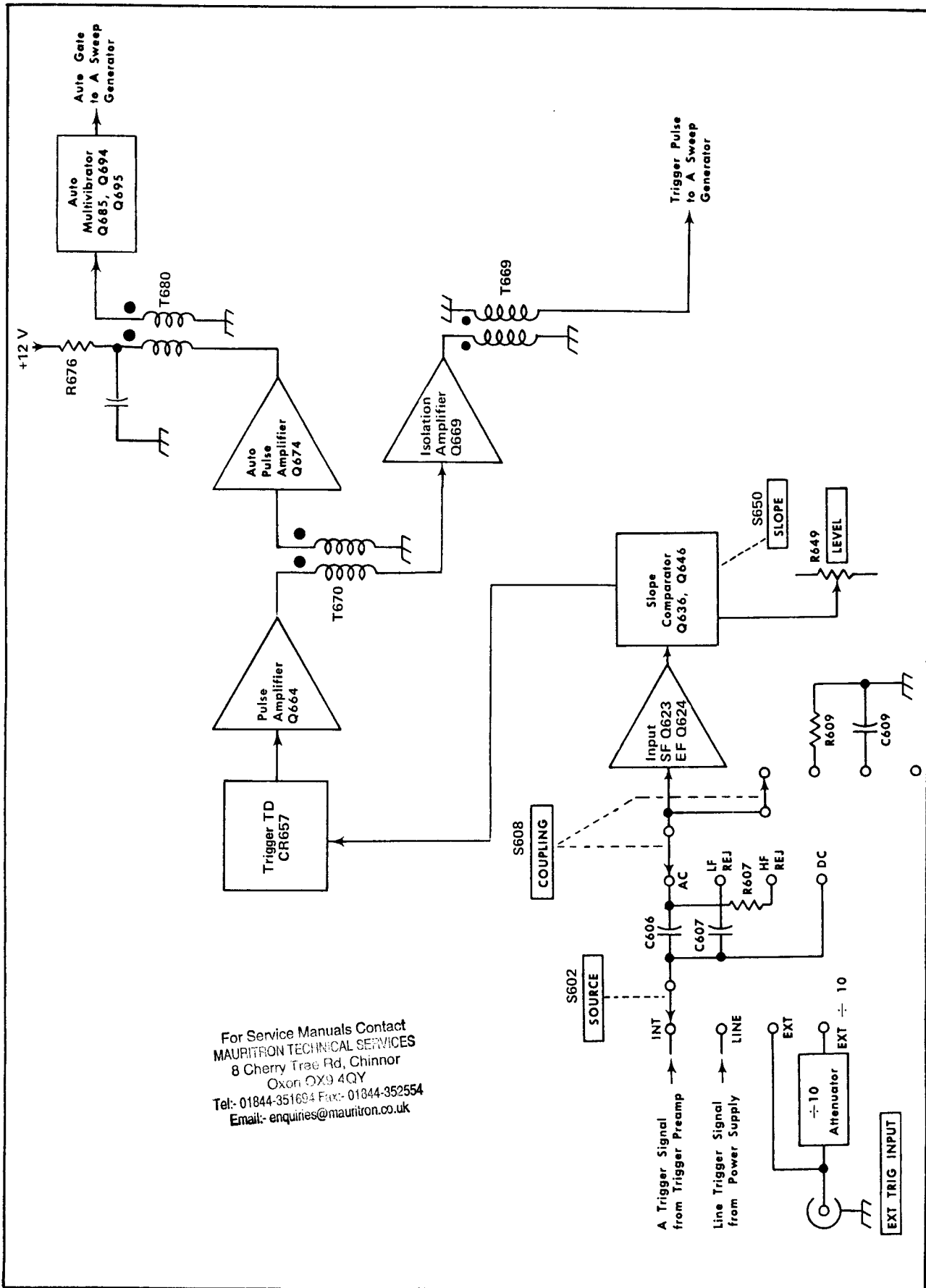

For Service Manuals Contact  
 MAURITRON TECHNICAL SERVICES  
 8 Cherry Tree Rd, Chinnor  
 Oxon OX9 4QY  
 Tel: 01844-351694 Fax: 01844-352554  
 Email: enquires@mauritron.co.uk

Fig. 3-10. A Trigger Generator detailed block diagram.

## Circuit Description—454A/R454A

and the A Trigger Level Center adjustment R643. The A Trigger Level Center sets the level at the base of Q646 so the display is correctly triggered when the A LEVEL control is centered. The A LEVEL control varies the base level of Q646 to select the point on the trigger signal where triggering occurs.

Diodes CR636-VR641 and CR638-VR642 limit the trigger signal change at the base of Q636 to about two volts more positive and negative than the level at the base of Q646. For example, as the base of Q646 rises positive when the A LEVEL control is turned clockwise, the voltage at the cathode of zener diode VR641 rises positive along with the change at the base of Q646, but it remains three volts more positive. Therefore, when the trigger signal level at the base of Q636 rises more than about 3.5 volts more positive than the base of Q646, CR636 is forward biased to limit the signal excursion. The action is similar for CR638-VR642 on negative-going signals. This configuration provides protection for the Slope Comparator stage from high-amplitude trigger signals.

R637 establishes the emitter current of Q636 and Q646. The transistor with the most positive base controls conduction of the comparator. For example, assume that the trigger signal at the emitter of Q624 is positive-going and Q636 is forward biased. The increased current through R637 produces a larger voltage drop, and the emitters of both Q636 and Q646 go more positive. A more positive voltage at the emitter of Q646 reverse biases this transistor, since its base is held at the voltage set by the A LEVEL control, and its collector current decreases. At the same time, Q636 is forward biased and its collector current increases. (Note: There is a narrow region at the switch-over point where both transistors conduct as a linear amplifier). Notice that the signal currents at the collectors of Q636 and Q646 are opposite in phase. The sweep can be triggered from either the negative-going or positive-going slope of the input trigger signal by producing the trigger pulse from either the signal at the collector of Q646 for - slope operation, or the signal at the collector of Q636 for + slope operation. This selection is made by the A SLOPE switch, S650.

When the A LEVEL control is set to 0 (midrange), the base of Q646 is at about -0.25 volt. The base-emitter drop of Q646 sets the common emitter level of Q636-Q646 to about one volt negative. Since the base of Q636 must be about 0.65 volt more positive than its emitter before it can conduct, the comparator switches around the zero-volt level of the trigger signal (zero-volt level on the trigger signal corresponds to about -0.25 volt at this point, with correct calibration). As the A LEVEL control is turned clockwise toward +, the voltage at the base of Q646 becomes more positive. This increases the current flow through R637 to produce a more positive voltage on the emitters of both Q636 and Q646. Now the trigger signal must rise more

positive before Q636 is biased on. The resultant CRT display starts at a more positive point on the displayed signal. When the A LEVEL control is in the - region, the effect is the opposite to produce a resultant CRT display which starts at a more negative point on the trigger signal.

The slope of the input signal which triggers the A sweep is determined by the A SLOPE switch, S650. When the A SLOPE switch is set to the - position, the collector of Q636 is connected to the +12-volt supply through CR651, R651 and R658. The anode of CR652 is grounded through R652, and this diode is reverse biased. Now the collector current of Q646 must flow through CR655, R656, L656, the parallel combination of CR657 and R666-L664, R659 and R658 to the +12-volt supply (see Fig. 3-11). Since the output pulse from the A Trigger Generator circuit is derived from the negative-going portion of the signal applied to the Trigger TD stage, the sweep is triggered on the negative-going slope of the input trigger signal (signal applied to Trigger TD stage is in phase with the input signal for - slope triggering). When the A SLOPE switch is set to +, conditions are reversed (see Fig. 3-12). Q646 is connected to the +12-volt supply through CR652, R652 and R658. The anode of CR651 is grounded through R651 to divert the collector current of Q636 through the Trigger TD stage. The signal applied to the Trigger TD stage is now 180° out of phase with the input trigger signal, and the sweep is triggered on the positive-going portion of the input signal.

### Trigger TD

The Trigger TD stage shapes the output of the Slope Comparator to provide a trigger pulse with a fast leading edge. Tunnel diode CR657 is quiescently biased so it operates in its low-voltage state. The current from one of the transistors in the Slope Comparator stage is diverted through the Trigger TD stage by the A SLOPE switch. As this current increases due to a change in the trigger signal, tunnel diode CR657 switches to its high-voltage state. L664 opposes this sudden change in current, which allows more current to pass through CR657 and switch it more quickly. As the current flow stabilizes, L664 again conducts the major part of the current. However, the current through CR657 remains high enough to hold it in its high-voltage state. The circuit remains in this condition until the current from the Slope Comparator stage decreases due to a change in the trigger signal applied to the input. Then, the current through CR657 decreases and it reverts to its low-voltage state.

### Pulse Amplifier

The trigger signal from the Trigger TD stage is connected to the base of the Pulse Amplifier, Q664, through R666, C666, and one half of L664. The trigger pulse at this point is basically a narrow, negative-going pulse with a fast rise.

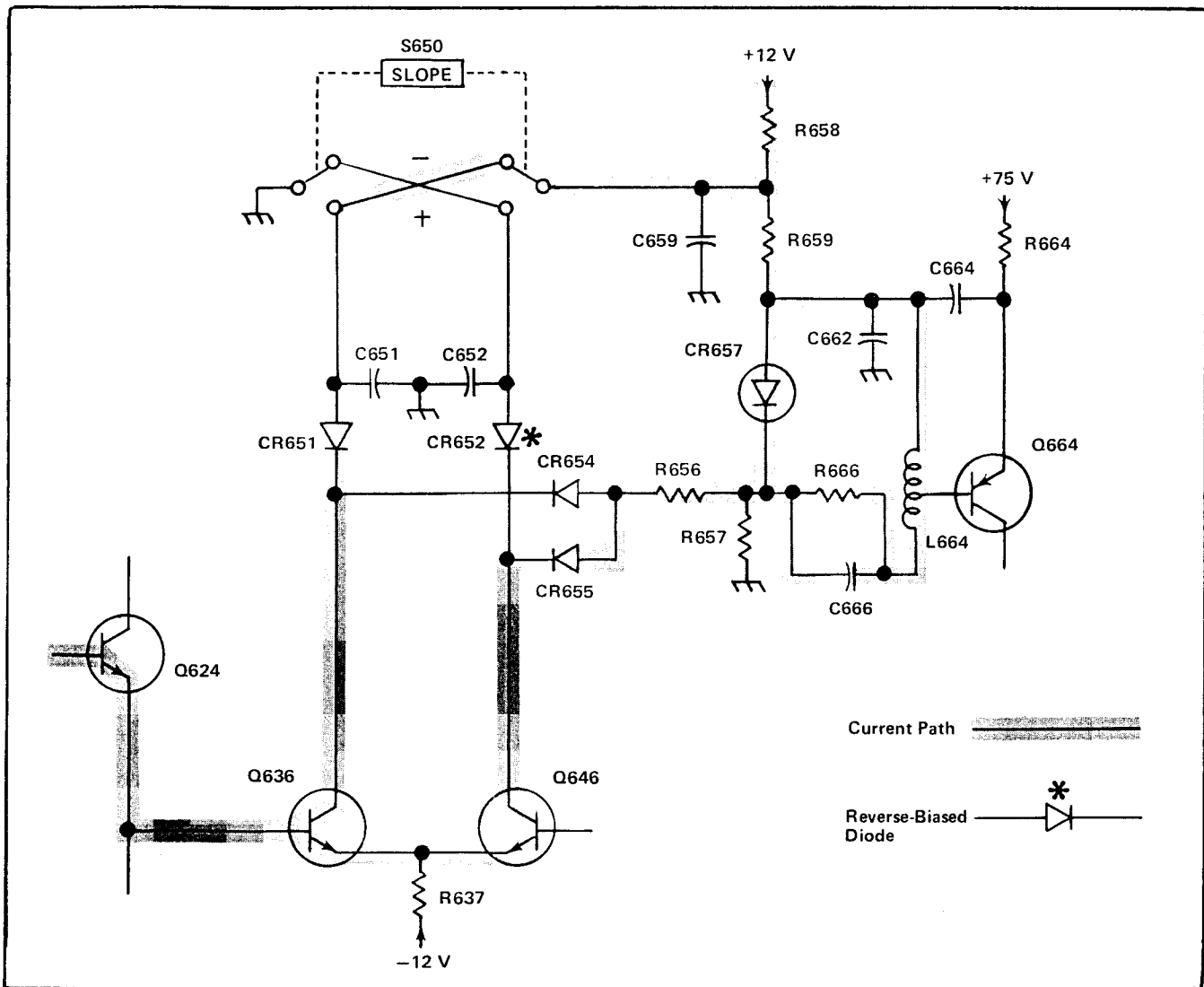

Fig. 3-11. Trigger path for negative-slope triggering (simplified A Trigger diagram).

Q664 is connected as an amplifier, with the primary of transformer T670, in series with the emitter of Q669 providing the collector load. The negative-going pulse at the base of Q664 drives it into heavy conduction, and the resulting current increase of Q664 flows through T670, C664, R659 and R658. Due to the short time-constant of the LR network involving R666-L664, the current of Q664 quickly returns to the level determined by R664 and the collector load. The resultant signal at the collector of Q664 is a positive-going fast-rise pulse with the width determined by the time constant of the LR network in the circuit. The signal in the secondary of T670 is a positive-going pulse, coincident with the rise of the output signal from the trigger TD stage.

### Isolation Amplifier

The fast-rise pulse from the collector circuit of Pulse Amplifier Q664 is applied to the emitter of Isolation

Amplifier Q669 through the primary winding of transformer T670. Q669 is connected as a grounded-base amplifier, with the primary of transformer T669 providing the only collector load. The positive-going signal at the emitter of Q669 causes Q669 to conduct heavier, with the increased collector current flowing through the primary of transformer T669. The output signal from the secondary of transformer T669 is a negative-going signal that is applied through CR671 and C671 to the sweep-gating tunnel diode in the A Sweep Generator circuit.

### Auto Pulse Amplifier

The positive-going trigger pulse from the secondary winding of T670 is connected to the base of Q674. This stage is similar in configuration to the Pulse Amplifier stage. The primary of pulse transformer T680 provides the major collector load for this stage. The positive-going trigger pulse is inverted through Q674 and T680 to produce a positive-

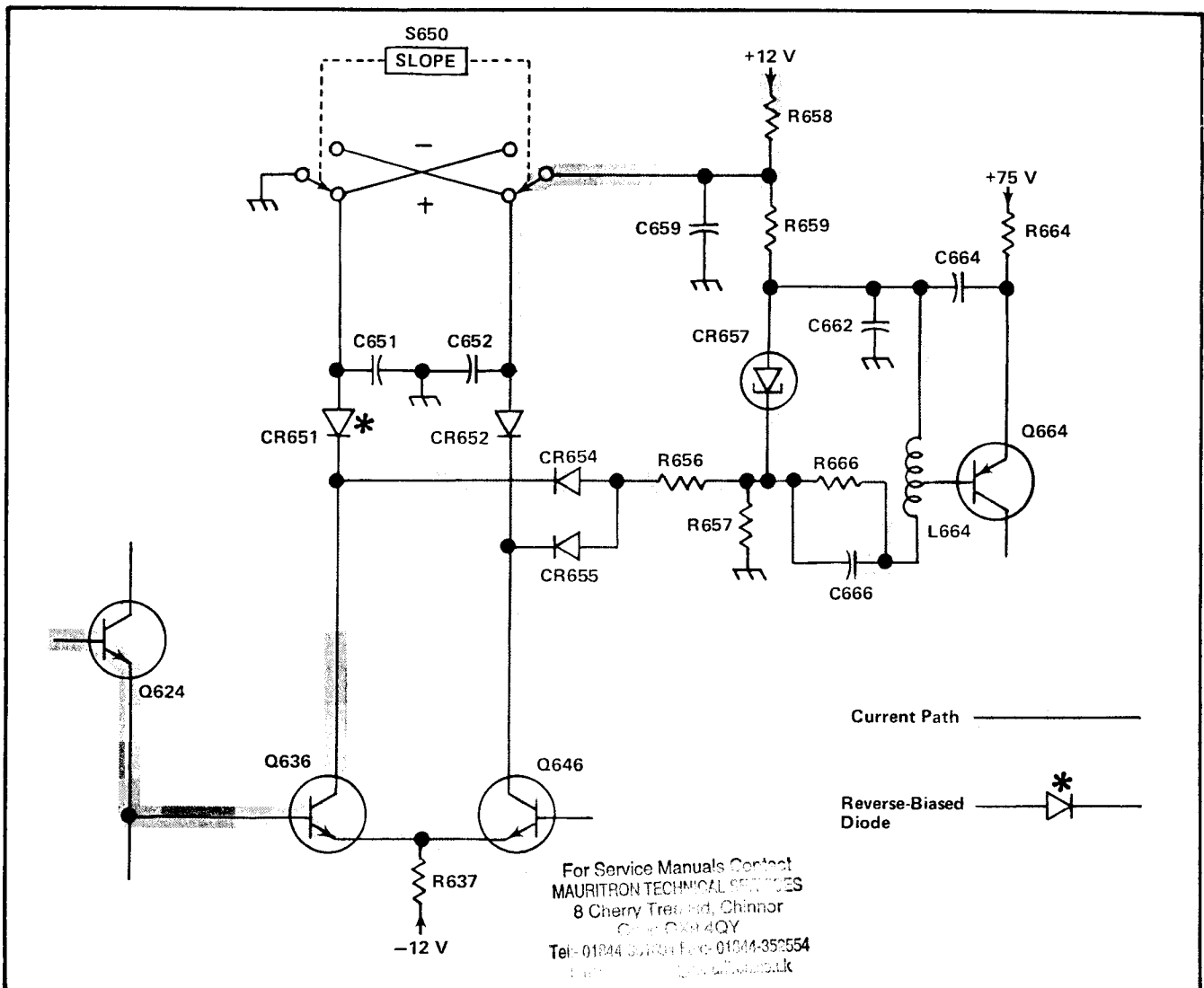

Fig. 3-12. Trigger path for positive-slope triggering (simplified A Trigger Generator diagram).

going pulse at the base of Q685. CR680 blocks any negative-going pulses in the secondary of T680.

there is no current flow through Q694, its collector level goes negative.

### Auto Multivibrator

The basic configuration of the Auto Multivibrator stage is a monostable multivibrator made up of Q685 and Q695. This stage produces the control pulse for the auto-trigger gate circuits located in the A Sweep Generator circuit. Under quiescent conditions (no trigger signal), the base of Q695 is held at about -0.3 volt by voltage divider R696-R697-LR695. The base of Q685 is held at about -0.65 volt by the forward voltage drop of CR681. Since the base of Q695 is the more positive, it conducts and raises the emitter level of Q685 positive enough to hold it off. C689 charges to about +13 volts through R685, where it is clamped by CR687 and CR692. The base of Q694 is held at about +12.6 volts by CR692, which reverse biases it. Since

When a trigger signal is present, the positive-going pulses from the Auto Pulse Amplifier stage turn Q685 on. The collector of Q685 goes negative and C689 discharges rapidly through Q685, R699, R696 and LR695. As C689 discharges, the current flow through R696 and LR695 holds Q695 off. When C689 is fully discharged, the current flow through R696 and LR695 ceases, and Q695 comes back on to reset the multivibrator. Now C689 begins to charge towards +75 volts through R685. Current also flows through R690 and the base of Q694 goes negative to bias it on. The collector level of Q694 rises positive to produce the auto gate output for the A Sweep Generator circuit.

If the multivibrator does not receive another Trigger Pulse, C689 recharges to about +13 volts in about 85 milliseconds. Then Q694 is biased off to end the auto gate (display free runs or is unstable). However, if a repetitive trigger signal turns Q685 on again before C689 has recharged to +13 volts, C689 is discharged completely again and once more starts to charge towards +75 volts. Since the base of Q694 remains negative enough with a repetitive trigger signal to hold it in conduction, the auto gate output level is continuous to produce a triggered display (see Auto Trigger Mode operation in the A Sweep Generator description).

## A SWEEP GENERATOR

### General

The A Sweep Generator circuit produces a sawtooth voltage which is amplified by the Horizontal Amplifier circuit to provide horizontal sweep deflection on the CRT. This output signal is generated on command (trigger pulse) from the A Trigger Generator circuit. The A Sweep Generator circuit also produces an unblanking gate to unblank the CRT during A sweep time. In addition, this circuit produces several control signals for other circuits within this instrument and two output signals to the side-panel connectors. Fig. 3-13 shows a detailed block diagram of the A Sweep Generator circuit. A schematic of this circuit is shown on diagram 7 at the back of this manual.

The A SWEEP MODE allows three modes of operation. In the NORM TRIG position, a sweep is produced only when a trigger pulse is received from the A Trigger Generator circuit. Operation in the AUTO TRIG position is much the same as NORM TRIG, except that a free-running trace is displayed when a trigger pulse is not present, or when the amplitude of the trigger signal is not adequate. In the SINGLE SWEEP position, operation is also similar to NORM TRIG, except that the sweep is not recurrent. The following circuit description is given with the A SWEEP MODE switch set to NORM TRIG. Differences in operation for the other two modes are discussed later.

### Normal Trigger Mode Operation

**Sweep Gate.** The negative-going trigger pulse generated by the A Trigger Generator circuit is applied to the Sweep Gate stage through CR701. Tunnel diode CR702 is quiescently biased on in its low-voltage state. When the negative-going trigger pulse is applied to its cathode, the current through CR702 increases and it rapidly switches to its high-voltage state, where it remains until reset by the Sweep Reset Multivibrator stage at the end of the sweep. The negative-going level at the cathode of CR702 is connected to the base of Q704 through C702 and R702. Q704 is turned on and its collector goes positive. This positive-going step is coupled through R704 to the Disconnect Amplifier and the Output Signal Amplifier.

**Output Signal Amplifier.** The positive-going gate pulse from the Sweep Gate stage is applied to the base of Q716. The resultant negative-going signal at the collector of Q716 provides the A unblanking gate signal, and is also connected to the Holdoff Driver stage. CR715 prevents the signal level at the anode of CR717 from going more negative than about  $-0.5$  volt. In all positions of the HORIZ DISPLAY switch S1001A except X-Y, current is connected to the anode of CR717 through R717. Before the A Sweep Gate stage is switched, this current flows through CR717 from the Z Axis Amplifier circuit and the CRT is blanked. When the A Sweep Gate stage switches and the collector of Q716 goes negative, CR717 is reverse biased and the current from R717 is shunted by Q716. CR717 is reverse biased and the CRT is unblanked to allow the A sweep to be displayed. In the A INTEN DURING B position of S1001A, additional current is added to the circuit at the cathode of CR717 through R719 and R950 (in B Sweep Generator circuit). This additional current reduces the intensity level of the CRT display during A sweep time. Then, when the B Sweep Generator produces an unblanking gate, this current is shunted by the B unblanking gate and a brightened portion is produced on the display which is coincident with the B sweep time.

In the X-Y position of the HORIZ DISPLAY switch, +12 volts is connected to the cathode of CR717 through R718. This holds CR717 reverse biased to block the A unblanking gate. The X-Y intensity level is established by the current through R718, the INTENSITY control setting, and the level established by the HORIZ DISPLAY switch in the Z Axis Amplifier circuit (see Z Axis Amplifier discussion).

**A Gate Output.** The positive-going gate signal at the base of Q716 is emitter-coupled to Q726. This positive-going signal at the emitter of Q726 cuts it off, and the resulting positive-going signal at its collector is coupled to the Vertical Switching circuit through C728 to provide an alternate-trace sync pulse for dual-trace operation. It is also coupled to the A + GATE output connector on the side panel through R727 to provide a gate signal (about +12 volts in amplitude) which is coincident with the A sweep. CR726 clamps the collector of Q726 at about  $-0.5$  volt when it is conducting.

**Holdoff Driver.** The negative-going signal at the collector of Q716 when the sweep begins is connected to the Holdoff Capacitor through Q714. This negative-going signal discharges the Holdoff Capacitor completely at the start of each sweep to provide accurate sweep holdoff time. CR710 clamps the collector of Q714 so it does not go more negative than about  $-0.5$  volt.

**Disconnect Amplifier.** The Disconnect Amplifier, Q724, is quiescently conducting current through R759, Timing

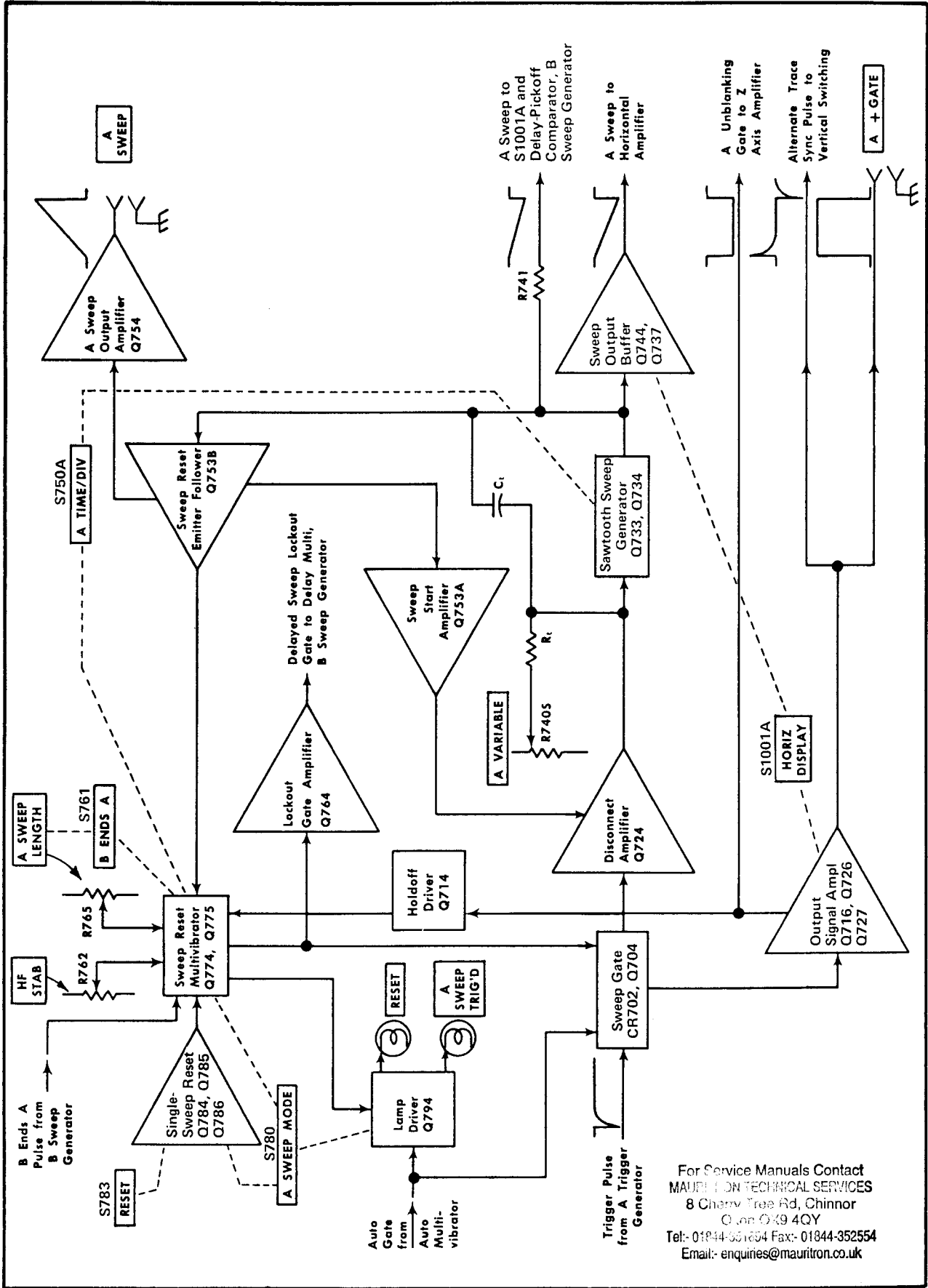

Fig. 3-13. A Sweep Generator detailed block diagram.



Resistor R740, and A SWEEP CAL R743. Timing current is prevented from charging the timing capacitance. The positive-going gate signal from Q704 reverse biases Q724 through CR709, and the quiescent current flow is interrupted. Now the timing current through the Timing Resistor begins to charge Timing Capacitor, C740, so the Sawtooth Sweep Generator stage can produce a sawtooth output signal. The positive-going gate signal also reverse biases CR759 to disconnect the Sweep Start Amplifier. The Disconnect Amplifier is a fast turn-off transistor to reduce the switching time, and improve timing linearity at the start of the sweep.

**Sawtooth Sweep Generator.** The basic sweep generator circuit is a Miller Integrator circuit. When the current flow through the Disconnect Amplifier stage is interrupted by the sweep gate signal, the Timing Capacitor,  $C_T$ , begins to charge through the Timing Resistor,  $R_T$ , and A Sweep Cal R743. The Timing Capacitor and Resistor are selected by the A TIME/DIV switch to provide the various sweep rates listed on the front panel. Diagram 10 shows a complete diagram of the A TIME/DIV switch. The A Sweep Cal adjustment allows calibration of this circuit for accurate sweep timing. A VARIABLE control R740S (see Timing Switch diagram), provides continuously variable, uncalibrated sweep rates by varying the charge rate of the Timing Capacitor.

As the Timing Capacitor begins to charge positive towards the voltage applied to the Timing Resistor, the gate of Q733 rises positive also. This produces a positive-going change at the source of Q733 which is coupled to the base of Q734 through R735. Q734 amplifies and inverts the voltage change at the source of Q733 to produce a negative-going sawtooth output. CR735 clamps the base of Q734 at about  $-0.5$  volt to protect Q734 during instrument turn-on. To provide a linear charging rate for the Timing Capacitor, the sweep output signal is connected to the negative side of C740. This feedback provides a constant charging current for C740, which maintains a constant charge rate to produce a linear sawtooth output signal. The output voltage continues to go negative until the circuit is reset through the Sweep Reset Multivibrator. The output signal from the collector of Q734 is connected to emitter follower Q737 through R736, and to the Delay Pickoff Comparator stage in the B Sweep Generator circuit through R741.

**Sweep Output Buffer.** The Sweep Output Buffer stage, Q744, is a current-driven stage. It provides the output sawtooth current to the Horizontal Amplifier circuit. The HORIZ DISPLAY switch is connected to this stage to control the A sawtooth output in the various horizontal modes of operation. In the A and A INTEN DURING B positions, Q744 operates as described. However, in the B (DELAYED SWEEP), MIXED and X-Y positions,  $-12$  volts is connected to the emitter of Q744 through R739. CR732 is forward biased to clamp the emitter of Q744 at about  $-0.5$  volt. Q744 is reverse biased and it blocks the A sawtooth output.

**Sweep Reset Emitter Follower.** The negative-going sawtooth voltage at the collector of Q734 is connected to the base of the Sweep Reset Emitter Follower stage, Q753B, through R749. The negative-going signal at the emitter of Q753B is coupled to the Sweep Reset Multivibrator stage to determine sweep length and to the Sweep Start Amplifier stage to set the starting point for the sweep. It is also connected to the A Sweep Output Buffer stage by way of emitter follower Q737 to provide a sawtooth output signal. CR749 connected to the base of Q753B protects this stage during instrument warmup.

**Sweep Start Amplifier.** The signal at the emitter of Q753B goes negative along with the applied sawtooth signal. This increases the forward bias on CR757B, which in turn decreases the forward bias on CR757A. When the anode of CR757A reaches a level about one volt more negative than the level on the base of Q753A, it is reverse biased to interrupt the current flow through Q753A. The circuit remains in this condition until after the sweep retrace is complete. As the voltage at the emitter of Q753B returns to its original DC level at the end of the sweep, CR757A is again forward biased and Q753A conducts through CR759 to set the quiescent current through Q724. This establishes the correct starting point for the sweep. CR721 clamps the collector of Q753A about  $0.5$  volt more positive than the base of Q724 when Q753A is off (during sweep and retrace time). This holds the collector of Q753A close to the emitter level of Q724 while Q753A is off, so that when it turns on, the voltage swing at the collector of Q753A is small and the response time is short. The Sweep Start adjustment, R843, (in the B Sweep Generator circuit) sets the base voltage level of Q753A. The collector of Q734 is held at this same voltage level by the negative feedback loop Q724-Q733-Q734, thereby setting the starting point for the sweep. The level established by the Sweep Start adjustment is also connected to the B Sweep Start Amplifier, so the B sweep starts at the same point as the A sweep.

**A Sweep Output Amplifier.** The negative-going sawtooth signal at the emitter of Q753B is connected to the base of Q754 through R755. Q754 amplifies and inverts this signal to produce a positive-going sweep output signal at the A SWEEP connector on the side panel. CR750 protects Q754 if a high-amplitude negative voltage is accidentally applied to the A SWEEP connector.

**Sweep Reset Multivibrator.** The negative-going sawtooth at the emitter of Q753B is coupled to the cathodes of CR760 and CR761. These diodes are quiescently reverse biased at the start of the sweep. As the sawtooth voltage at the cathode of CR761 goes negative, CR761 is forward biased at a level about  $0.5$  volt more negative than the base level of Q775 (A SWEEP LENGTH control in FULL position). Then the negative-going sawtooth signal from the Sweep Reset Emitter Follower stage is connected to the base of Q775 through R776. Q774 and Q775 are connected

## Circuit Description—454A/R454A

as a Schmitt bistable multivibrator. Quiescently, at the start of the sweep, Q774 is conducting and Q775 is biased off to produce a negative level at its collector. This negative level allows the Sweep Gate tunnel diode, CR702, to be switched to produce a sweep as discussed previously. When the negative-going sweep signal is connected to the base of Q775 through CR761, Q775 is eventually biased on and Q774 is biased off by the emitter coupling between Q774-Q775. The collector of Q775 rises positive and CR702 is switched back to its low-voltage state through R701. This turns Q704 and Q716 off, and Q724 and Q726 on to rapidly discharge the Timing Capacitor and produce the retrace portion of the sawtooth signal. The Sawtooth Sweep Generator stage is now ready to produce another sweep, as soon as the Sweep Reset Multivibrator stage is reset and another trigger pulse is received.

When Q775 is turned on to end the sweep, it remains in conduction for a period of time to establish a holdoff period and allow all circuits to return to their original conditions before the next sweep is produced. The holdoff time is determined by the charge rate of the Holdoff Capacitor, C760. At the start of the sweep, C760 is completely discharged by the unblanking gate through the Holdoff Driver, Q714. The Holdoff Capacitor is held at this level throughout the sweep time. Then, when Q704 is turned off, Q716 and Q714 are cut off. C760 begins to charge toward +75 volts through R761, R762 and R763. The positive-going voltage across the Holdoff Capacitor as it charges is connected to the base of Q775 through CR763 and VR766. When the base of Q775 rises positive enough so it is reverse biased, its collector level drops negative and Q774 comes back into conduction. The bias on the A Sweep Gate tunnel diode, CR702 returns to a level that allows it to accept the next trigger pulse (CR702 is enabled). The Holdoff Capacitor, C760, is changed by the A TIME/DIV switch for the various sweep rates to provide the correct holdoff time. Diagram 10 shows a complete diagram of the A TIME/DIV switch.

As the A SWEEP LENGTH control is rotated counterclockwise from the FULL position, CR760 controls the turn-off point of the Sweep Reset Multivibrator at a level determined by the setting of R765. R765 places a more positive level on the anode of CR760 than is on the anode of CR761, so CR761 remains reverse biased. The Sweep Reset Multivibrator is now reset as described for FULL operation at the point where CR760 (instead of CR761) is forward biased. Since this occurs at a more positive level on the negative-going sawtooth, the displayed sweep is shorter. Thus R765 provides a variable sweep length for the A sweep (from about 11 divisions in the FULL position to about four divisions in the fully clockwise position—not in B ENDS A detent). In the B ENDS A position (fully counterclockwise), a negative-going pulse from the B Sweep Generator circuit is connected to the base of Q775 through CR770 at the end of the B sweep time. If the A sweep is still running, this negative-going pulse turns on Q775 to end

the A sweep also. Since the A sweep ends immediately following the end of the B sweep, this position provides the maximum repetition rate (brightest trace) for Delayed Sweep mode operation.

The HF STAB control, R762, varies the charging rate of the Holdoff Capacitor to provide a stable display at fast sweep rates. This change in holdoff allows sweep synchronization for less display jitter at the faster sweep rates. This control has little effect at slow sweep rates.

**Lockout Gate Amplifier.** Q764 is a current switch which is driven by the collector signal of Q775 to produce the delayed sweep lockout gate. This negative-going gate at the collector of Q764 is connected to the Delay Multivibrator stage in the B Sweep Generator circuit to lock the B Sweep Generator out until the A Sweep Generator hold-off period is complete. CR769 sets the emitter voltage of Q764 at about -0.5 volt so Q764 turns on when its base is above zero volts.

**Lamp Driver.** The auto-gate level from the Auto Multivibrator stage in the A Trigger Generator circuit is connected to the Lamp Driver stage, Q794, through CR794 and CR795. This gate level is coincident with the trigger pulse generated by the A Trigger Generator circuit, and is present only when the instrument is correctly triggered. The positive-going auto-gate level at the base of Q794 drives Q794 into saturation. The collector of Q794 goes negative to about zero volts and the A SWEEP TRIG'D light, DS793, comes on. This light remains on as long as the auto-gate level is present. When the auto-gate level goes negative because the instrument is no longer triggered, CR793 clamps the base level of Q794 at about -0.5 volt and Q794 is reverse biased. The collector of Q794 rises positive and DS793 goes off.

## Auto Trigger Mode Operation

Operation of the A Sweep Generator circuit in the AUTO TRIG position of the A SWEEP MODE switch is the same as for the NORM TRIG position just described when a trigger pulse is present. However, when a trigger pulse is not present, a free-running reference trace is produced in the AUTO TRIG mode. This occurs as follows:

The auto-gate level from the Auto Multivibrator stage in the A Trigger Generator circuit is also connected to CR796. When the auto-gate level is positive (triggered), the current flowing through CR796 and R797 reverse biases CR797 and the Sweep Gate tunnel diode, CR702, operates as previously described for NORM TRIG operation. However, when the instrument is not triggered, the auto-gate level drops negative and the reduction in current through CR796 and R797 allows CR797 to become forward biased. Now, when the Sweep Reset Multivibrator stage resets at the end of the holdoff period, the additional current from

R797-CR797 flows through CR702 and is sufficient to automatically switch the Sweep Gate tunnel diode stage back into its high-voltage state. The result is that the A Sweep Generator circuit is automatically retriggered at the end of each holdoff period, and a free-running sweep is produced. Since the sweep free-runs at the sweep rate of the A Sweep Generator (as selected by the A TIME/DIV switch), a bright reference trace is produced even at fast sweep rates.

### Single Sweep Operation

**General.** Operation of the A Sweep Generator in the SINGLE SWEEP position of the A SWEEP MODE switch is similar to operation in the other modes. However, after one sweep has been produced, the Sweep Reset Multivibrator stage does not reset. All succeeding trigger pulses are locked out until the RESET button is pressed.

In the SINGLE SWEEP position, the A SWEEP MODE switch disconnects the charging current for the Holdoff Capacitor. Now, Q775 remains on when it is forward biased by the sweep through CR760 or CR761. With Q775 on, CR702 is held in its low-voltage state to lock out the incoming trigger pulses. The circuit remains in this condition until reset by the Single-Sweep Reset stage.

**Single-Sweep Reset.** The Single-Sweep Reset stage produces a pulse to reset the Sweep Reset Multivibrator stage so another sweep can be produced in the SINGLE SWEEP mode of operation. Quiescently, Q784 is held in conduction by the +12 volts applied to its base through R781. When the RESET button, S783, is pressed, the voltage at the base of Q784, as determined by voltage divider R781-R782, is near zero volts. Q784 is biased off and its collector slowly goes positive toward +12 volts. This positive-going change at the collector of Q784 is coupled to the emitter of Q785 through the network C784-C785-R784-R785. This network prevents noise or extraneous pulses from resetting the sweep. When the positive-going level at the emitter of Q785 reaches about +3 volts (base level of Q785 set by divider R771-R772-R773), it turns on and its collector rises positive to forward bias Q786. The collector of Q786 rapidly goes negative, which forces Q785 to conduct even harder. C787-R787 differentiate this negative-going change at the collector of Q786 and connect the fast negative-going pulse to the base of Q774. Q774 turns on and Q775 turns off to enable the Sweep Gate tunnel diode, CR702. Now the A Sweep Generator can be triggered when the next trigger pulse is received.

**Lamp Driver.** In the SINGLE SWEEP mode, the cathode of CR795 is connected to ground to block the incoming auto-gate pulse. The A SWEEP TRIG'D light, DS793, is disconnected from the collector of Q794 and the

RESET light. DS792, is connected into the circuit. The anode of CR793 is also disconnected from ground. Now, the condition of Q794 is determined by the Sweep Reset Multivibrator stage. When Q774 is off before the RESET button is pressed, the collector level of Q774 is negative. The current through R794-CR793-R791 sets the base level of Q794 negative enough to bias it off. However, when the RESET button is pressed and Q774 turns on, its collector goes positive. This positive level allows the base of Q794 to go positive also, and it is biased on. The collector of Q794 goes negative and the RESET light comes on. Q794 and the RESET light remain on until Q774 turns off again at the end of the next sweep.

## B TRIGGER GENERATOR

### General

The B Trigger Generator circuit is basically the same as the A Trigger Generator circuit. Only the differences between the two circuits are discussed here. Portions of the circuit not described in the following discussion operates in the same manner as for the A Trigger Generator circuit (corresponding circuit numbers are assigned in the 800-899 range). Fig. 3-14 shows a detailed block diagram of the B Trigger Generator circuit. A schematic of this circuit is shown on diagram 8 at the back of this manual.

### Input Source Follower

The Input Source Follower stage, Q823, and Emitter Follower, Q826, operate in basically the same manner as described for the A Trigger Generator circuit. However, in the B Trigger Generator circuit, the HORIZ DISPLAY switch, S1001A, blocks the B Trigger Generator input signal in the modes where B triggering is not desired. In the A and X-Y positions of the HORIZ DISPLAY switch, -12 volts is connected through R829 to the cathode of CR828. Since the cathode of CR833 is connected to +12 volts through R833, CR833 is reverse biased and it blocks the trigger signal. In the A INTEN DURING B. B (DELAYED SWEEP) and MIXED positions, a second switch, B SWEEP MODE S835, determines whether the trigger signal is blocked or passed to the Slope Comparator stage. If the B SWEEP MODE switch is in the B STARTS AFTER DELAY TIME position, the trigger signal is blocked as in the A or X-Y positions. However, the B Sweep Generator circuit free-runs in this position as controlled by another portion of the B SWEEP MODE switch located in the B Sweep Generator circuit. In the TRIGGERABLE AFTER DELAY TIME position, -12 volts is disconnected from the cathode of CR828 and connected to the cathode of CR833 through R835. CR833 is now forward biased and the trigger signal can pass to the Slope Comparator stage to produce the trigger pulse.

### Pulse Amplifier

The Pulse Amplifier stage in the B Trigger Generator circuit operates much the same as in the A Trigger

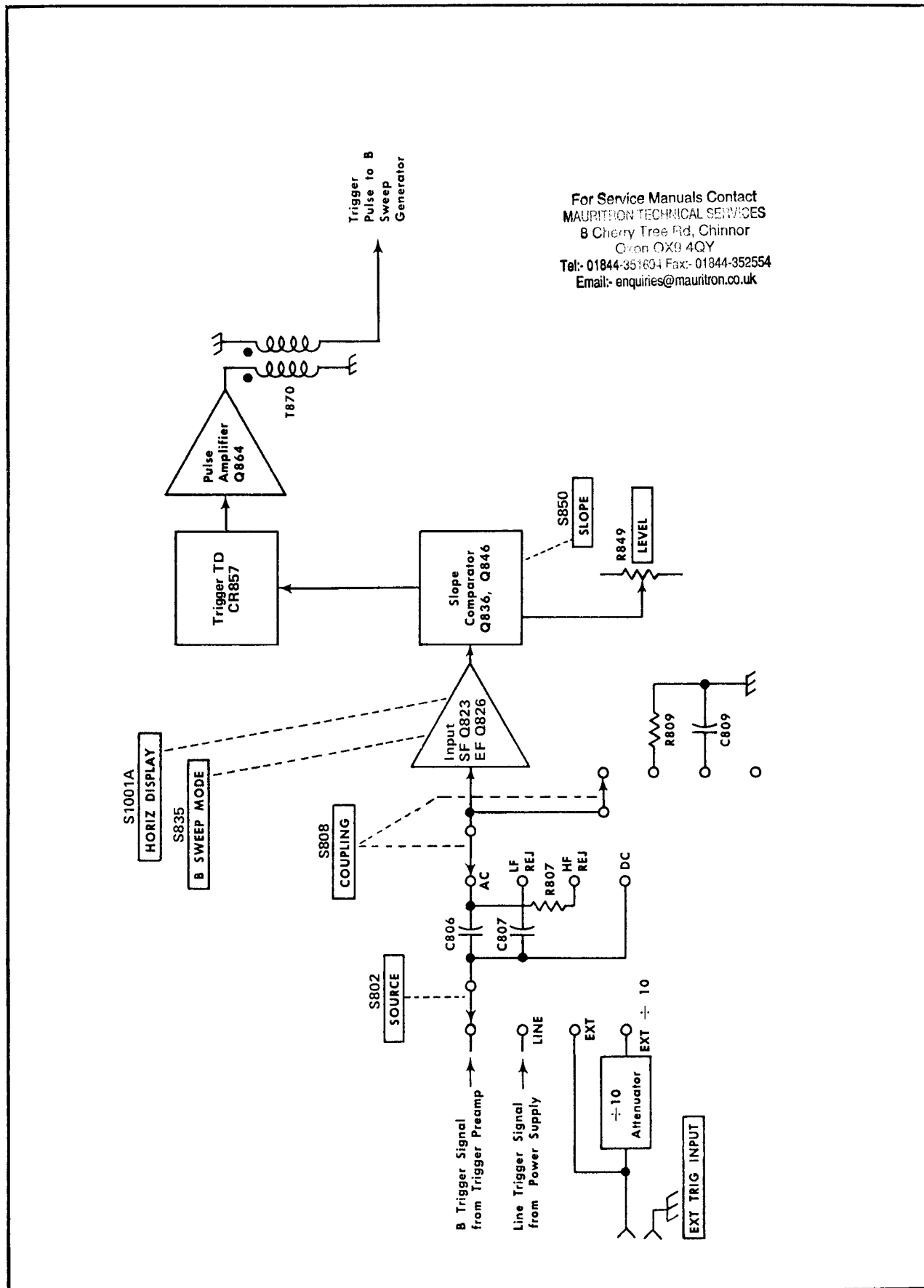

For Service Manuals Contact  
 MAURITRON TECHNICAL SERVICES  
 8 Cherry Tree Rd, Chinnor  
 Oxon OX9 4QY  
 Tel: 01844-351694 Fax: 01844-352554  
 Email: enquiries@mauritron.co.uk

Fig. 3-14. B Trigger Generator detailed block diagram.

Generator circuit. There is no Auto Trigger stage in the B Trigger Generator circuit; therefore, there is no need for an Auto Pulse Amplifier or Isolation Amplifier stage. The output from the secondary of pulse transformer T870 is applied to the B Sweep Generator circuit through C871.

## B SWEEP GENERATOR

### General

The B Sweep Generator circuit is basically the same as the A Sweep Generator circuit. Only the differences between the two circuits are discussed here. The following circuits operate as described for the A Sweep Generator (corresponding circuit numbers assigned in the 900-999 range): Sweep Gate (CR902, Q904), Disconnect Amplifier (Q919), Sawtooth Sweep Generator (Q921, Q925), and the Sweep Reset Emitter Follower (Q938B). Fig. 3-15 shows a detailed block diagram of the B Sweep Generator circuit. A schematic of this circuit is shown on diagram 9 at the back of this manual.

### Output Signal Amplifier

Basically, the B Output Signal Amplifier is the same as the corresponding circuit in the A Sweep Generator circuit. In the A, MIXED, and X-Y positions of the HORIZ DISPLAY switch, the B unblanking pulse is blocked, since there is no forward bias voltage applied to CR907 or CR908. In the A INTEN DURING B and the B (DELAYED SWEEP) positions, current is connected to the anodes of CR907 and CR908 through R949 or R950. When the Sweep Gate stage is in its low-voltage state, this current flows through CR908 to the Z Axis Amplifier circuit (through the A Sweep Generator circuit) and the CRT is blanked. When the B Sweep Gate stage switches to its high-voltage state at the start of B sweep, the collector of Q910 goes negative. This forward biases CR907 and the blanking current is diverted from CR908 through CR907. CR908 is reverse biased and the CRT is unblanked to allow the B sweep to be displayed. For A INTEN DURING B operation, the CRT display is partially unblanked during A sweep time and further unblanked during B sweep time (see the A Sweep Generator discussion). In the B (DELAYED SWEEP) position, the A unblanking pulse is blocked (see A Output Signal Amplifier discussion). In the MIXED position, the CRT display is partially unblanked at the start of the A sweep time and is further unblanked at the start of the B sweep time. At the end of the B sweep time the CRT display is completely blanked (see Mixed Sweep Blanking Multivibrator discussion).

### Delay-Pickoff Comparator

The Delay-Pickoff Comparator stage allows selection of the amount of delay from the start of the A sweep before the B Sweep Generator is turned on. This stage allows the start of B sweep to be delayed between 0.10 and 10.10 times the setting of the A TIME/DIV switch. Then, the B

Sweep Generator is turned on, and the display is presented at a sweep rate determined by the setting of the B TIME/DIV switch.

Q996A and B are connected as a voltage comparator. In this configuration, the transistor with the most positive base controls conduction. A dual transistor, Q996, and a dual diode, CR995, provide temperature stability for the comparator circuit. Q998 maintains a constant current through the conducting transistor. Reference voltage for the comparator circuit is provided by the DELAY-TIME MULTIPLIER control, R997. The voltage to this control is filtered by R946-C946 to remove transient noise voltages and allow precise delay pickoff. The instrument is calibrated so that the major dial markings of R997 correspond to the major divisions of horizontal deflection on the graticule. For example, if the DELAY-TIME MULTIPLIER dial is set to 5.00, the B Sweep Generator enable pulse is delayed an amount of time equal to five divisions of the A sweep before it can produce a sweep (for this example, B sweep delay time equals five times the setting of the A TIME/DIV switch).

The output sawtooth from the A Sawtooth Sweep Generator stage is connected to the base of Q996A. The quiescent level of the sawtooth biases Q996A on, and its collector is negative enough to hold Q984 in the Delay Multivibrator stage in conduction. As the A sweep output sawtooth goes negative, the base of Q996A also goes negative. When it goes more negative than the level at the base of Q996B (established by the DELAY-TIME MULTIPLIER control), Q996B takes over conduction of the comparator and Q996A shuts off. This also switches the Delay Multivibrator stage to produce the desired negative-going reset pulse to the B Sweep Reset Multivibrator. During the A sweep recovery, Q996A is again returned to conduction and Q996B is turned off (Q984 is already turned on by delayed sweep lockout gate from the A Sweep Generator at the end of the A sweep).

### Delay Multivibrator

The Delay Multivibrator, Q984 and Q986, controls the state of the B Sweep Reset Multivibrator and the Mixed Sweep Blanking Multivibrator. It locks out the B Sweep Generator until it is switched by the Delay-Pickoff Comparator. Transistors Q984 and Q986 are connected as a Schmitt bistable multivibrator. Quiescently, Q984 is held on by the negative level at the collector of Q996A and Q986 remains off. The circuit remains in this condition until the incoming A sweep switches the Delay-Pickoff Comparator (see Delay-Pickoff Comparator discussion). Then the base of Q984 goes positive and it turns off. At the same time, the base of Q986 is pulled negative by the collector level of Q996B and it turns on. The collector of Q984 goes negative and a negative-going output pulse is coupled to the B Sweep Reset Multivibrator stage and the Mixed Sweep Blanking Multivibrator stage through C983.

For Service Manuals Contact  
 MAURITRON TECHNICAL SERVICES  
 8 Cherry Tree Rd, Chinnor  
 Oxon OX9 4QY  
 Tel: 01244-351694 Fax: 01244-352554  
 Email: enquiries@mauritron.co.uk

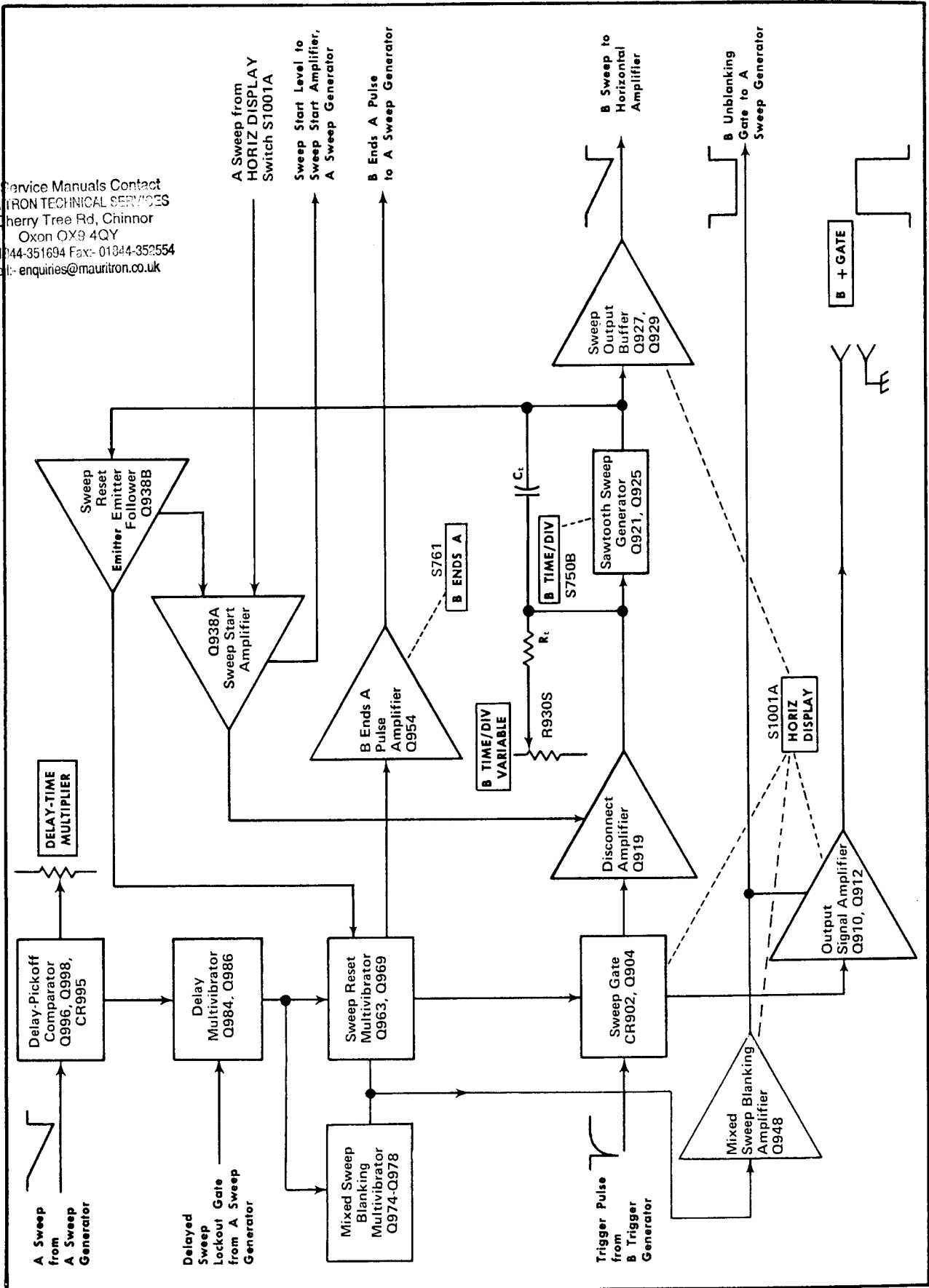

Fig. 3-15. B Sweep Generator detailed block diagram.

This pulse turns Q969 on and Q963 off to enable the B sweep, and also turns Q987 on and Q974 off to provide additional unblanking during the B sweep portion of a MIXED display. Since the B sweep portion of the display will normally be at a faster sweep rate than the A sweep portion, the B sweep portion would appear dimmer without the additional unblanking.

The delayed sweep lockout gate from the Lockout Gate Amplifier stage in the A Sweep Generator circuit is connected to the base of Q984 through R993, CR991 and CR992. This gate goes negative when the A sweep ends, and positive after the A sweep holdoff time. Therefore, Q984 is turned on at the end of the A sweep, and is held on until after the A sweep holdoff time. However, the base of Q984 remains negative due to the current through Q996A, and the B sweep is held locked out until the Delay-Pickoff Comparator stage is switched by the incoming A sweep signal (see Delay-Pickoff Comparator discussion). This configuration allows accurate delayed sweep measurements when the DELAY-TIME MULTIPLIER control is set near 0 by locking out any changes in the quiescent level of the A sawtooth which occur during the A sweep reset and holdoff time. If the B sweep is still running when the A sweep resets, the negative-going portion of the delayed sweep lockout gate connected to Q984 resets the B sweep also.

### Sweep Reset Multivibrator

The basic B Sweep Reset Multivibrator configuration and operation is the same as for A sweep. However, several differences do exist. B sweep does not have a sweep length network for variable sweep length, or a Holdoff Capacitor and associated circuit to reset the B Sweep Reset Multivibrator after the retrace. Instead, the negative-going sweep from the B Sweep Reset Emitter Follower, Q938B, is connected to the base of Q963 through CR967. Diode CR967 is forward biased when the sweep voltage at the emitter of Q938B drops about 0.5 volt more negative than the level at the base of Q963 established by voltage divider R966-R967 between +12 volts and the collector of Q969. Then Q963 turns on and its collector goes positive to switch the B Sweep Gate tunnel diode, CR902, to its low-voltage state which resets the B sweep. Q963 remains on and holds the B Sweep Gate tunnel diode locked out until the B Sweep Reset Multivibrator is reset by the Delay Multivibrator (see Delay Multivibrator discussion).

When the B Sweep Reset Multivibrator is reset by the Delay Multivibrator, Q969 comes on and Q963 turns off. The collector of Q963 goes negative and the B Sweep Gate tunnel diode, CR902, is enabled. The state in which CR902 remains depends upon the B SWEEP MODE switch and the HORIZ DISPLAY switch. When the B SWEEP MODE switch, S835, is set to the TRIGGERABLE AFTER DELAY TIME position, CR902 is biased so it can be switched to its high-voltage state by the next trigger pulse from the B Trigger Generator. However, if the B SWEEP

MODE switch is set to the B STARTS AFTER DELAY TIME position, the setting of the HORIZ DISPLAY switch, S1001A, determines operation of the Sweep Gate tunnel diode. In the A position, the B trigger pulses are blocked in the B Trigger Generator circuit so the B Sweep Generator cannot be triggered and does not produce a sweep (note that the B Sweep Output Buffer, Q929, is also held reverse biased in this position). In the A INTEN DURING B and B (DELAYED SWEEP) positions, -12 volts is connected to the cathode of CR902 through R901, R961 and R962. This voltage pulls the cathode of CR902 negative enough so that it automatically switches to its high-voltage state after it is enabled by the B Sweep Reset Multivibrator. This produces a free-running B sweep similar to the no-trigger AUTO TRIG mode in the A Sweep Generator. However, since the B sweep is reset (and automatically retriggered) at a fixed point on the A sweep sawtooth, the display is relatively stable. The best delayed sweep stability is provided in the TRIGGERABLE AFTER DELAY TIME position, however, since the B sweep is initiated by the trigger signal in this mode.

Note that there is no holdoff circuit in the B Sweep Reset Multivibrator stage. The B Sweep Generator circuit is not reset at the end of the B sweep recovery, but is reset after the end of the A sweep by the Delay Multivibrator (see previous discussion).

### Mixed Sweep Blanking Multivibrator

Transistors Q974 and Q978 comprise a bistable multivibrator very similar in configuration to the Sweep Reset Multivibrator. The purpose of the Mixed Sweep Blanking Multivibrator is to provide additional unblanking during the B sweep portion of a mixed sweep display. Because the B Sweep Generator is normally running at a faster sweep rate than the A Sweep Generator in a mixed sweep display, this additional unblanking reduces the intensity differences between the two parts of the display.

During the A Sweep portion of a mixed sweep display, transistor Q978 is off and Q974 is on. At the end of the delay time, a negative pulse is coupled to the base of Q978 from the collector of Q984 by capacitor C983. Q978 is turned on and its collector goes positive. This positive movement is coupled to the base of Q974 through C977-R977 and turns Q974 off. At the same time that Q978 is turned on, the pulse from C983 also turns Q969 on, and its collector goes positive. The negative movement of the collector of Q974 and the positive movement of the collector of Q969 are added together, so that the net change at the base of Q948 is an approximately 0.6 volt more positive level. The increased conduction of Q948 causes its collector to step slightly more negative to further unblank the CRT display. Then, at the end of the B Sweep time, Q963 turns on and Q969 turns off. The negative movement at the base of Q948 is sufficient to cause total blanking of the CRT and the remaining part of A Sweep is not seen.

### Mixed Sweep Blanking Amplifier

In the MIXED position of the HORIZ DISPLAY switch, +12 volts is applied to the collector of the Mixed Sweep Blanking Amplifier Q948 through collector load resistor R948. The normal B Sweep unblanking signal is blocked because there is no forward bias voltage applied to CR907 and CR908. The output signal from the collector of Q948 is added through CR948 and CR949 to the unblanking signal from the A Sweep Generator and composite blanking is achieved (see Mixed Sweep Blanking Multivibrator discussion).

### B Ends A Pulse Amplifier

The positive-going voltage at the collector of Q963 as the B sweep ends is connected to the B Ends A Amplifier, Q954, through R959 and C959. When the A SWEEP LENGTH control is in the B ENDS A position, this pulse saturates Q954 to produce a negative-going pulse at its collector. This negative-going pulse is connected to the A Sweep Reset Multivibrator stage to reset the A sweep at the end of the B sweep for maximum delayed sweep repetition rate.

### Sweep Start Amplifier

In all positions of the HORIZ DISPLAY switch except MIXED, the operation of the B Sweep Start Amplifier Q938A is the same as described for the A Sweep Start Amplifier stage. In the MIXED position, the Sweep Start control R943 is disconnected from the base of the amplifier and the A Sweep sawtooth is applied. Now, the point at which the B Sweep Generator will start generating its sawtooth waveform is constantly being changed by the A Sweep sawtooth. The output waveform from the B Sweep Generator takes the form of a composite sawtooth waveform with the first and last parts occurring at a rate determined by the A Sweep Generator (last part of composite sweep blanked out) and the middle part occurring at a rate determined by the B Sweep Generator.

### Sweep Output Buffer

In the A, A INTEN DURING B and X-Y positions of the HORIZ DISPLAY switch, -12 volts is connected to the emitter of Q929 through R929 to block the B sweep output signal. In the B (DELAYED SWEEP) and MIXED positions, this stage provides the output sawtooth current to the Horizontal Amplifier circuit. Circuit operation is the same as described for the A Sweep Amplifier stage.

## HORIZONTAL AMPLIFIER

### General

The Horizontal Amplifier circuit provides the output signal to the CRT horizontal deflection plates. In all posi-

tions of the HORIZ DISPLAY switch except X-Y, the horizontal deflection signal is a sawtooth from the A Sweep Generator circuit, the B Sweep Generator circuit, or a composite sawtooth from both. In the X-Y position, the horizontal deflection signal is obtained from the Channel 1 Vertical Preamp through the Trigger Preamp circuit. In addition, this circuit contains the horizontal magnifier circuit and the horizontal positioning network. Fig. 3-16 shows a detailed block diagram of the Horizontal Amplifier circuit. A schematic of this circuit is shown on diagram 11 at the back of this manual.

### Input Paraphase Amplifier

The Input Paraphase Amplifier is a current driven stage with a low input impedance. It converts a single-ended input signal to a push-pull output signal which is necessary to drive the horizontal deflection plates of the CRT. In the A and A INTEN DURING B positions of the HORIZ DISPLAY switch, the sawtooth from the A Sweep Generator circuit is connected to the base of Q1012 through R1005. The B sawtooth is blocked by the HORIZ DISPLAY switch in the B Sweep Generator circuit. In the B (DELAYED SWEEP) position of the HORIZ DISPLAY switch, the B sawtooth is connected to Q1012 and the A sawtooth is blocked in the A Sweep Generator circuit. In the MIXED position of the HORIZ DISPLAY switch, a composite sawtooth waveform derived from the outputs of both the A and B Sweep Generator circuits is connected to the base of Q1012. Whichever sawtooth signal is connected to the Horizontal Amplifier produces a current change at the base of Q1012, which is amplified to produce a positive-going sawtooth voltage at the collector. At the same time, the emitter of Q1012 goes negative and this change is connected to the emitter of Q1016. In all positions of the HORIZ DISPLAY switch except X-Y, the base of Q1016 is grounded so that Q1016 operates as the emitter-driven section of a paraphase amplifier. Then the negative-going change at its emitter is amplified to produce a negative-going sawtooth signal at the collector. Thus the single-ended input signal has been amplified, and is available as a push-pull signal at the collectors of Q1012 and Q1016.

The horizontal POSITION control, R1000A, and FINE control, R1000B, are also connected to the base of Q1012. These controls vary the quiescent DC level at the base of Q1012, which in turn sets the quiescent DC level at the horizontal deflection plates to determine the horizontal position of the trace.

For X-Y operation, the HORIZ DISPLAY switch ungrounds the base of Q1016 and connects the base of Q1012 to ground. This allows the Channel 1 signal from the Trigger Preamp circuit to be connected to Q1016 through R1007 (TRIGGER switch set to CH 1 ONLY OR X-Y). The HORIZ DISPLAY switch connects a voltage level to the Vertical Switching circuit also, to lock the Diode Gate stage in the CH 2 mode (see Vertical Switching discussion).



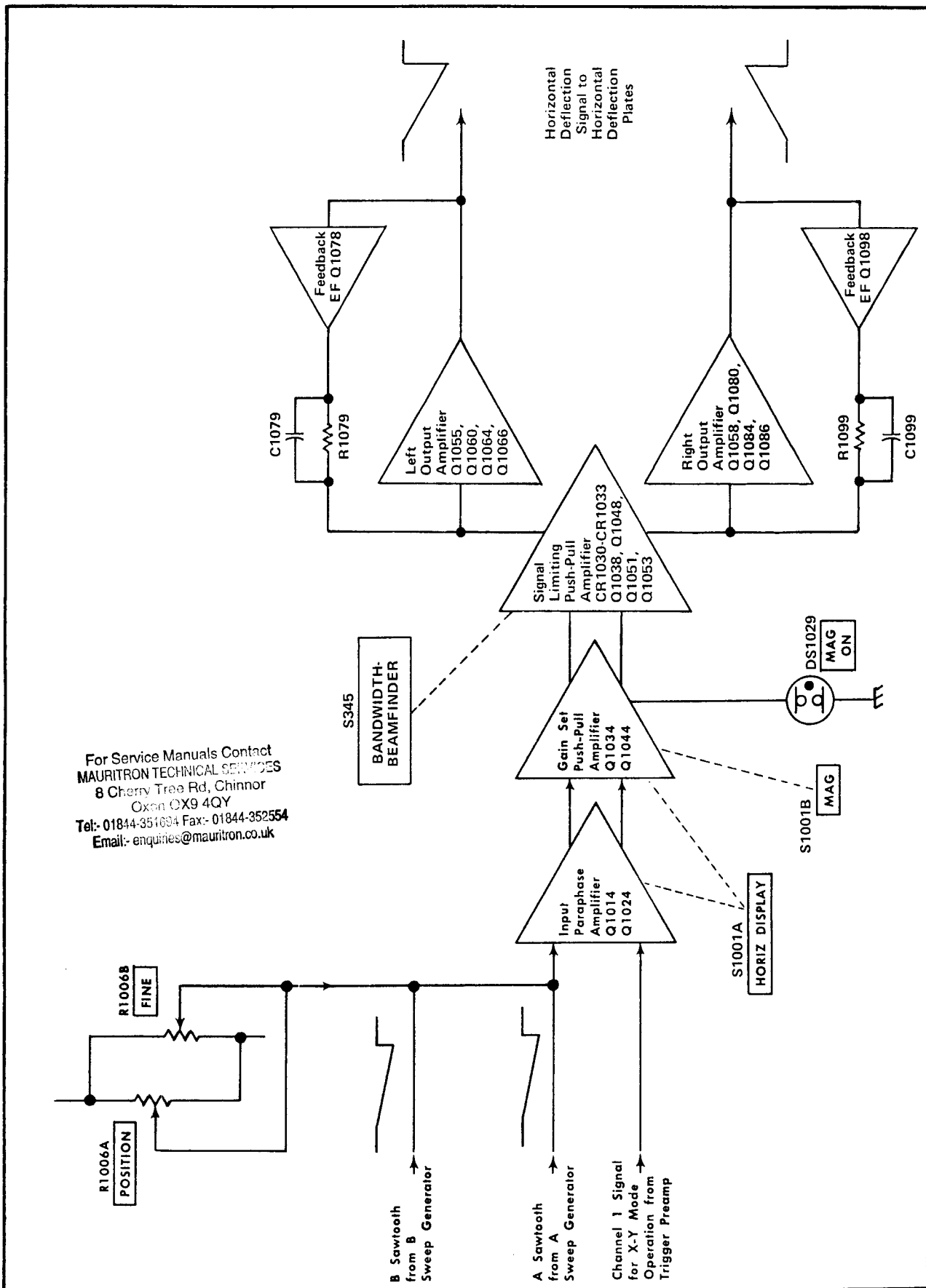

For Service Manuals Contact  
**MAURITRON TECHNICAL SERVICES**  
 8 Cherry Tree Rd, Chinnor  
 Oxon OX9 4QY  
 Tel: 01844-351604 Fax: 01844-352554  
 Email: enquiries@mauritron.co.uk

Fig. 3-16. Horizontal Amplifier detailed block diagram.

Diagram 12 shows a complete diagram of the HORIZ DISPLAY switch. Now, the circuit operates much the same as just described with the sawtooth input. A positive-going signal from Channel 1 produces a current change at the base of Q1016 which increases the current flow through the transistor. The collector of Q1016 goes negative, while the emitter-coupled signal to Q1012 produces a positive-going change at the collector of Q1012. Since the base of Q1012 is grounded, the POSITION and FINE controls are disconnected from the input. The DC level of the Channel 1 signal as determined by the CH 1 POSITION control determines the quiescent DC level at the horizontal deflection plates.

### Gain Set Push-Pull Amplifier

The push-pull output of the Input Paraphase Amplifier is connected to the bases of Q1018 and Q1020. This stage provides adjustment to set the normal and magnified horizontal gain, and a MAG switch to provide a horizontal sweep which is magnified 10 times. For normal sweep (MAG switch set to OFF), R1024 and R1025 control the emitter degeneration between Q1018 and Q1020 to set the gain of the stage. R1024, Normal Gain, is adjusted to provide calibrated horizontal sweep rates. When the MAG switch, S1001B, is set to the X10 position, R1026 and R1027 are connected in parallel with R1024 and R1025 (except in X-Y position of HORIZ DISPLAY switch). This additional resistance decreases the emitter degeneration of this stage and increases the gain 10 times, R1026, Mag Gain, is adjusted to provide calibrated magnified sweep rates. When the MAG switch is set to X10, the MAG ON light, DS1029, is connected to the +150-volt supply through R1029. DS1029 is ignited to indicate that the sweep is magnified. However, in the X-Y position of the HORIZ DISPLAY switch, +12 volts is connected across DS1029 to keep it from igniting. The HORIZ DISPLAY switch also disconnects the MAG switch so the horizontal gain is correct for X-Y operation (horizontal deflection factor indicated by CH 1 VOLTS/DIV switch) regardless of the setting of the MAG switch.

Diodes CR1024 and CR1025 in the emitter circuits of Q1018 and Q1020 respectively, provide limiting to prevent the transistors in this range from going into cutoff or saturation when the sweep is magnified, or the display is positioned to an extreme in either direction. For example, as the base of Q1018 is driven positive by the sweep signal (MAG switch set to X10), the current through R1021 increases until the voltage across CR1024 is too low to keep it forward biased. CR1024 then disconnects R1021 and the emitter coupling network R1024-R1025-R1026-R1027, to leave only R1018 as the emitter resistor for Q1018. Since R1018 adds more resistance in the emitter circuit, the gain of Q1018 is decreased and it also has more dynamic range. Although this produces distortion in the signal at the collector of Q1018, it occurs in the portion of the sawtooth which is not displayed on the CRT. This arrangement pro-

vides a faster recovery time for Q1018 and Q1020 to improve operation at fast sweep rates.

### Signal Limiting Push-Pull Amplifier

Q1038 and Q1048 comprise a normal push-pull amplifier. Diodes CR1030, CR1031, CR1032 and CR1033 limit the signal difference between the bases of Q1038 and Q1048 to about 1.2 volts to prevent this stage from being overdriven. Q1051 and Q1053 in the collector circuits are transistors connected as diodes, which limit the maximum flow of current to the base terminals of Q1060 and Q1080 to about 15 milliamperes and prevent overdrive of the output stages.

The Mag Register adjustment, R1031, balances the quiescent DC current to the base of Q1038 and Q1048 so a center-screen display does not change position when the MAG switch is changed from X10 to OFF.

The BANDWIDTH-BEAM FINDER switch, S345, reduces horizontal scan by reducing the gain of the Signal Limiting Push-Pull Amplifier stage. Normally the emitters of Q1038 and Q1048 are returned to +12 volts through R1044 and R1046. However, when the BANDWIDTH-BEAM FINDER switch is pressed down to the BEAM FINDER position, resistor R1045 is added in series between resistors R1044-R1046 and +12 volts. This limits the output swing of the Horizontal Amplifier to limit the trace within the graticule area.

### Output Amplifier

The push-pull output of the Signal Limiting Push-Pull Amplifier stage is connected to the Output Amplifier through the current limiting transistors Q1051 and Q1053. Each half of the Output Amplifier can be considered as a single-ended feedback amplifier which amplifies the signal current at the input to produce a voltage output to drive the horizontal deflection plates of the CRT. The amplifiers have a low input impedance and require very little voltage change at the input to produce the desired output change. Transistors Q1060 and Q1080 are inverting amplifiers whose collector signals drive the emitters of complimentary amplifiers Q1064-Q1066 and Q1084-Q1086 respectively. Transistors Q1078 and Q1098 are emitter followers in the negative-feedback paths that reduce loading on the output of the amplifier, thereby improving the overall amplifier frequency response. The output signal from complimentary amplifier Q1064-Q1066 drives the left horizontal deflection plate of the CRT, and the output signal from complimentary amplifier Q1084-Q1086 drives the right horizontal deflection plate. C1074, C1094, C1095 and R1095 adjust the transient response of the amplifier so it has good linearity at fast sweep rates.

## LOW-VOLTAGE POWER SUPPLY

### General

The Low-Voltage Power Supply circuit provides the operating power for this instrument from three regulated supplies and one unregulated supply. Electronic regulation is used to provide stable, low-ripple output voltages. Each regulated supply contains a short-protection circuit to prevent instrument damage if a supply is inadvertently shorted to ground. The Power Input stage includes the Voltage Selector Assembly. This assembly allows selection of the nominal operating voltage and regulating range for the instrument. Fig. 3-17 shows a detailed block diagram of the Power Supply circuit. A schematic of this circuit is shown on diagram 13 at the back of this manual.

### Power Input

Power is applied to the primary of transformer T1101 through the 115-volt line fuse F1101, POWER switch S1101, thermal cutout TK1101, Voltage Selector switch S1102 and Range Selector switch S1103. Voltage Selector switch S1102 connects the split primaries of T1101 in parallel for 115-volt nominal operation, or in series for 230-volt nominal operation. A second line fuse, F1102, is connected into the circuit when the Voltage Selector switch is set to the 230 V position to provide the correct protection for 230-V operation (F1102 current rating is one-half of F1101).

The Range Selector switch, S1103, allows the instrument to regulate correctly on higher or lower than normal line voltages. Each half of the primary has taps above and below the 115-volt (230) nominal point. As the Range Selector switch, S1103, is switched from LO to M to HI, more turns are effectively added to the primary winding and the turns ratio is decreased. This maintains a nearly constant voltage in the secondary of T1101, even through the primary voltage has increased.

Thermal cutout TK1101 provides thermal protection for this instrument. If the internal temperature of the instrument exceeds a safe operating level, TK1101 opens to interrupt the applied power. When the temperature returns to a safe level, TK1101 automatically closes to re-apply the power.

### −12 Volt Supply

The −12-Volt Supply provides the reference voltage for the remaining supplies. The output from the secondary of T1101 is rectified by bridge rectifier CR1112A-D. This voltage is filtered by C1112-R1112 and then applied to the −12-Volt Series Regulator stage to provide a stable output voltage. The Series Regulator can be compared to a variable resistance which is changed to control the output current.

The current through the Series Regulator stage is controlled by the Error Amplifier to provide the correct regulated output voltage.

The Error Amplifier is connected as a comparator. Reference voltage for the comparator is provided by zener diode VR1116, which sets the base of Q1116 at about −9 volts. The base level of Q1124 is determined by voltage divider R1123-R1124-R1125 between the output of this supply and ground. R1124 is adjustable to set the output voltage of this supply to −12 volts. R1120 is the emitter resistor for both comparator transistors, and the current through it divides between Q1116 and Q1124. The output current of the Error Amplifier stage controls the conduction of the Series Regulator stage (through Q1133). This output current is changed to provide a constant, low-ripple −12-volt output level. This occurs as follows: The comparator action of Q1116 and Q1124 attempts to maintain equal voltages at the bases of both transistors. If the −12 Volts adjustment, R1124, is turned clockwise, the current through Q1124 increases (Q1124 base tends to go more positive than the base of Q1116), and the current through Q1116 decreases. Decreased current through Q1116 produces less voltage drop across R1118, and the base of Q1133 goes positive. The emitter of Q1133 pulls the base of Q1137 positive to increase the current through the load, thereby increasing the output voltage of the supply. This places more voltage across divider R1123-R1124-R1125 and the divider action returns the base of Q1124 to about −9 volts. A similar, but opposite, action takes place when R1124 is turned counterclockwise so the base of Q1124 is more negative than the base of Q1116. The −12 Volts adjustment, R1124, is set to provide a −12-volt level at the output of this supply.

The output voltage is regulated to provide a constant voltage to the load by feeding a sample of the output back to the Series Regulator, Q1137. For example, assume that the output voltage increases (more negative) because of a change in load or an increase in line voltage. This negative-going level at the output is applied across the voltage divider R1123-R1124-R1125 and the base of Q1124 goes negative also. This reduces the current flow through Q1124, which allows Q1116 to conduct more and its collector goes negative. When the collector of Q1116 goes negative, the bias on Q1133 is reduced, resulting in reduced current through the Series Regulator, Q1137. Reduced current through Q1137 also means that there is less current through the load and the output voltage decreases (less negative). In a similar manner, the Series Regulator and Error Amplifier stages compensate for output changes due to ripple.

The Short-Protection Amplifier stage, Q1119, protects the −12-Volt Supply if the output is shorted. For normal operation the emitter-base voltage of Q1119 is not enough to bias it on. However, when the output is shorted, high

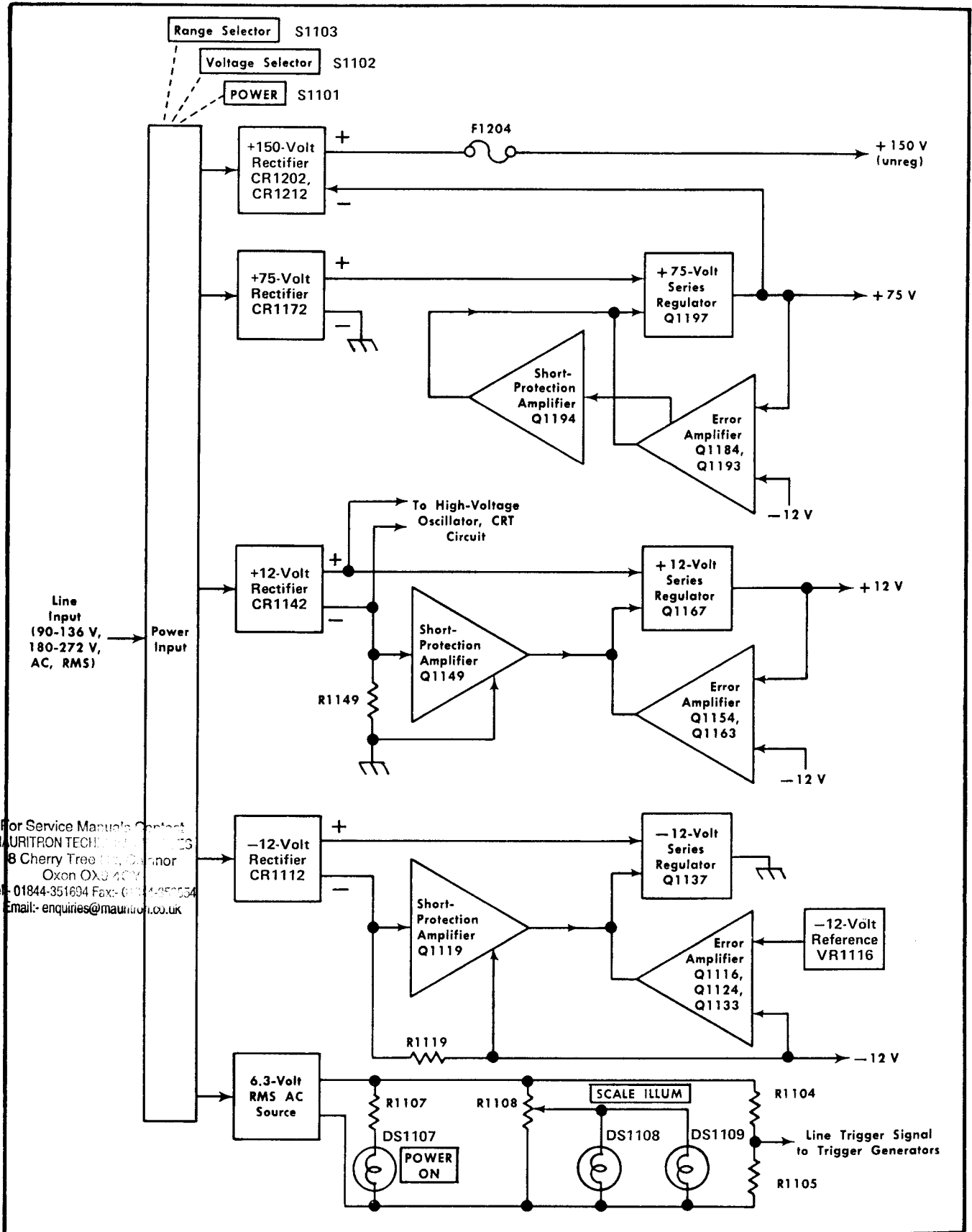

For Service Manuals Contact  
 MAURITRON TECHNICAL SERVICES  
 8 Cherry Tree Lane, Cumnor  
 Oxon OX3 4CY  
 Tel: 01844-351694 Fax: 01844-950554  
 Email: enquiries@mauritron.co.uk

Fig. 3-17. Power Supply detailed block diagram.

current is demanded from the Series Regulator, Q1137, and this current flows through R1119. The voltage drop across R1119 becomes sufficient to forward bias Q1119 and its collector current produces an increased voltage drop across R1118. The increased voltage drop across R1118 reduces the current flow of both Q1133 and Q1137 to limit the output current. CR1125 protects this circuit from damage if its output is shorted to one of the positive supplies.

This instrument is designed so that all power is interrupted if any one of the supplies is shorted to ground. CR1120 reduces the -12-Volt Supply output if the +12-volts output is shorted. Since the operating level for Q1116 and Q1133 is obtained from the +75-volt output through R1118, the -12-Volt Supply is shut off if the +75-volt output is shorted. Likewise, since both the +75-Volt Supply and the +12-Volt Supply are referenced to the -12-volt output, these supplies are shut off if the -12-volt output is shorted.

### +12-Volt Supply

Rectified voltage for operation of the +12-Volt Supply is provided by CR1142A-D. This voltage is filtered by C1142-R1142 and connected to the +12-Volt Series Regulator and to the High-Voltage Oscillator stage in the CRT Circuit. Reference voltage for this supply is provided by voltage divider R1157-R1158-R1159 between the regulated -12 volts and the output of this supply. The -12 volts is held stable by the -12-Volt Supply as discussed previously. If the +12-volt output changes, this change appears at the base of Q1154 as an error signal. Regulation of the output voltage is controlled by the +12-Volt Series Regulator stage, Q1167, in a similar manner to that described for the -12-Volt Supply. The +12-Volts adjustment, R1158, sets the output level to +12 volts. CR1158 and CR1159 provide thermal compensation for the Error Amplifier. C1155-R1155 improve response of the regulator circuit to low-frequency changes at the output.

Shorting protection is provided by Q1149 and R1149. If the output of this supply is shorted, Q1149 is biased on to limit the conduction of the Series Regulator in the same manner as described for the -12-Volt Short-Protection Amplifier. CR1154 protects Q1154 when the output of this supply is shorted.

### +75-Volt Supply

CR1172A-D provides the rectified voltage for the +75-Volt Supply. C1172 and R1172 filter the rectified voltage, which is connected to the +75-Volt Series Regulator. Reference voltage for this supply is provided by voltage divider R1187-R1188-R1189 between the regulated -12 volts and the output of this supply. Since the -12 volts is held stable by the -12 Volt Regulator circuit, any change at the base of Error Amplifier Q1184 is due to a change at

the output of the +75-Volt Supply. Regulation of the output voltage is controlled by Error Amplifier Q1184-Q1193 and Series Regulator, Q1197, in a manner similar to that described for the -12-Volt Supply. The +75 Volts adjustment, R1188, sets the quiescent conduction level of the Error Amplifier stage to provide an output level of +75 volts. The output of the +150-Volt Supply (unregulated) is connected to the Error Amplifier to provide the required collector level for stable operation. Zener diode VR1190 sets the collector of Q1193 at about +80 volts and zener diode VR1182 establishes a level of about +105 volts at the junction of R1182-R1183. Then, R1183, zener diode VR1184 and R1184 drop this voltage to the correct level for the operation of Q1184. CR1189 provides thermal compensation for the Error Amplifier.

Q1194 protects this supply if the output is shorted to ground. If this occurs, excess current is demanded from the Series Regulator, Q1197, and this additional current through R1197 raises the emitter of Q1197 more positive. This produces a corresponding change at the base of Q1197, which is connected to Q1194 through divider R1193-R1194. Under normal conditions, this divider sets the base level of Q1194 so Q1194 is about zero biased. However, when the output is shorted, the positive-going change across the divider R1193-R1194 raises the base level of Q1194 positive and it is forward biased. When Q1194 comes on, its collector goes negative and it turns Q1193 off to reduce the current flow through the Series Regulator stage, Q1197, and the output voltage drops toward ground. The output current also decreases and remains low until the excessive load is removed. CR1193 protects Q1193 and CR1185 protects Q1184 from excess reverse voltage when the output is shorted. CR1196 protects the +75-Volt Supply from damage if it is shorted to the -12 volt supply.

### +150-Volt Unregulated Supply

Rectifiers CR1202 and CR1212 provide the unregulated output for the +150-volt Supply. Taps from this secondary winding also provide the necessary operating potential for the cooling fan motor. The output of the +75-Volt Supply is connected to the negative side of the +150-Volt Supply to elevate the output level to +150 volts. Diodes CR1202 and CR1212 are connected as a full-wave center-tapped rectifier, and the output is filtered by C1202-C1204-R1202-R1204 to hold the output level at about +150 volts. Fuse F1204 protects this supply if the output is shorted.

### 6.3-Volt RMS AC Source

The 6.3-volt RMS secondary winding of T1101 provides power for the POWER ON light, DS1107, and the scale illumination lights DS1108 and DS1109. The current through the scale illumination lights is controlled by the SCALE ILLUM control, R1108, to change the illumination of the graticule lines. Voltage divider R1104-R1105 pro-

vides a sample of the line voltage to the A and B Trigger Generator circuits for internal triggering at the line frequency.

### VOLTAGE DISTRIBUTION

Diagram 14 shows the distribution of the output voltages from the Power Supply circuit to the circuit boards in this instrument. The decoupling networks which provide decoupled operating voltages are shown on this Diagram and are not repeated on the individual circuit diagrams.

## CALIBRATOR

### General

The Calibrator circuit produces a square-wave output with accurate amplitude and frequency. This output is available as a square-wave voltage at the 1 V CAL 1 kHz connector and as a square-wave current through the CURRENT PROBE CAL loop. Fig. 3-18 shows a detailed block diagram of the Calibrator circuit. A schematic of this circuit is shown on diagram 15 at the back of this manual.

### Oscillator

Q1275 and its associated circuitry comprises a tuned-collector oscillator. Frequency of oscillation is determined by the LC circuit made up of the primary of variable transformer T1275 in parallel with C1275. The accuracy and stability required to provide an accurate time and frequency reference is obtained by using a capacitor and transformer which have opposite temperature coefficients.

The oscillations of the LC circuit, T1275-C1275, are sustained by the feedback winding of T1275 connected to the base of Q1275. C1286 connects a sample of the output from the LC circuit to the base of Q1285. The regenerative feedback from the emitter of Q1285 to the emitter of Q1275 produces fast change-over between Q1275 and Q1285 to provide a fast risetime on the output square wave. Frequency of the output square wave can be adjusted by varying the inductance of the primary winding of T1275 slightly. The square-wave signal at the collector of Q1285 is connected to the Output Amplifier.

### Output Amplifier

The output signal from the oscillator stage overdrives Q1294 to produce the accurate square wave at the output. When the base of Q1294 goes positive, Q1294 is cut off and the output signal drops negative to ground. When the base goes negative, Q1294 is driven into saturation and the output signal rises positive to about +12 volts. The collector current of Q1294 flows through R1296, R1298 and the CURRENT PROBE CAL loop on the side panel. Current through the CURRENT PROBE CAL loop is a five-milliampere square wave. The output voltage is connected from the divider R1296-R1298 to the 1 V CAL 1 kHz connector through R1299. The output of the +12-Volt Supply is adjusted for an accurate one-volt output signal at the 1 V CAL 1 kHz connector.

## Z AXIS AMPLIFIER

### General

The Z Axis Amplifier circuit controls the CRT intensity level from several inputs. The effect of these input signals is

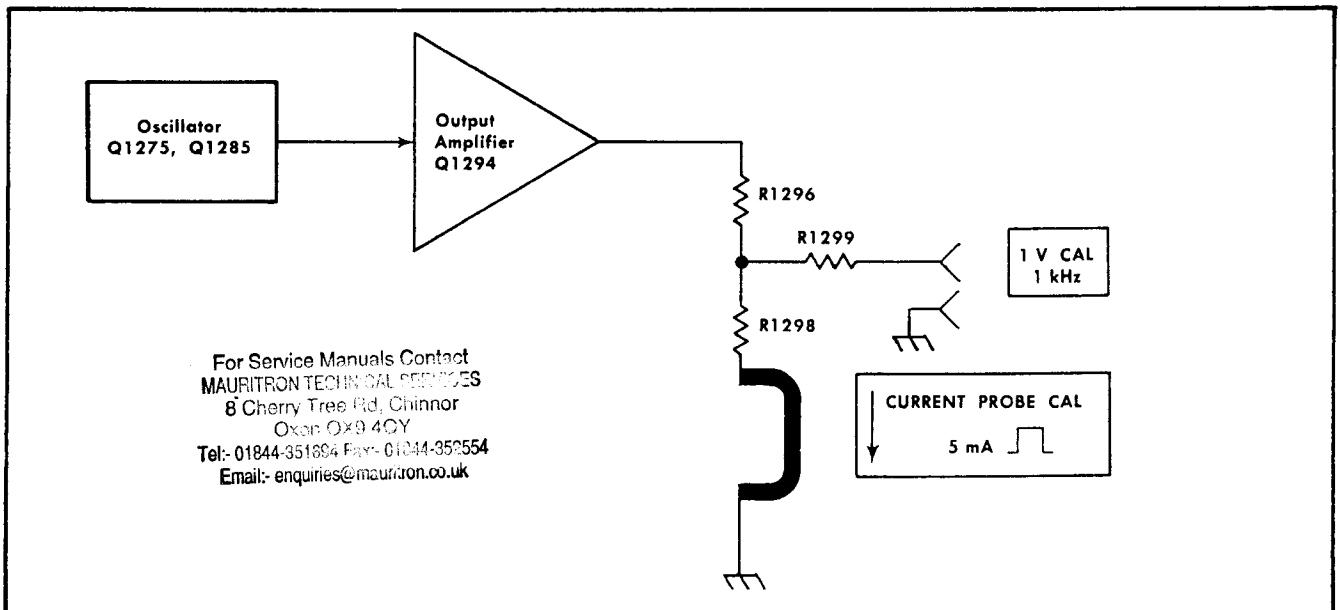

Fig. 3-18. Calibrator detailed block diagram.

to either increase or decrease the trace intensity, or to completely blank portions of the display. Fig. 3-19 shows a detailed block diagram of the Z Axis Amplifier circuit. A schematic of this circuit is shown on diagram 16 at the back of this manual.

The input transistor, Q1314, in the Input Amplifier stage is a current-driven, low input impedance amplifier. It provides termination for the input signals as well as isolation between the input signals and the following stages. The current signals from the various control sources are connected to the emitter of Q1314 and the sum or difference of the signals determines the collector conduction level. CR1314 and CR1318 in the collector provide limiting protection at minimum intensity. When the INTENSITY control is set fully counterclockwise (minimum), the collector current of Q1314 is reduced, and its collector rises positive. CR1318 is reverse biased to block the control current at the base of Q1323, and CR1314 is forward biased to protect the circuit by clamping the collector of Q1314 about 0.5 volt more positive than the emitter level of Q1323. This limiting action also takes place when a blanking signal is applied. The clamping action of CR1314 allows Q1314 to recover faster to produce a sharper display with sudden changes in blanking level. At normal intensity levels, CR1314 is reverse biased and the signal from Q1314 is coupled to emitter follower Q1323 through CR1318.

The input signals vary the current drive to the emitter of Q1314, which produces a collector level that determines the brilliance of the display. The INTENSITY control sets the quiescent level at the emitter of Q1314. When R1301 is turned in the clockwise direction, more current from the INTENSITY control is added to the emitter circuit of Q1314, which results in an increase in collector current to provide a brighter trace. However, the vertical chopped blanking, Z axis input and A and B unblanking signals determine whether the trace is visible with a given INTENSITY control setting (not at maximum). The vertical chopped blanking signal blanks the trace during dual-trace switching. This signal decreases the current through Q1314 during the trace switching time to blank the CRT display. The external blanking input allows an external signal connected to the Z AXIS INPUT connector to change the trace intensity. A positive-going signal connected to the Z AXIS INPUT connector decreases trace intensity and a negative-going signal increases trace intensity. The A and B unblanking signal from the A Sweep Generator circuit blanks the CRT during sweep retrace and recovery time so there is no display on the screen. When the A and/or B Sweep Generator circuits are reset and recovered (see A and B Sweep Generator discussions for more information), the next trigger pulse initiates the sweep and an unblanking signal is generated in the A or B Sweep Generator circuit that goes negative to allow the emitter current of Q1314 to reach the level established by the INTENSITY control and the other blanking inputs.

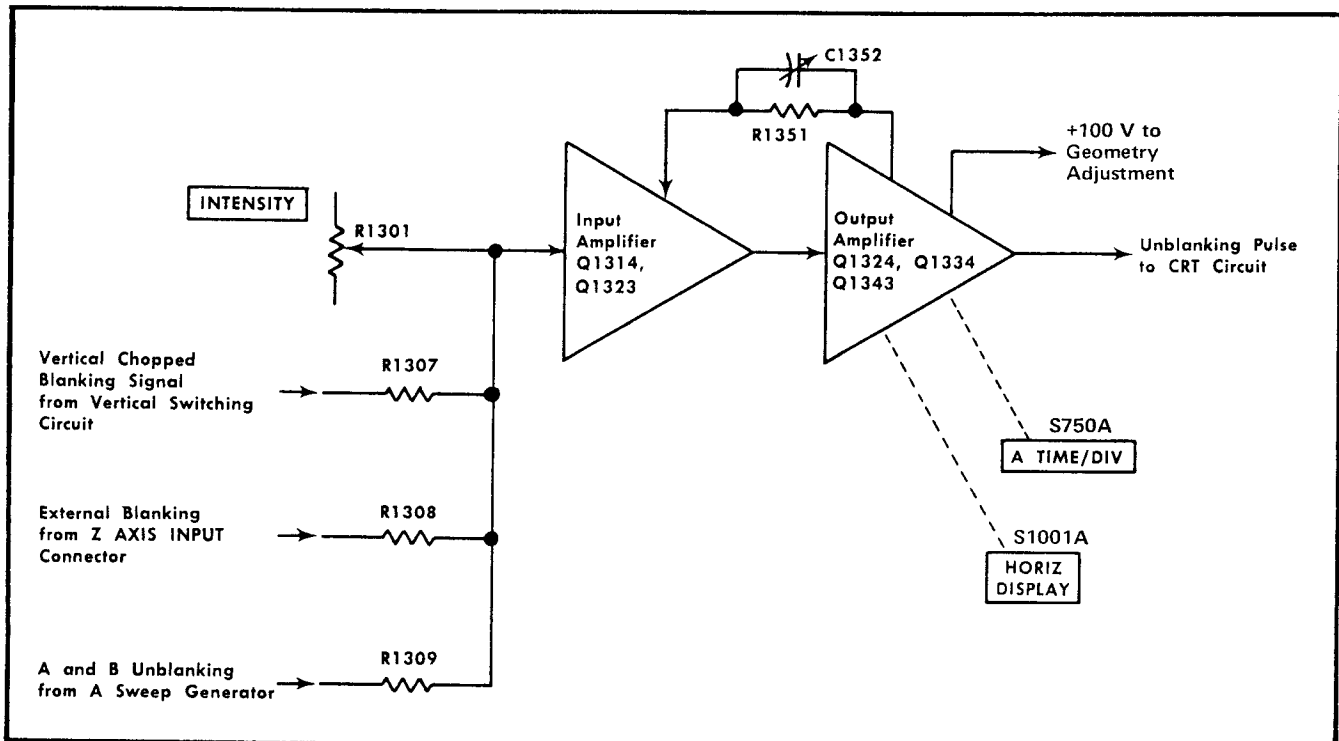

Fig. 3-19. Z Axis Amplifier detailed block diagram.

## Output Amplifier

The resultant signal produced from the various inputs by the Input Amplifier stage is connected to the base of Q1324 through C1324, and the base of Q1334 through R1330. These transistors are connected as a collector-coupled complementary amplifier. This configuration provides a linear, fast output signal with minimum quiescent power.

The overall Z Axis Amplifier circuit is a shunt-feedback operational amplifier with feedback connected from the Output Amplifier stage to the Input Amplifier stage through C1351-C1352-R1351. The output voltage is determined by the input current  $X$  the feedback resistor and is shown by the formula:  $E_{out} = i_{in} \times R_{FB}$  where R1351 is  $R_{FB}$ . The A and B unblanking input current change is approximately two milliamperes. Therefore, the maximum output voltage change is about 60 volts (2 mA  $\times$  30.1 k $\Omega$ ). C1352 adjusts the feedback circuit for optimum step response, so the unblanking gate signal at the output of this circuit has a fast rise with minimum overshoot or ringing. Overshoot or ringing on the unblanking gate would produce a display with uneven intensity immediately following sudden changes in blanking level.

The emitter voltage for Q1324 is changed by the HORIZ DISPLAY switch, S1001A, and the A TIME/DIV switch, S750A, to prevent phosphor burning. When the HORIZ DISPLAY switch is set to B (DELAYED SWEEP) or X-Y, +150 volts is connected to the emitter of Q1324 through CR1326-R1326-R1327. CR1353 is reverse biased and the +75 volts at its anode is disconnected from the circuit. However, in the A, A INTEN DURING B and MIXED positions of the HORIZ DISPLAY switch, the emitter source for Q1324 is determined by the A TIME/DIV switch. In the .1 s to 5 s positions of the A TIME/DIV switch, the emitter of Q1324 is returned to +75 volts through CR1326-R1326-R1327 and CR1353. This less positive emitter source for Q1324 limits the collector level of Q1324 and Q1334 to about +75 volts to protect the CRT phosphor in these switch positions. In the .02  $\mu$ s to 50 ms positions, the emitter source for Q1324 is +150 volts. Operation is the same as in the B (DELAYED SWEEP) and X-Y positions of the HORIZ DISPLAY switch.

Zener diode VR1356 connected between +75 volts and +150 volts through CR1357-R1357-R1358 produces a +100-volt level at the cathode of VR1356. This voltage establishes the correct operating level for the Geometry adjustment in the CRT Circuit and establishes the correct collector level for Q1343. CR1343, connected from base to emitter of Q1343, improves the response of Q1343 to negative-going signals. When the base of Q1343 is driven negative to cutoff, CR1343 is forward biased and conducts the negative-going portion of the unblanking signal. This provides a fast falling edge on the unblanking gate to

quickly turn the display off. The output unblanking gate at the emitter of Q1343 is connected to the CRT circuit through R1344.

## CRT CIRCUIT

### General

The CRT Circuit provides the high-voltage and control circuits necessary for operation of the cathode-ray tube (CRT). Fig. 3-20 shows a detailed block diagram of the CRT Circuit. A schematic of this circuit is shown on diagram 17 at the back of this manual.

### High-Voltage Oscillator

Q1430 and associated circuitry comprise a class C oscillator to produce the drive for the high-voltage transformer, T1430. When the instrument is turned on, the current through R1425 charges C1419 positive, and Q1430 is forward biased. The collector current of Q1430 increases and a voltage is developed across the collector winding of T1430. This produces a corresponding current increase in the feedback winding of T1430 which is connected to the base of Q1430, and this feedback current increases the voltage level at the base of Q1430. When C1419 is fully charged, the base current of Q1430 stabilizes and there is no changing current in the collector winding of T1430. Since there is no change in current through the collector winding, there is no feedback voltage to the base, and the collector current of Q1430 begins to decrease. This produces a current in the feedback winding of T1430 and a corresponding negative voltage (less positive) at the base of Q1430 which begins to turn it off. C1419 slowly discharges to the negative potential on the base of Q1430. Once again, the current flow through the collector winding ceases and there is no feedback to the base of Q1430. Then C1419 begins to recharge through R1425, and the base level of Q1430 rises positive until it is forward biased. Q1430 returns to conduction and another cycle begins. The signal produced across T1430 is a sine wave with a frequency of 40 to 50 kilohertz. The amplitude of the oscillations at the collector of Q1430 is controlled by the High-Voltage Regulator stage.

Fuse F1437 protects the +12-Volt Supply if the High-Voltage Oscillator stage is shorted. Filter network L1437-C1437 prevents current changes in this stage from affecting the +12-volt regulator circuit.

### High-Voltage Regulator

Feedback from the secondary of T1430 is connected to the base of Q1414 through the voltage divider network R1405-R1412. This sample of the output voltage is amplified by Q1414 and Q1413, and applied to the base of Q1423. Amplitude of the oscillations at the collector of Q1430 is determined by the average DC level at the emitter of Q1423.



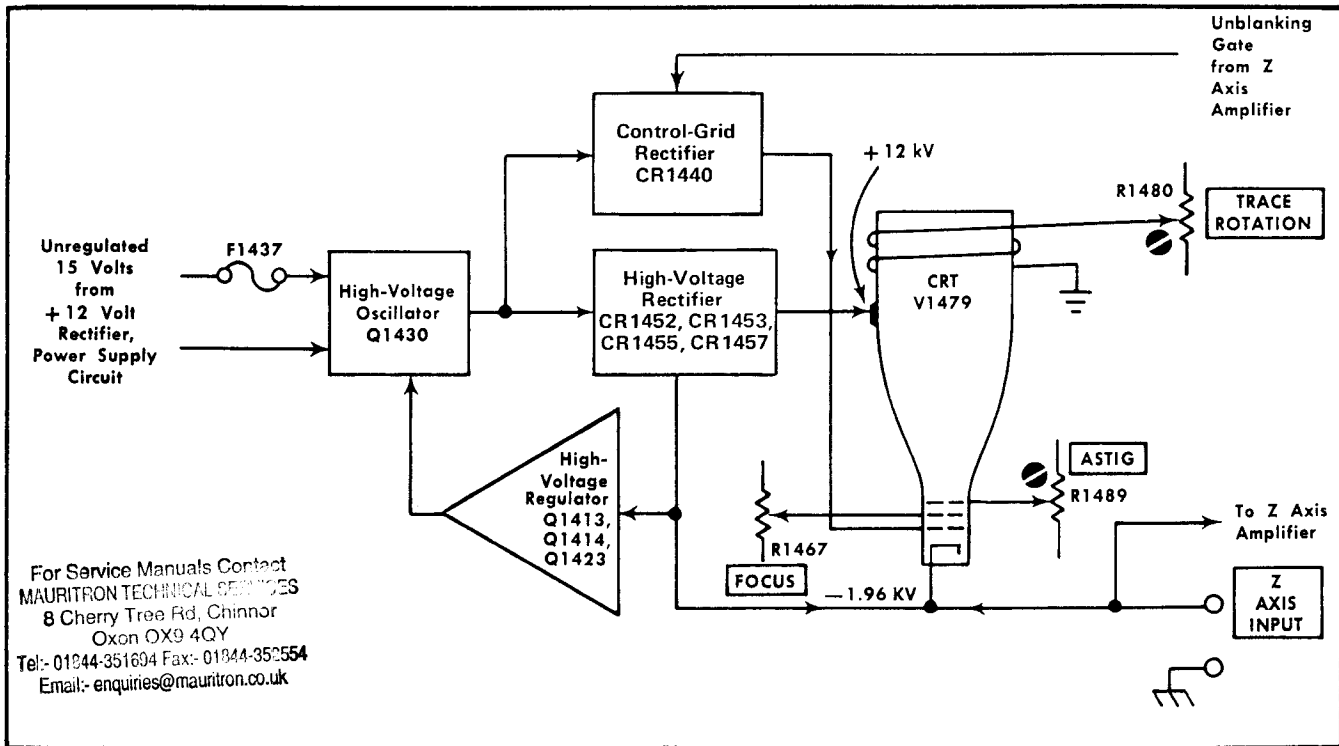

Fig. 3-20. CRT Circuit detailed block diagram.

Regulation takes place as follows: If the output voltage at the  $-1960\text{ V}$  test point starts to go positive (less negative), a sample of this positive-going voltage is applied to the base of Q1414. Q1414 is forward biased and it, in turn, forward biases Q1413 to increase the conduction of Q1423. An increase in current through Q1323 raises the average voltage level at its emitter, which is connected to the base of Q1430, through the feedback winding of T1430. A more positive level at the base of Q1430 increases its collector current to produce a larger induced voltage in the secondary of T1430. This increased voltage appears as a more negative voltage level at the  $-1960\text{ V}$  test point to correct the original positive-going change. By sampling the output from the negative high-voltage rectifier in this manner, the total output of the high-voltage supply is held constant.

Output voltage level of the high-voltage supply is set by the High Voltage adjustment, R1401, in the base circuit of Q1414. This adjustment sets the conduction level of Q1414 which controls the quiescent conduction of Q1413, Q1423 and Q1430 similar to the manner just described for regulation.

### High-Voltage Rectifiers

The high-voltage transformer, T1430, has three output windings. One of the windings provides filament voltage (elevated to CRT cathode potential) for the cathode-ray

tube. The filament voltage can be obtained from the high-voltage supply, since the CRT has a very low filament-current drain. Two high-voltage windings provide the negative and positive accelerating voltage, and the CRT grid bias voltage. All of these outputs are regulated by the High-Voltage Regulator stage in the primary of T1430 to maintain a constant output voltage.

Positive accelerating potential for the CRT anode is supplied by voltage tripler CR1453-CR1455-CR1457. This rectified voltage is filtered by the network C1460-R1460-R1461 to provide a constant output of about +12 kilovolts.

The negative accelerating potential for the CRT cathode is supplied by the half-wave rectifier CR1452. Voltage output is about  $-1.96$  kilovolts. A sample of this output voltage is connected to the High-Voltage Regulator stage to provide a regulated high-voltage output.

The half-wave rectifier CR1440 provides a negative voltage for the control grid of the CRT. Output level is adjustable by the CRT Grid Bias adjustment, R1447. The neon bulbs, DS1473-DS1474-DS1475, provide protection for the CRT Circuit if the voltage difference between the control grid and the CRT cathode exceeds about 165 volts. The unblanking gate from the Z Axis Amplifier circuit is con-

## Circuit Description—454A/R454A

nected to the positive side of this circuit to produce a change in output voltage to control CRT intensity, unblanking, dual-trace blanking and intensity modulation.

### CRT Control Circuits

Focus of the CRT display is controlled by the FOCUS control, R1467. The divider R1463-R1469 is connected between the CRT cathode supply and ground. The voltage applied to the focus grid is more positive (less negative) than the voltage on either the control grid or the CRT cathode. The ASTIG adjustment, R1489, which is used in conjunction with the FOCUS control to provide a well-defined display, varies the positive level on the astigmatism grid.

The Geometry adjustment, R1482, varies the positive level on the horizontal deflection plate shields to control the overall geometry of the display. The +100-volt source for this control is provided by zener diode VR1356 in the Z Axis Amplifier circuit.

Two adjustments control the trace alignment by varying the magnetic field around the CRT. The Y Axis Align adjustment, R1485, controls the current through L1485 which affects the CRT beam after vertical deflection, but before horizontal deflection. The TRACE ROTATION adjustment, R1480 controls the current through L1480 and affects both vertical and horizontal rotation of the beam.

### External Z Axis Input

A signal applied to the Z AXIS INPUT connector is applied to the CRT cathode through C1479-R1477-C1477 and to the Z Axis Amplifier circuit. Low frequency Z-axis signals are prevented from directly affecting the CRT circuit by C1477. They are connected to the Z Axis Amplifier circuit to produce an increase or decrease in intensity, depending upon polarity. C1477 couples high-frequency signals to the CRT cathode to produce the same resultant display as the Z Axis Amplifier circuit produces for low-frequency intensity-modulation signals. This configuration operates as a crossover network to provide nearly constant intensity modulation from DC to 50 megahertz.

For Service Manuals Contact  
MAURITRON TECHNICAL SERVICES  
8 Cherry Tree Rd, Chinnor  
Oxon OX9 4QY  
Tel:- 01844-351694 Fax:- 01844-352554  
Email:- enquiries@mauritron.co.uk

# SECTION 4

## MAINTENANCE

*Change information, if any, affecting this section will be found at the rear of the manual.*

### Introduction

This section of the manual contains maintenance information for use in preventive maintenance, corrective maintenance or troubleshooting of the 454A.

### Cover Removal

The top and bottom covers of the instrument are held in place by thumb screws located on each side of the instrument. To remove the covers, loosen the thumb screws and slide the covers off the instrument. The covers protect the instrument from dust in the interior. The covers also direct the flow of cooling air and reduce the EMI radiation from the instrument.

## PREVENTIVE MAINTENANCE

### General

Preventive maintenance consists of cleaning, visual inspection, lubrication, etc. Preventive maintenance performed on a regular basis may prevent instrument breakdown and will improve the reliability of this instrument. The severity of the environment to which the 454A is subjected determines the frequency of maintenance. A convenient time to perform preventive maintenance is preceding recalibration of the instrument.

### Cleaning

The 454A should be cleaned as often as operating conditions require. Accumulation of dirt in the instrument can cause overheating and component breakdown. Dirt on components acts as an insulating blanket and prevents efficient heat dissipation. It also provides an electrical conduction path.



*Avoid the use of chemical cleaning agents which might damage the plastics used in this instrument. Avoid chemicals which contain benzene, toluene, xylene, acetone or similar solvents.*

The top and bottom covers provide protection against dust in the interior of the instrument. Operation without

the covers in place necessitates more frequent cleaning. The front cover provides dust protection for the front panel and the CRT face. The front cover should be installed for storage or transportation.

**Air Filter.** The air filter should be visually checked every few weeks and cleaned or replaced if dirty. More frequent inspections are required under severe operating conditions. If the filter is to be replaced, order new air filters from your local Tektronix Field Office or representative; order by Tektronix Part No. 378-0033-00. The following procedure is suggested for cleaning the filter.

1. Remove the filter by pulling it out of the retaining frame on the rear panel. Be careful not to drop any of the accumulated dirt into the instrument.
2. Flush the loose dirt from the filter with a stream of hot water.
3. Place the filter in a solution of mild detergent and hot water and let it soak for several minutes.
4. Squeeze the filter to wash out any dirt which remains.
5. Rinse the filter in clear water and allow it to dry.
6. Coat the dry filter with an air-filter adhesive (available from air conditioner suppliers or order Tektronix Part No. 006-0580-00).
7. Let the adhesive dry thoroughly.
8. Re-install the filter in the retaining frame.

**Exterior.** Loose dust accumulated on the outside of the 454A can be removed with a soft cloth or small paint brush. The paint brush is particularly useful for dislodging dirt on and around the front-panel controls. Dirt which remains can be removed with a soft cloth dampened in a mild detergent and water solution. Abrasive cleaners should not be used.

**CRT.** Clean the plastic light filter and the CRT face only with a soft, lint-free cloth dampened with a mild detergent and water solution. The CRT mesh filter can be cleaned in the following manner.

1. Hold the filter in a vertical position and brush lightly with a soft #7 water-color brush to remove light coatings of dust or lint.

2. Greasy residues or dried-on dirt can be removed with a solution of warm water and a neutral-PH liquid detergent. Use the brush to lightly scrub the filter.

3. Rinse the filter thoroughly in clean water and allow it to air dry.

4. If the lint or dirt remains, use clean low-pressure air to remove. Do not use tweezers or other hard cleaning tools on the filter, as the special finish may be damaged.

5. When not in use, store the mesh filter in a lint-free, dust-proof container such as a plastic bag.

**Interior.** Dust in the interior of the instrument should be removed occasionally due to its electrical conductivity under high-humidity conditions. The best way to clean the interior is to blow off the accumulated dust with dry, low-velocity air. Remove any dirt which remains with a soft paint brush or a cloth dampened with a mild detergent and water solution. A cotton-tipped applicator is useful for cleaning in narrow spaces or for cleaning ceramic terminal strips and circuit boards.

The high-voltage circuits, particularly parts located in the high-voltage compartment and the area surrounding the post-deflection anode connector, should receive special attention. Excessive dirt in these areas may cause high-voltage arcing and result in improper instrument operation.

### Lubrication

**General.** The reliability of potentiometers, rotary switches and other moving parts can be maintained if they are kept properly lubricated. Use a cleaning-type lubricant (e.g., Tektronix Part No. 006-0218-00) on switch contacts. Lubricate switch detents with a heavier grease (e.g., Tektronix Part No. 006-0219-00). Potentiometers which are not permanently sealed should be lubricated with a lubricant which does not affect electrical characteristics (e.g., Tektronix Part No. 006-0220-00). This lubricant can also be used on shaft bushings. Do not over lubricate. A lubrication kit containing the necessary lubricants and instructions is available from Tektronix, Inc. Order Tektronix Part No. 003-0342-00.

**Fan.** The fan-motor bearings are sealed and do not require lubrication.

### Visual Inspection

The 454A should be inspected occasionally for such defects as broken connections, broken or damaged ceramic strips, improperly seated transistors, damaged circuit boards and heat damaged parts.

The corrective procedures for most visible defects is obvious; however, particular care must be taken if heat-damaged components are found. Overheating usually indicates other trouble in the instrument; therefore, it is important that the cause of overheating be corrected to prevent recurrence of the damage.

### Transistor Checks

Periodic checks of the transistors in the 454A are not recommended. The best check of transistor performance is its actual operation in the instrument. More details on checking transistor operation are given under Troubleshooting.

### Recalibration

To assure accurate measurements, check the calibration of this instrument after each 1000 hours of operation or every six months if used infrequently. In addition, replacement of components may necessitate recalibration of the affected circuits. Complete calibration instructions are given in the Calibration section.

The calibration procedure can also be helpful in localizing certain troubles in the instrument. In some cases, minor troubles may be revealed and/or corrected by recalibration.

## TROUBLESHOOTING

### Introduction

The following information is provided to facilitate troubleshooting of the 454A. Information contained in other sections of this manual should be used along with the following information to aid in locating the defective component. An understanding of the circuit operation is very helpful in locating troubles. See the Circuit Description section for complete information.

### Troubleshooting Aids

**Diagrams.** Circuit diagrams are given on foldout pages in Section 8. The component number and electrical value of each component in this instrument are shown on the

diagrams. Each main circuit is assigned a series of component numbers. Table 4-1 lists the main circuits in the 454A and the series of component numbers assigned to each. Important voltages and waveforms are also shown on the diagrams. The portions of the circuit mounted on circuit boards are enclosed with a blue line.

TABLE 4-1  
Component Numbers

Component Numbers on Diagrams	Diagram Number	Circuit
1 - 99	1	Channel 1 Vertical Preamp
100 - 199	2	Channel 2 Vertical Preamp
200 - 299	3	Vertical Switching
300 - 499	4	Vertical Output Amplifier
500 - 599	5	Trigger Preamp
600 - 699	6	A Trigger Generator
700 - 799	7	A Sweep Generator
800 - 899	8	B Trigger Generator
900 - 999	9	B Sweep Generator
1000 - 1099	11	Horizontal Amplifier
1100 - 1199	13	Power Supply
1200 - 1269	14	Power Distribution
1270 - 1299	15	Calibrator
1300 - 1399	16	Z Axis Amplifier
1400 - 1499	17	CRT Circuit

**Switch Wafer Identification.** Switch wafers shown on the diagrams are coded to indicate the position of the wafer in the complete switch assembly. The numbered portion of the code refers to the wafer number counting from the front, or mounting end of the switch, toward the rear. The letters F and R indicate whether the front or rear of the wafer performs the particular switching function. For example, a wafer designated 2R indicates that the rear of the second wafer (from the front) is used for this particular switching function.

**Circuit Boards.** Figs. 8-1 through 8-16 show the circuit boards used in the 454A. Fig. 4-4 shows the location of each board within the instrument. Each electrical component on the boards is identified by its circuit number. The circuit boards are also outlined on the diagrams with a blue line. These pictures, used along with the diagrams, aid in locating the components mounted on the circuit boards.

**Wiring Color-Code.** All insulated wires and cables used in the 454A are color-coded to facilitate circuit tracing. Table 4-2 gives the wiring color code used in this instrument.

TABLE 4-2  
Wiring Color Code

Supply or Function	Background Color	Stripe <sup>1</sup>
-12 volt	Violet	Black
+12 volt	Red	Black
+75 volt	Red	Brown
+150 volt	Red	Orange
Chassis Ground	Black <sup>2</sup>	
Safety Ground	Green	Yellow
AC (internal)	Gray <sup>2</sup>	Footnote 3
Bulb Filaments	Brown	Footnote 3

<sup>1</sup> If more than one stripe appears on a lead, extra stripes are for lead identification only (for circuit tracing).

<sup>2</sup> See WARNING note concerning power-cord color code.

<sup>3</sup> All stripes for lead identification only (for circuit tracing).

**WARNING**

*This color code applies to leads within the 454A only. Color code of the AC power cord is:*

<i>Black</i>	<i>Line</i>
<i>White</i>	<i>Neutral</i>
<i>Green</i>	<i>Safety earth (ground)</i>

**Resistor Color Code.** In addition to the brown composition resistors, some metal-film resistors (identifiable by their gray body color) and some wire-wound resistors (usually light blue or gray-green) are used in the 454A. The resistance values of wire-wound resistors are printed on the body of the component. The resistance values of composition resistors and metal-film resistors are color-coded on the components with EIA color-code (some metal-film resistors may have the value printed on the body). The color-code is read starting with the stripe nearest the end of the resistor. Composition resistors have four stripes which consist of two significant figures, a multiplier and a tolerance value (see Fig. 4-1). Metal-film resistors have five stripes consisting of three significant figures, a multiplier and a tolerance value.

**Capacitor Marking.** The capacitance values of common disc capacitors and small electrolytics are marked in microfarads on the side of the component body. The white ceramic capacitors used in the 454A are color coded in picofarads using a modified EIA code (see Fig. 4-1).

**Diode Color Code.** The cathode end of each glass encased diode is indicated by a stripe, a series of stripes or a dot. For most silicon or germanium diodes with a series of

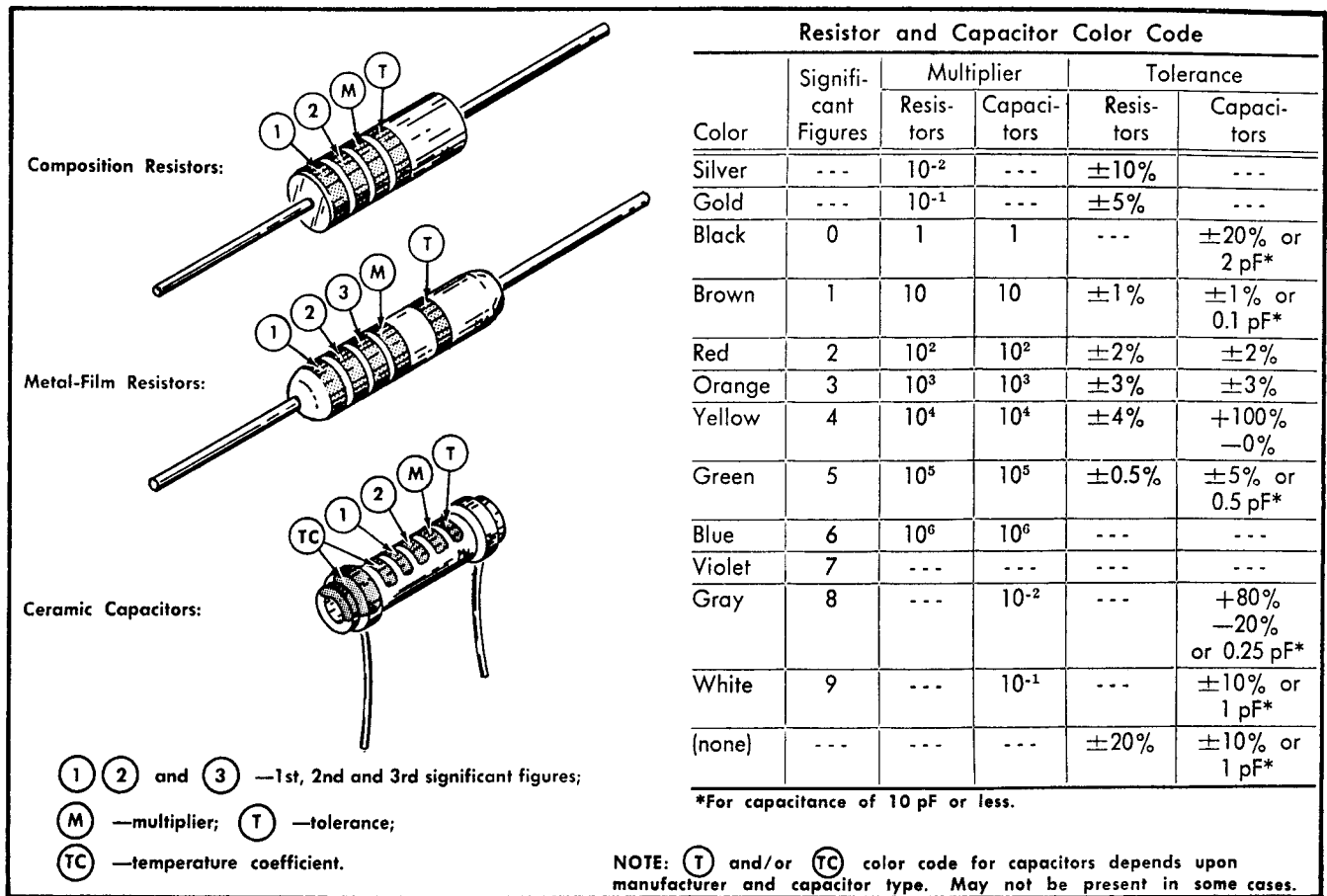

Fig. 4-1. Color-code for resistors and ceramic capacitors.

stripes, the color code also indicates the type of diode and identifies the Tektronix Part Number using the resistor color-code system (e.g., a diode color-coded blue-brown-gray-green indicates a diode with Tektronix Part Number 152-0185-00). The cathode and anode end of metal-encased diodes can be identified by the diode symbol marked on the body.

**Semiconductor Lead Configuration.** Fig. 4-2 shows the lead configurations of the semiconductors used in this instrument. This view is as seen from the bottom of the device.

**Troubleshooting Equipment**

The following equipment is useful for troubleshooting the 454A.

**1. Transistor Tester**

Description: Tektronix Type 576 Transistor-Curve Tracer or equivalent.

Purpose: To test the semiconductors used in this instrument.

**2. Multimeter**

Description: VTVM 10 megohm input impedance and 0 to 500 volts range: ohmmeter, 0 to 20 megohms. Accuracy, within 3%. Test prods must be well insulated to prevent accidental shorting.

Purpose: To check voltages and for general troubleshooting in this instrument.

**NOTE**

A 20,000 ohms/volt VOM can be used to check the voltages in this instrument if allowances are made for the circuit loading of the VOM at high-impedance points.

**3. Test Oscilloscope**

Description: DC to 50 MHz frequency response, 5 millivolts to 10 volts/division deflection factor. A 10X probe should be used to reduce circuit loading.

Purpose: To check waveforms in this instrument.

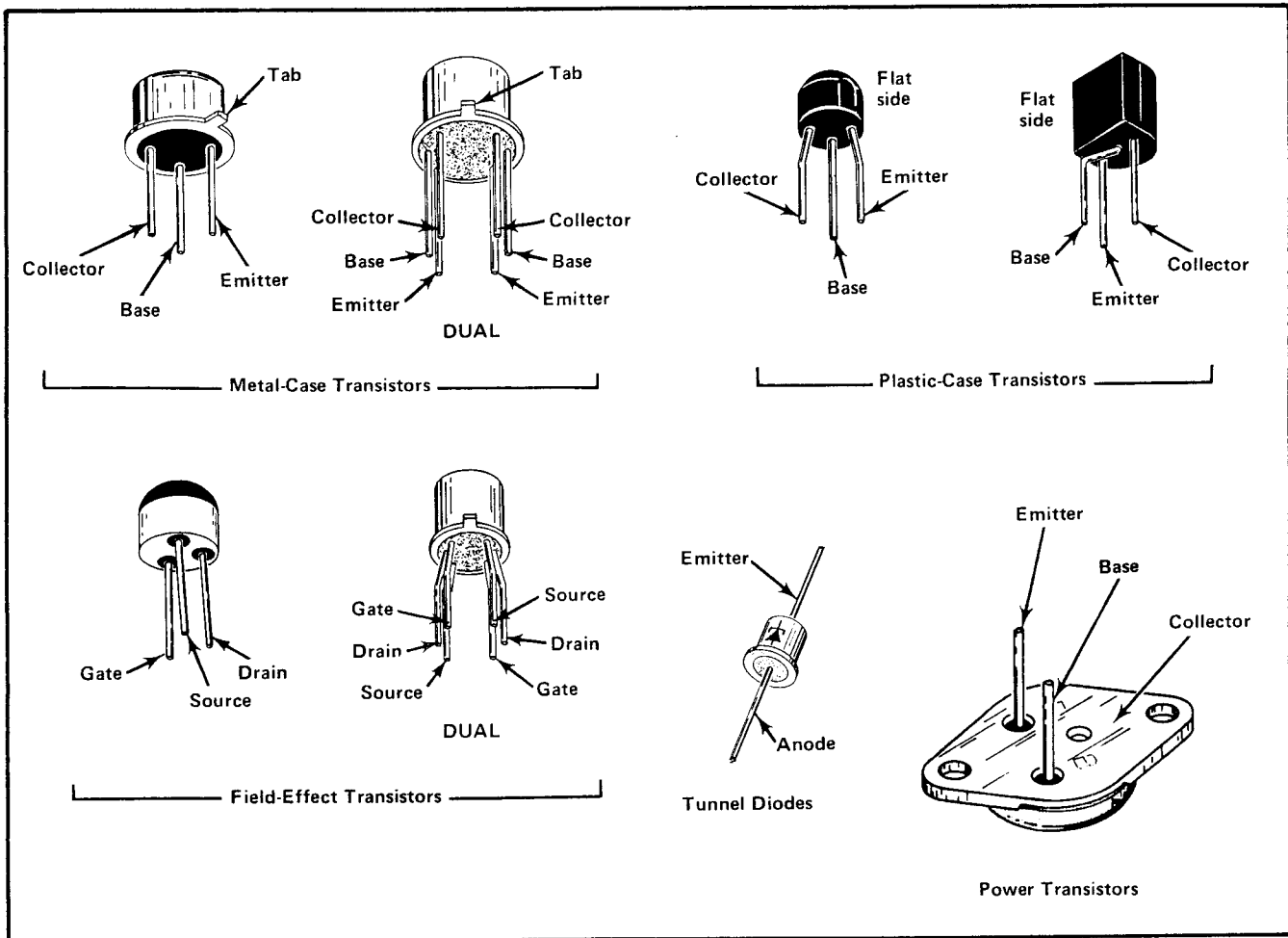

Fig. 4-2. Electrode configuration for semiconductors in this instrument.

## Troubleshooting Techniques

This troubleshooting procedure is arranged in an order which checks the simple trouble possibilities before proceeding with extensive troubleshooting. The first few checks assure proper connection, operation and calibration. If the trouble is not located by these checks, the remaining steps aid in locating the defective component. When the defective component is located, it should be replaced following the replacement procedure given under Corrective Maintenance.

**1. Check Control Settings.** Incorrect control settings can indicate a trouble that does not exist. If there is any question about the correct function or operation of any control, see the Operating Instructions section of this manual.

**2. Check Associated Equipment.** Before proceeding with troubleshooting of the 454A, check that the equipment used with this instrument is operating correctly. Check that the signal is properly connected and that the interconnecting cables are not defective. Also, check the power source.

**3. Check Instrument Calibration.** Check the calibration of this instrument, or the affected circuit if the trouble exists in one circuit. The apparent trouble may only be a result of misadjustment or may be corrected by calibration. Complete calibration instructions are given in the Calibration section of this manual.

**4. Visual Check.** Visually check the portion of the instrument in which the trouble is located. Many troubles can be located by visual indications such as unsoldered connections, broken wires, damaged circuit boards, damaged components, etc.

**5. Isolate Trouble to a Circuit.** To isolate a trouble to a circuit, note the trouble symptom. The symptom often identifies the circuit in which the trouble is located. For example, poor focus indicates that the CRT circuit (includes high voltage) is probably at fault. When trouble symptoms appear in more than one circuit, check all the affected circuits by taking voltage and waveform readings. Also check for the correct output signals at the output connectors with a test oscilloscope. If the signal is correct,

the circuit is working correctly up to that point. For example, correct sawtooth output at the A SWEEP connector indicates that the A Trigger Generator and A Sweep Generator circuits are operating correctly.

Incorrect operation of all circuits often indicates trouble in the power supply. Check first for correct voltage of the individual supplies. However, a defective component elsewhere in the instrument can appear as a power-supply trouble and may also affect the operation of other circuits. A short circuit in any regulated supply causes the output level of all supplies in this instrument to drop to zero until the short is removed. A short in the +150-volt unregulated supply causes the output of the regulated supplies to drop and also opens the 150 V fuse. If the output level of all the supplies is incorrect, check that the Line Voltage Selector Assembly is set for the correct line voltage and regulating range. Table 4-3 lists the tolerances of the power supplies in this instrument. If a power-supply voltage is within the listed tolerance, the supply can be assumed to be working correctly. If outside the tolerance, the supply may be misadjusted or operating incorrectly. Use the procedure given in the Calibration section to adjust the power supplies.

TABLE 4-3

Power Supply Tolerance

Power Supply	Tolerance	Typical Ripple (maximum)
-1960 volt	±58.5 volts	
-12 volt	±0.12 volt	2 millivolts
+12 volt	12.1 volts, ±0.21 volt <sup>1</sup>	2 millivolts
+75 volt	±0.75 volt	2 millivolt

<sup>1</sup> Adjusted for correct output from the Calibrator circuit; see Calibration Procedure.

Fig. 4-3 provides a guide to aid in locating a defective circuit. This chart may not include checks for all possible defects; use steps 6–8 in such cases. Start from the top of the chart and perform the given checks on the left side of the page until a step is found which does not produce indicated results. Further checks and/or the circuit in which the trouble is probably located are listed to the right of this step.

After the defective circuit has been located, proceed with steps 6 through 8 to locate the defective component(s).

**6. Check Circuit Board Interconnections.** After the trouble has been isolated to a particular circuit, check the pin connectors on the circuit board for correct connection. Figs. 8-1 through 8-16 show the correct connections for each board.

The pin connectors used in this instrument also provide a convenient means of circuit isolation. For example, if the power supply is shorted, the defective circuit can be isolated by disconnecting the pin connectors at the boards until the shorting condition is removed.

**7. Check Voltages and Waveforms.** Often the defective component can be located by checking for the correct voltage or waveform in the circuit. Typical voltages and waveforms are given on the diagrams.

NOTE

*Voltages and waveforms given on the diagrams are not absolute and may vary slightly between instruments. To obtain operation conditions similar to those used to take these readings, see the first diagram page.*

**8. Check Individual Components.** The following procedures describe methods of checking individual components in the 454A. Components which are soldered in place are best checked by disconnecting one end. This isolates the measurement from the effects of surrounding circuitry.

**A. TRANSISTORS.** The best check of transistor operation is actual performance under operating conditions. If a transistor is suspected of being defective, it can best be checked by substituting a new component or one which has been checked previously. However, be sure that circuit conditions are such that a replacement transistor will not also be damaged. If substitute transistors are not available, use a dynamic tester (such as Tektronix Type 576). Static-type testers are not recommended, since they do not check operation under simulated operating conditions.

**CAUTION**

*POWER switch must be turned off before removing or replacing transistors.*

**B. DIODES.** A diode can be checked for an open or shorted condition by measuring the resistance between terminals. With an ohmmeter scale having an internal source of between 800 millivolts and 3 volts, the resistance should be very high in one direction and very low when the leads are reversed.

**CAUTION**

*Do not use an ohmmeter scale that has a high internal current. High currents may damage the diode. Do not measure the tunnel diodes with an ohmmeter; use a dynamic tester (such as a Tektronix Type 576 Transistor-Curve Tracer).*



**C. RESISTORS.** Resistors can be checked with an ohmmeter. Check the Electrical Parts List for the tolerance of the resistors used in this instrument. Resistors normally do not need to be replaced unless the measured value varies widely from the specified value.

**D. INDUCTORS.** Check for open inductors by checking continuity with an ohmmeter. Shorted or partially shorted inductors can usually be found by checking the waveform response when high-frequency signals are passed through the circuit. Partial shorting often reduces high-frequency response (roll-off).

**e. CAPACITORS.** A leaky or shorted capacitor can best be detected by checking resistance with an ohmmeter on the highest scale. Do not exceed the voltage rating of the capacitor. The resistance reading should be high after initial charge of the capacitor. An open capacitor can best be detected with a capacitance meter or by checking if the capacitor passes AC signals.

**F. REED-DRIVE COIL.** The reed-drive coil can be checked for correct operation as follows (the coil has four mounting leads for rigidity; make measurements between the two leads on either end of the coil): 1) Check the DC resistance of the coil with an ohmmeter; typical resistance values are given in the electrical parts list. 2) Check the DC voltage drop across the coil when the actuating level is applied. 3) If both the resistance and voltage are correct, the coil can be assumed to be correct; check the reed relay position and continuity. 4) If the resistance is incorrect (take into account surrounding circuitry), disconnect the coil and check the resistance again. 5) If the voltage across the coil is incorrect but the coil resistance is correct, check the circuit originating the actuating level.

**9. Repair and Readjust the Circuit.** If any defective parts are located, follow the replacement procedures given in this section. Be sure to check the performance of any circuit that has been repaired or that has had any electrical components replaced.

## CORRECTIVE MAINTENANCE

### General

Corrective maintenance consists of component replacement and instrument repair. Special techniques required to replace components in this instrument are given here.

### Obtaining Replacement Parts

**Standard Parts.** All electrical and mechanical part replacements for the 454A can be obtained through your local Tektronix Field Office or representative. However,

many of the standard electronic components can be obtained locally in less time than is required to order them from Tektronix, Inc. Before purchasing or ordering replacement parts, check the parts list for value, tolerance, rating and description.

### NOTE

*When selecting replacement parts, it is important to remember that the physical size and shape of a component may affect its performance in the instrument, particularly at high frequencies. All replacement parts should be direct replacements unless it is known that a different component will not adversely affect instrument performance.*

**Special Parts.** In addition to the standard electronic components, some special parts are used in the 454A. These parts are manufactured or selected by Tektronix, Inc. to meet specific performance requirements, or are manufactured for Tektronix, Inc. in accordance with our specifications. These special parts are indicated in the parts list by an asterisk preceding the part number. Most of the mechanical parts used in this instrument have been manufactured by Tektronix, Inc. Order all special parts directly from your local Tektronix Field Office or representative.

**Ordering Parts.** When ordering replacement parts from Tektronix, Inc., include the following information:

1. Instrument Type.
2. Instrument Serial Number.
3. A description of the part (if electrical, include circuit number).
4. Tektronix Part Number.

### Soldering Techniques

#### WARNING

*Disconnect the instrument from the power source before soldering.*

**Circuit Boards.** Use ordinary 60/40 solder and a 35- to 40-watt pencil type soldering iron on the circuit boards. The tip of the iron should be clean and properly tinned for best heat transfer to the solder joint. A higher wattage soldering iron may separate the wiring from the base material.

CIRCUIT ISOLATION TROUBLESHOOTING CHART

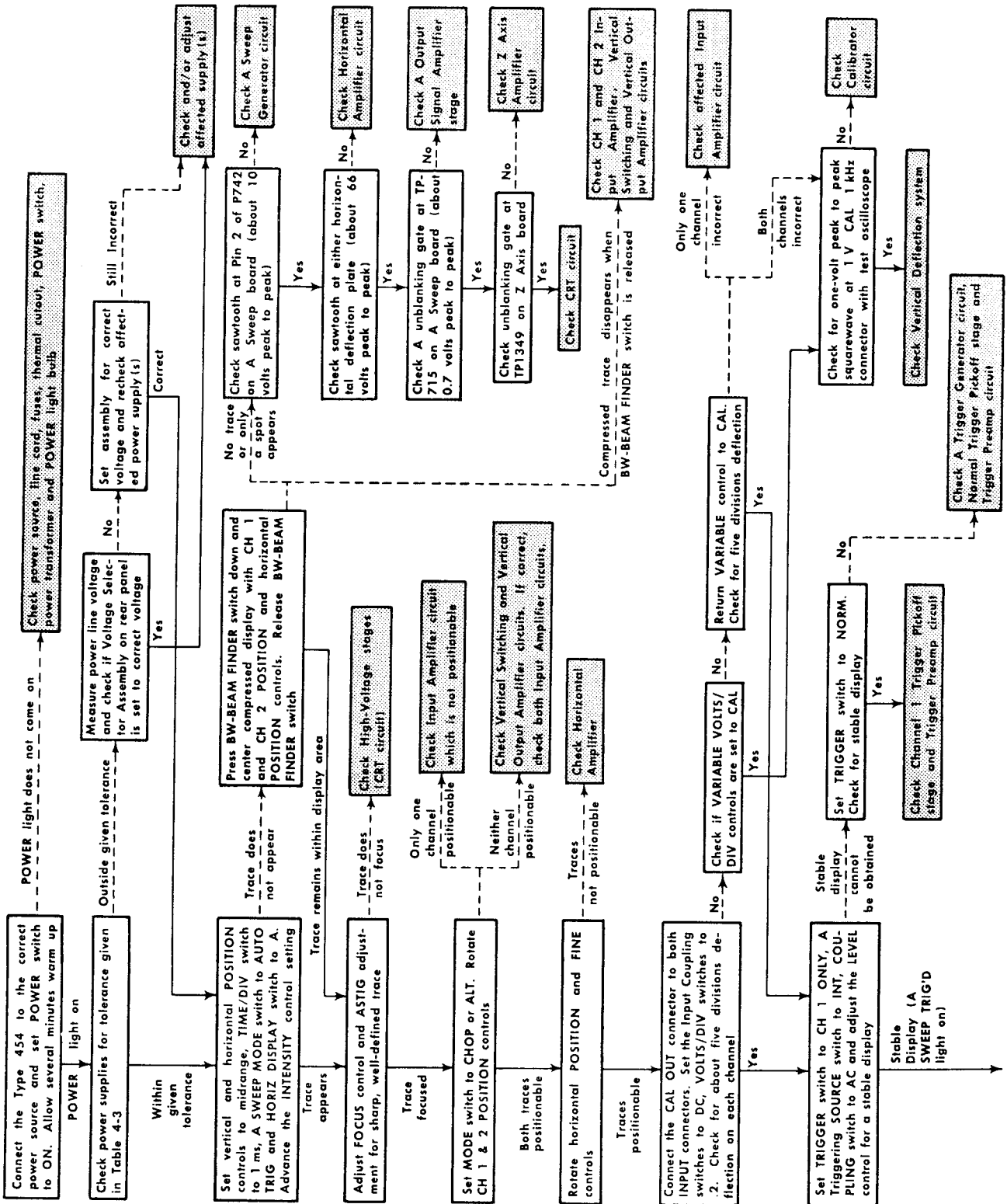

For Service Manuals Contact  
 MAURITRON TECHNICAL SERVICES  
 8 Cherry Tree Rd, Chinnor  
 Oxon OX9 4QY  
 Tel:- 01844-351694 Fax:- 01844-352554  
 Email:- enquiries@mauritron.co.uk

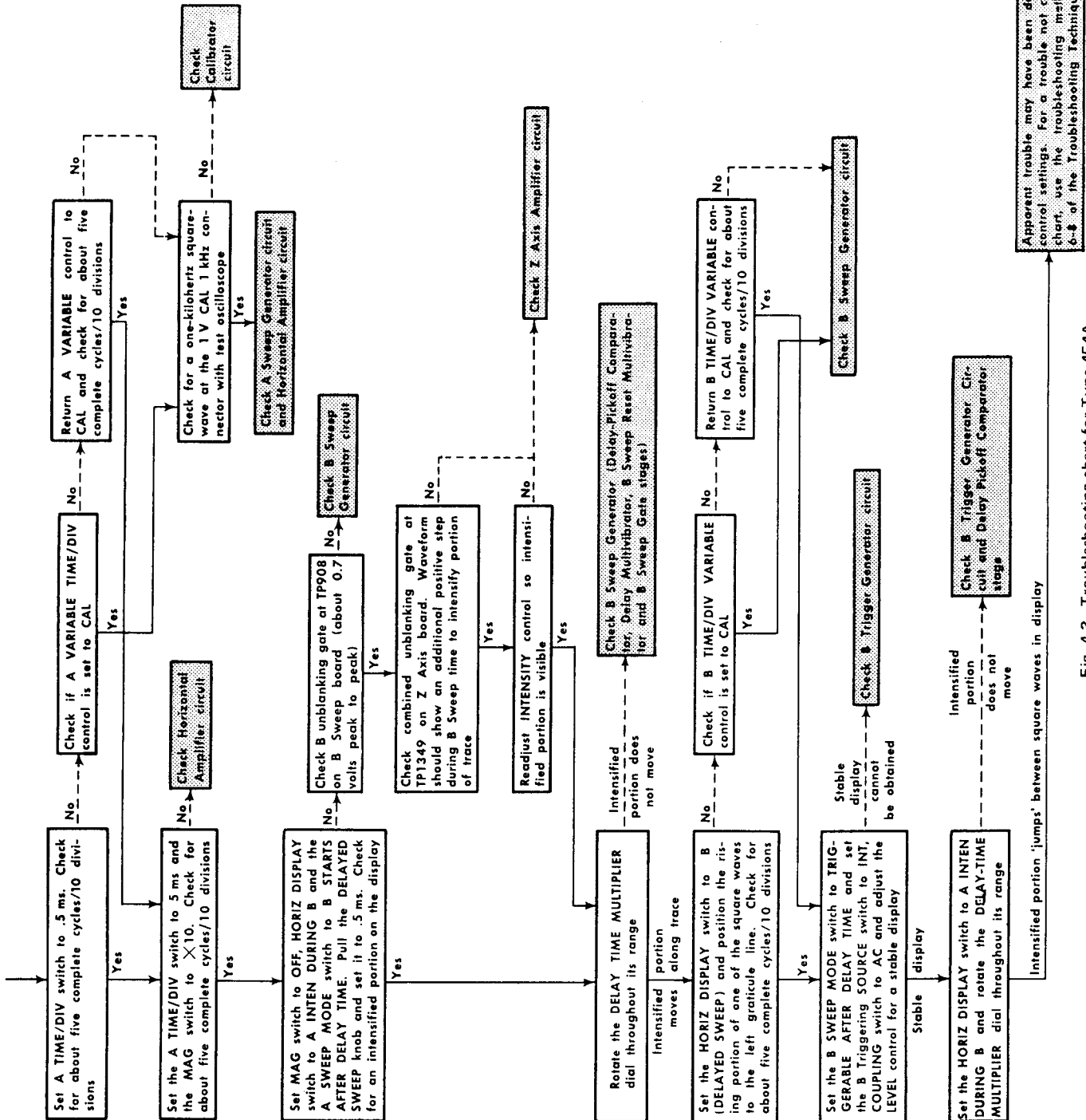

Apparent trouble may have been due to incorrect control settings. For a trouble not covered by this chart, use the troubleshooting methods in steps 6-8 of the Troubleshooting Techniques

Fig. 4-3. Troubleshooting chart for Type 454A.

The following technique should be used to replace a component on a circuit board. Most components can be replaced without removing the boards from the instrument.

1. Grip the component lead with long-nose pliers. Touch the soldering iron to the lead at the solder connection. Do not lay the iron directly on the board, as it may damage the board.

2. When the solder begins to melt, pull the lead out gently. This should leave a clean hole in the board. If not, the hole can be cleaned by reheating the solder and placing a sharp object such as a toothpick into the hole to clean it out. A vacuum-type desoldering tool can also be used for this purpose.

3. Bend the leads of the new component to fit the holes in the board. If the component is replaced while the board is mounted in the instrument, cut the leads so they will just protrude through the board. Insert the leads into the holes in the board so the component is firmly seated against the board (or as positioned originally). If it does not seat properly, heat the solder and gently press the component into place.

4. Touch the iron to the connection and apply a small amount of solder to make a firm solder joint. To protect heat-sensitive components, hold the lead between the component body and the solder joint with a pair of long-nose pliers or other heat sink.

5. Clip the excess lead that protrudes through the board (if not clipped in step 3).

6. Clean the area around the solder connection with a flux-remover solvent. Be careful not to remove information printed on the board.

**Ceramic Terminal Strips.** Solder used on the ceramic terminal strips should contain about 3% silver. Use a 40- to 75-watt soldering iron with a 1/8-inch wide wedge-shaped tip. Ordinary solder can be used occasionally without damage to the ceramic terminal strips. However, if ordinary solder is used repeatedly or if excessive heat is applied, the solder-to-ceramic bond may be broken.

A sample roll of solder containing about 3% silver is mounted on the rear subpanel of this instrument. Additional solder of the same type should be available locally, or it can be purchased from Tektronix, Inc. in one-pound rolls; order by Tektronix Part No. 251-0514-00.

Observe the following precautions when soldering to ceramic terminal strips.

1. Use a hot iron for a short time. Apply only enough heat to make the solder flow freely.

2. Maintain a clean, properly tinned tip.

3. Avoid putting pressure on the ceramic terminal strip.

4. Do not attempt to fill the terminal-strip notch with solder; use only enough solder to cover the wires adequately.

5. Clean the flux from the terminal strip with a flux-remover solvent.

**Metal Terminals.** When soldering metal terminals (e.g., switch terminals, potentiometers, etc.), ordinary 60/40 solder can be used. Use a soldering iron with a 40- to 75-watt rating and a 1/8-inch wide wedge-shaped tip.

Observe the following precautions when soldering metal terminals:

1. Apply only enough heat to make the solder flow freely.

2. Apply only enough solder to form a solid connection. Excess solder may impair the function of the part.

3. If a wire extends beyond the solder joint, clip off the excess.

4. Clean the flux from the solder joint with a flux-remover solvent.

## Component Replacement

**WARNING**

*Disconnect the instrument from the power source before replacing components.*

**Removing the Rear Panel.** The rear panel must be removed for access to the rear subpanel. This panel can be removed by removing the Z Axis ground strap and the screws that secure the instrument feet to the rear casting.

**Removing the Rear Casting.** An alternative method for gaining access to the rear subpanel is to remove the rear casting from the instrument. This is easily accomplished by removing the four flat-head phillips screws that secure the rear casting to the side rails. The rear casting can now be removed by prying it off with a large screwdriver or by

striking the rear casting with a plastic-headed mallet or hammer. Only move the rear casting away from the instrument far enough to unsolder the wire that connects the Z-Axis binding post to the ceramic strip on the rear sub-panel. The rear casting can now be swung away enough to provide free access to the rear subpanel.

**Swing-Out Chassis.** Some of the controls and connectors are mounted on a swing-out chassis on the right side of this instrument. The Calibrator circuit board is also mounted on the rear of this chassis. To reach the rear of this chassis or the components mounted behind it, first remove the top cover from the instrument. Then loosen the captive securing screw so the chassis can swing outward.

**Ceramic Terminal Strip Replacement.** Replacement strips (including studs) and spacers are supplied under separate part numbers. However, the old spacers may be re-used if they are not damaged. The applicable Tektronix Part Numbers for the ceramic strips and spacers used in this instrument are given in the Mechanical Parts List.

To replace a ceramic terminal strip, use the following procedure.

#### REMOVAL:

1. Unsolder all components and connections on the strip. To aid in replacing the strip, it may be advisable to mark each lead or draw a sketch to show location of the components and connections.

2. Pry or pull the damaged strip from the chassis.

3. If the spacers come out with the strip, remove them from the stud pins for use on the new strip (spacers should be replaced if they are damaged).

#### REPLACEMENT:

1. Place the spacers in the chassis holes.

2. Carefully press the studs of the strip into the spacers until they are completely seated. If necessary, use a soft mallet and tap lightly, directly over the stud, to seat the strip completely.

3. If the stud extends through the spacers, cut off the excess.

4. Replace all components and connections. Observe the soldering precautions given under Soldering Techniques in this section.

**Circuit Board Replacement.** If a circuit board is damaged beyond repair, either the entire assembly including all soldered-on components, or the board only, can be replaced. Part numbers are given in the Mechanical Parts List for either the completely wired or the unwired board. Most of the components mounted on the circuit boards can be replaced without removing the boards from the instrument. Observe the soldering precautions given under Soldering Techniques in this section.

#### GENERAL:

Most of the connections to the circuit boards are made with pin connectors. However, several connections are soldered to the Vertical Output Amplifier and Vertical Pre-amp boards. See the special removal instructions to remove these boards.

Use the following procedure to remove a circuit board.

1. Remove all screws holding the board to the chassis.

2. The board may now be lifted for maintenance or access to areas beneath the board.

3. To completely remove the board, disconnect the pin connectors.

4. Remove the cable clamps (if any) holding the cable to the board.

5. Lift the circuit board out of the instrument. Do not force or bend the board.

6. To replace the board, reverse the order of removal. Correct location of the pin connectors is shown in Figs. 8-1 through 8-16. Replace the pin connectors carefully so they mate correctly with the pins. If forced into place incorrectly positioned, the pin connectors may be damaged.

#### VERTICAL PREAMP UNIT REMOVAL:

Use the following procedure to remove the Vertical Pre-amp board and attenuators as a unit.

1. Remove all of the knobs from Input Coupling switches, the VOLTS/DIV switches, the POSITION controls and the Vertical MODE/TRIGGER switch.

2. Remove the extension rod from the CH 2 INVERT switch.

3. Remove the shield from the cast attenuator housing.
4. Remove the two 6-32 keps nuts that retain the cast attenuator housing to the instrument front casting.
5. Unplug the delay line connections from the Vertical Pramp circuit board. Note the order of removal for reconnection.
6. Remove the two screws at the rear of the circuit board.
7. Remove the two 4-40 hex nuts and their flat washers (adjacent to the Vertical MODE/TRIGGER switch shaft) that secure the Vertical Preamp circuit board to the instrument chassis.
8. Lift up on the rear of the assembly and slide it out of the instrument. The top side of the board and the attenuators can now be reached for troubleshooting or parts replacement.
9. The board can now be removed from the Vertical Preamp unit as follows:
  - a. Disconnect all pin connectors.
  - b. Unsolder all connections between the circuit board and the attenuators and between the circuit board and the Vertical MODE/TRIGGER switch.
  - c. Remove the remaining screw that holds the Vertical MODE/TRIGGER switch to the circuit board.
  - d. Remove the four screws that hold the board to the attenuators.
10. To replace the unit, reverse the order of removal. Correct location of the pin connectors is shown in Figs. 8-1 through 8-16.

**Cathode-Ray Tube Replacement.** Use care when handling a CRT. Protective clothing and safety glasses should be worn. Avoid striking it on any object which might cause it to crack or implode. When storing a CRT, place it face down on a smooth surface with a protective cover or soft mat under the faceplate to protect it from scratches. Do not bend the deflection-plate pins. If the pins are bent, the glass seal around the pins may be cracked, allowing the CRT to lose its vacuum.

The CRT shield should also be handled carefully. This shield protects the CRT display from distortion due to magnetic interference. If the shield is dropped or struck sharply, it may lose its shielding ability.

The following procedure outlines the removal and replacement of the cathode-ray tube:

1. Remove the top and bottom covers and rear panel (or rear casting) as described previously.
2. Remove the light filter from the front of the CRT.
3. Disconnect the CRT anode connector. Ground this lead and the anode connection to discharge any stored charge.
4. Disconnect the two ground braids from between the CRT shield and the Vertical Amplifier chassis. Either unsolder the braid or remove the securing nuts from the solder lugs.
5. Remove the two nuts (by the graticule lights) which hold the front of the CRT shield to the front casting.
6. Remove the graticule lights from the studs and position them away from the shield.
7. Remove all deflection leads from the neck of the CRT. Be careful not to bend the pin connectors. Removal of the Vertical deflection leads can be facilitated by removing the two securing screws and lowering the Vertical Amplifier chassis.
8. Remove the CRT socket.
9. Unsolder the y-axis rotation leads at the Y Axis Align control (on the rear subpanel) and the trace rotation leads where they connect to the trace rotation coil in the CRT shield.
10. Remove the small block of foam located between the CRT shield and the DELAY-TIME MULTIPLIER potentiometer.
11. Loosen the two hex-head screws inside the rear of the CRT shield. Remove the shield angle clamps and mounting screws.

12. Slide the CRT assembly to the rear of the instrument until the faceplate clears the mounting studs. Then lift the front of the CRT assembly up and slide the entire assembly out of the instrument.

13. Remove the clear plastic implosion shield and the light pipe assembly from the front of the CRT.

14. On the CRT clamp, loosen the screw that controls how tightly the clamp secures the CRT.

15. Hold the left hand on the CRT faceplate and push forward on the CRT base with the right hand. As the CRT starts out of the shield, grasp it firmly with the left hand. When the CRT is free of the clamp, slide the shield completely off the CRT. Be careful that the neck pins do not catch on the trace rotation coil or other obstructions and bend.

To replace the CRT reverse the above procedure. Use the light pipe lenses as a guide to measure how far the CRT faceplate should extend out of the CRT shield. Do not overtighten the CRT clamp screw. Recommended tightening torque is 4 to 7 inch-lbs. After the CRT is completely re-installed, check the calibration of the High Voltage, TRACE ROTATION, ASTIG, Y-Axis Align and Geometry adjustments. The Vertical and Horizontal circuits should be checked for correct calibration also. Refer to the Performance Check/Calibration section for the correct procedures.

**Transistor Replacement.** Transistors should not be replaced unless they are actually defective. If removed from their sockets during routine maintenance, return them to their original sockets. Unnecessary replacement of transistors may affect the calibration of this instrument. When transistors are replaced, check the operation of that part of the instrument which may be affected.

**CAUTION**

*POWER switch must be turned off before removing or replacing transistors.*

Replacement transistors should be of the original type or a direct replacement. Fig. 4-2 shows the lead configuration of the semiconductors used in this instrument. Some plastic case transistors have lead configurations which do not agree with those shown here. If a transistor is replaced by a transistor made by a different manufacturer than the original, check the manufacturer's basing diagram for correct basing. All transistor sockets in this instrument are wired for the basing used for metal-case transistors. The transistor sockets

on the Vertical Output Amplifier circuit board and the thick film hybrid circuit have individual sockets for each lead. These sockets are placed in the standard lead configuration. Transistors which are mounted on the chassis use silicone grease to increase heat transfer. Replace the silicone grease when replacing these transistors.

**WARNING**

*Handle silicone grease with care. Avoid getting silicone grease in the eyes. Wash hands thoroughly after use.*

**Fuse Replacement.** The power-line fuses are located on the rear panel in the Voltage Selector Assembly. Power-supply fuses are located beside the power transformer. Table 4-4 gives the value and locations of the fuses used in this instrument.

TABLE 4-4  
Fuse Ratings

Circuit Number	Rating	Location	Function
F1101	2A Fast	Voltage Selector Assembly	115-volt line
F1102	1A Fast	Voltage Selector Assembly	230-volt line
F1204	0.25A Fast	By power transformer	+150 volts
F1437	2A Fast	By power transformer	High voltage

**Glass Reed-Relays Replacement.** The glass reed-relays used in this instrument are pressurized. Therefore, safety glasses should be worn to protect the eyes when replacing these relays. To avoid damage to the reed-relays, do not apply stress to the metal-glass bond. When it is necessary to bend a lead, use two pairs of long-nose pliers. Before replacing a reed-relay, be sure the actuating circuitry is not at fault. See the Troubleshooting procedure for methods of checking the circuit. It is important that the replacement reed-relay be correctly positioned within the drive-coil assembly with the same lead length as the original to provide similar magnetic characteristics.

**REMOVAL:**

1. Observe the physical position of the leads and glass bulb of the old reed-relay.

2. Unsolder the leads of the old reed-relay from the solder posts.

3. Pull the old reed-relay out of the drive-coil.

#### REPLACEMENT:

1. Slip the new reed-relay into the drive-coil.
2. Position the new reed-relay in exactly the same physical position as the old one.
3. Position the leads correctly and solder the new reed-relay to the solder posts. Avoid excessive heat on the reed-relay; use a heat sink on the leads if soldering close to the glass body.
4. Clip off the excess lead length beyond the solder posts. Do not clip the lead closer than 1/4 inch from the glass body.

**Rotary Switches.** Individual wafers or mechanical parts of rotary switches are normally not replaceable. If a switch is defective, replace the entire assembly. Replacement switches can be ordered either wired or unwired; refer to the Electrical Parts List for the applicable part numbers.

When replacing a switch, tag the leads and switch terminals with corresponding identification tags as the leads are disconnected. Then, use the old switch as a guide for installing the new one. An alternate method is to draw a sketch of the switch layout and record the wire color at each terminal. When soldering to the new switch, be careful that the solder does not flow beyond the rivets of the switch terminals. Spring tension of the switch contact can be destroyed by excessive solder.

The swing-out chassis on the right side of the instrument provides access to the side of the TIME/DIV and HORIZ DISPLAY switches. The top and bottom of these switches can be reached for easier repair or removal by removing the B Sweep board (top) or the A Sweep board (bottom).

**Power Transformer Replacement.** If the power transformer becomes defective, contact your local Tektronix Field Office or representative for a replacement (see the Warranty note in the front of this manual). Be sure to replace only with a direct replacement Tektronix transformer.

When removing the transformer, tag the leads with the corresponding terminal numbers to aid in connecting the new transformer. After the transformer is replaced, check the performance of the complete instrument using the Performance Check Procedure.

**High Voltage Compartment.** The components located in the high-voltage compartment can be reached for maintenance or replacement by using the following procedure.

1. Remove the bottom cover of the instrument as described in this section.
2. Remove the high-voltage shield by loosening the three screws securing it.
3. Remove the two screws which hold the plastic cover on the high-voltage compartment and remove the cover.
4. To remove the complete wiring assembly from the high-voltage compartment, remove the two screws which go through the transformer. Be careful not to lose the heat-sink block beneath the high-voltage transformer. Also remove the plastic screw on the other end of the high-voltage compartment. Now, unsolder the post-deflection anode lead (heavily insulated lead at the side of the compartment). The other leads are long enough to allow the assembly to be lifted out of the compartment to reach the parts on the under side.
5. To replace the high-voltage compartment, reverse the order of removal.

#### NOTE

*All solder joints in the high-voltage compartment should have smooth surfaces. Any protrusions may cause high-voltage arcing at high altitudes.*

**Power Chassis.** The power transistors and other heat dissipating power-supply components are mounted below the Low-Voltage Regulator board. Remove the Low-Voltage Regulator board to reach these components. To reach the underside of the chassis, remove the fan through the rear subpanel.

#### Recalibration After Repair

After any electrical component has been replaced, the calibration of that particular circuit should be checked, as well as the calibration of other closely related circuits. Since the low-voltage supply affects all circuits, calibration of the entire instrument should be checked if work has been done in the low-voltage supply or if the power transformer has been replaced. The Performance Check Procedure in Section 5 provides a quick and convenient means of checking instrument operation.



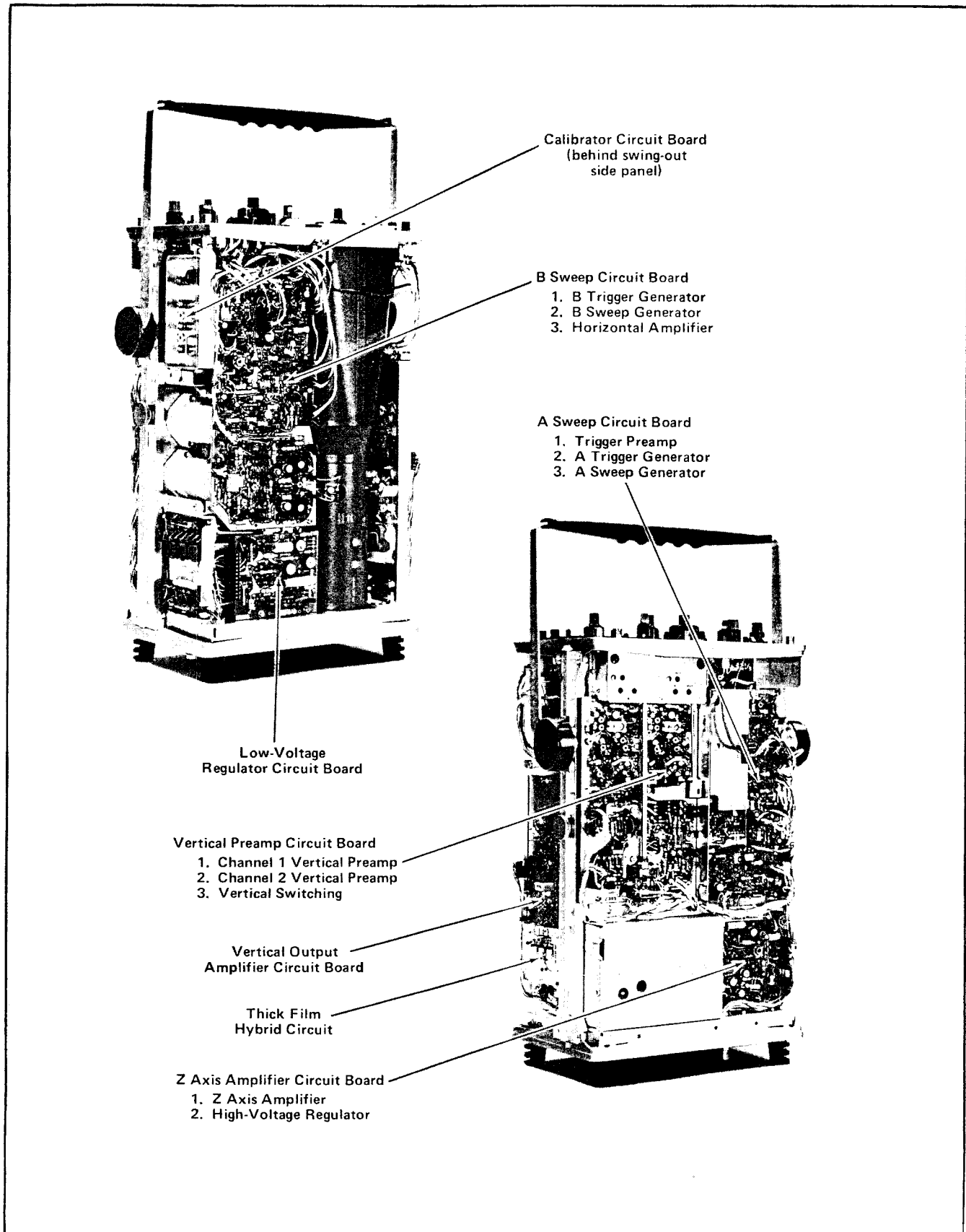

Fig. 4-4. Location of circuit boards in the 454A.

## NOTES

For Service Manuals Contact  
TECHNICAL SERVICES  
11, Chinnor  
9 40Y  
Tel: 01895 55554  
Email: [technical@monit.co.uk](mailto:technical@monit.co.uk)

# SECTION 5

## CALIBRATION

*Change information, if any, affecting this section will be found at the rear of this manual.*

### Introduction

To assure instrument accuracy, check the calibration of the 454A every 1000 hours of operation, or every six months if used infrequently. Before complete calibration, thoroughly clean and inspect this instrument as outlined in the Maintenance section.

### Tektronix Field Service

Tektronix, Inc. provides complete instrument repair and recalibration at local Field Service Centers and the Factory Service Center. Contact your local Tektronix Field Office or representative for further information.

### Using This Procedure

**General.** This section provides several features to facilitate checking or adjusting the 454A. These are:

**Index.** To aid in locating a step in the Performance Check or Adjustment procedure, an index is given preceding Part I — Performance Check and Part II — Adjustment procedure.

**Performance Check.** The performance of this instrument can be checked without removing the covers or making internal adjustments by performing only Part I — Performance Check. This procedure checks the instrument against tolerances listed in the Performance Requirement column of Section 1. Screwdriver adjustments which are accessible from the exterior of the instrument are adjusted as part of the Performance Check procedure. In addition, a cross-reference is provided to the step in Part II — Adjustment which will return the instrument to correct calibration. In most cases, the adjustment step can be performed without changing control settings or equipment connections.

**Adjustment Procedure.** To return this instrument to correct calibration with the minimum number of steps, perform only Part II — Adjustment. The adjustment procedure gives the recommended calibration procedure for all circuits in this instrument. It also includes check procedures for those functions which cannot be checked without removing the covers (e.g., power-supply ripple). Procedures are not given for checks which can be made without removing the covers: see Part I — Performance Check for the correct procedure for making these checks.

**Partial Procedure.** A partial check or adjustment is often desirable after replacing components or to touch up the adjustment of a portion of the instrument between major recalibrations. To check or adjust only part of the instrument, set the controls as given under Preliminary Control Settings and start with the nearest Equipment Required list preceding the desired portion. To prevent unnecessary recalibration of other parts of the instrument, readjust only if the tolerance given in the CHECK— part of the step is not met. If readjustment is necessary, also check the calibration of any steps listed in the INTERACTION— part of the step.

**Complete Performance Check/Adjustment.** To completely check and adjust all parts of this instrument, perform both Parts I and II. Start the complete procedure by adjusting the power supply as given in the Adjustment procedure. Then perform the Adjustment procedure for a portion of the instrument (e.g., Vertical System Adjustment) and follow this with the Performance Check for the same portion (e.g., Vertical System Check). This method will assure that the instrument is correctly adjusted and performing within all given specifications.

### IMPORTANT NOTE

*All waveforms shown in this section were taken with a Tektronix Oscilloscope Camera System, unless noted otherwise.*

### TEST EQUIPMENT REQUIRED

#### General

The following test equipment and accessories, or its equivalent, is required for complete calibration of the 454A. Specifications given for the test equipment are the minimum necessary for accurate calibration. Therefore, some of the specifications listed here may differ from the actual performance capabilities of the test equipment. All test equipment is assumed to be correctly calibrated and operating within the listed specifications.

If only a Performance Check procedure or an Adjustment procedure is performed, not all of the listed test equipment will be required. Items used only for the Performance Check procedure are indicated by footnote 1 while items required only for an Adjustment procedure are indi-

## Calibration—454A/R454A

cated by footnote 2. The remaining items are pieces of equipment common to both a Performance Check procedure and an Adjustment procedure.

The Performance Check and Adjustment procedures are based on this recommended equipment. If other equipment is substituted, control settings or calibration setup may need to be altered to meet the requirements of the equipment used. Detailed operating instructions for the test equipment are not given in this procedure. Refer to the instruction manual for the test equipment if more information is needed.

### Special Calibration Fixtures

Special Tektronix calibration fixtures are used in this procedure only where they facilitate instrument calibration. These special calibration fixtures are available from Tektronix, Inc. Order by part number through your local Tektronix Field Office or representative.

### Calibration Equipment Alternatives

All of the listed test equipment is required to completely check and adjust this instrument. However, complete checking or adjustment may not always be necessary or desirable. The user may be satisfied with checking only selected characteristics, thereby reducing the amount of test equipment actually required. For example, the basic measurement capabilities of this instrument can be verified by checking vertical deflection accuracy using a Standard Amplitude Calibrator, vertical step response using a Type 109/Type 113 combination, and horizontal timing accuracy using a Time-Mark Generator.

1. Variable autotransformer.<sup>2</sup> Must be capable of supplying 200 volt-amperes over a range of 90 to 136 volts (180 to 272 volts for 230-volt nominal line). (If autotransformer does not have an AC voltmeter to indicate output voltage, monitor the output with an AC voltmeter with range of at least 136 or 272 volts, RMS.) For example, General Radio W10MT3W Metered Variac Autotransformer (note that the full current capabilities of this unit are not required).

2. Precision DC voltmeter.<sup>2</sup> Accuracy, within  $\pm 0.05\%$ ; meter resolution, 50 microvolts; range, zero to two kilovolts. For example, Fluke Model 825A Differential DC Voltmeter (use Fluke Model 80E-2 Voltage Divider to measure voltages above 500 volts).

<sup>1</sup> Used only for Performance Check procedure.

<sup>2</sup> Used only for Adjustment procedure.

3. Test Oscilloscope. Bandwidth, DC to 50 MHz; minimum deflection factor, five millivolts/division; accuracy, within 3%. Tektronix 453A or 454A Oscilloscope recommended.

4. 1X probe with BNC connector.<sup>2</sup> Tektronix P6011 Probe recommended.

5. 10X probe with BNC connector. Tektronix P6010 or P6047 recommended.

6. Time-mark generator. Marker outputs, five seconds to five nanoseconds; marker accuracy, within 0.1%. Tektronix Type 2901 Time-Mark Generator recommended.

7. Standard amplitude calibrator. Amplitude accuracy, within 0.25%; signal amplitude, five millivolts to 50 volts; output signal, one-kilohertz square-wave and positive DC voltage. Tektronix calibration fixture 067-0502-01 recommended.

8. Square-wave generator.<sup>2</sup> Frequency, one kilohertz and one megahertz; risetime, one nanosecond or less from fast-rise output; output amplitude, about 120 volts unterminated or 12 volts into 50 ohms. Tektronix Type 106 Square-Wave Generator recommended.

9. Fast-rise, high-amplitude pulse generator.<sup>2</sup> Risetime, 0.25 nanosecond or less; repetition rate, 550 to 720 pulses/second; amplitude, variable from 20 millivolts to ten volts. Tektronix Type 109 Pulse Generator recommended.

10. Charge line.<sup>2</sup> Impedance, 50 ohms, electrical length, 60 nanoseconds; connectors, GR874. Tektronix Type 113 Delay Cable recommended.

11. Signal insertion unit.<sup>2</sup> Input connector, GR874 (Tektronix P6040 probe); output connectors, fits delay-line input jacks of 454A; purpose, to adjust compensation of Vertical Output Amplifier. Tektronix Calibration Fixture 067-0553-01 and P6040 probe, Tektronix Part No. 010-0133-00 recommended.

12. Signal pickoff. Connectors, GR874 thru-signal connectors and BNC signal-pickoff connector. Tektronix Type CT-3 50  $\Omega$  Signal Pickoff recommended (Tektronix Part No. 017-0061-00).

13. High-frequency constant-amplitude sine-wave generator.<sup>1</sup> Frequency, 65 megahertz to above 150 megahertz;

reference frequency, three megahertz; output amplitude, variable from 0.5 volt to four volts; amplitude accuracy, within 1% at three megahertz and from 65 megahertz to 150 megahertz. Tektronix calibration fixture 067-0532-01 recommended.

14. Medium-frequency constant-amplitude sine-wave generator. Frequency, 350 kilohertz to 100 megahertz; reference frequency, 50 kilohertz; output amplitude, variable from five millivolts to five volts into 50 ohms or 10 volts unterminated; amplitude accuracy, within 3% at 50 kilohertz and from 350 kilohertz to 100 megahertz. Tektronix Type 191 Constant Amplitude Signal Generator recommended.

15. Low-frequency sine-wave generator.<sup>1</sup> Frequency, 10 hertz to 100 kilohertz; output amplitude, variable from 0.5 volts to 40 volts peak to peak; amplitude accuracy, within 3% from 10 hertz to 100 kilohertz. For example, General Radio 1310-A Oscillator (use a General Radio Type 274QBJ Adaptor to provide BNC output).

16. Current-measuring probe with passive termination.<sup>1</sup> Sensitivity, two milliamperes/millivolt; accuracy, within 3%. Tektronix P6021 Current Probe with 011-0105-00 passive termination recommended.

17. Cable (two). Impedance, 50 ohms; type RG-58/U; length, 42 inches; connectors, BNC. Tektronix Part No. 012-0057-00.

18. BNC T connector.<sup>1</sup> Tektronix Part No. 103-0030-00.

19. Cable. Impedance, 50 ohms; type RG-58/U; length, 18 inches; connectors, BNC. Tektronix Part No. 012-0076-00.

20. Cable (two). Impedance, 50 ohms; type RG-213/U; electrical length, five nanoseconds; connectors, GR874. Tektronix Part No. 017-0502-00.

21. In-line termination. Impedance, 50 ohms; wattage rating, two watts; accuracy,  $\pm 3\%$ ; connectors, GR874 input with BNC male output. Tektronix Part No. 017-0083-00.

22. Input RC normalizer.<sup>2</sup> Time constant, 1 megohm X 15 pF; attenuation, 2X; connectors, BNC. Tektronix calibration fixture 067-0537-00.

23. 10X attenuator (two).<sup>1</sup> Impedance, 50 ohms; accuracy,  $\pm 3\%$ ; connectors, GR874. Tektronix Part No. 017-0078-00.

24. Dual-input coupler. Matched signal transfer to each input, Tektronix calibration fixture 067-0525-00.

25. Adapter.<sup>2</sup> Adapts GR874 connector to BNC female connector. Tektronix Part No. 017-0064-00.

26. Termination. Impedance, 50 ohms; accuracy,  $\pm 3\%$ ; connectors, BNC. Tektronix Part No. 011-0049-01.

27. Adapter.<sup>1</sup> Connectors, BNC female and two alligator clips. Tektronix Part No. 013-0076-00.

28. Screwdriver. Three-inch shaft. Tektronix Part No. 003-0192-00.

29. Low-capacitance screwdriver.<sup>2</sup> 1 1/2-inch shaft. Tektronix Part No. 003-0000-00.

30. Tuning tool.<sup>2</sup> Handle and insert for 5/64-inch (ID) hex cores. Tektronix Part Nos. 003-0307-00 and 003-0310-00.

31. Elbow.<sup>2</sup> Impedance, 50 ohms; connectors, GR874. Tektronix Part No. 017-0070-00.

32. Short-circuit termination.<sup>2</sup> Connector, GR874. Tektronix Part No. 017-0087-00.

33. Two-nanosecond risetime low-pass filter. Connector, GR874. Tektronix Part No. 067-0635-00.

34. Adapter.<sup>2</sup> Connectors, GR874 and BNC female. Tektronix Part No. 103-0045-00.

35. Adapter.<sup>2</sup> Connectors, BNC male. Tektronix Part No. 103-1029-00.

**Preliminary Control Settings**

Preset the instrument controls to the settings given below when starting a Performance Check or an Adjustment procedure.

**CRT Controls**

INTENSITY	Midrange
FOCUS	Midrange
SCALE ILLUM	As desired
BANDWIDTH- BEAM FINDER	FULL

**Vertical Controls (both channels if applicable)**

VOLTS/DIV	10 mV
VAR	Calibrated detent
POSITION	Midrange
Input Coupling	DC
MODE	CH 1
INT TRIGGER	NORM
INVERT	Pushed in

**Triggering Controls (both A and B if applicable)**

LEVEL	0
SLOPE	+
COUPLING	AC
SOURCE	INT

**Sweep Controls**

DELAY-TIME	
MULTIPLIER	0.10
A TIME/DIV	1 ms
B TIME/DIV	1 ms
A VAR	CAL
B TIME/DIV VAR	CAL
A SWEEP MODE	AUTO TRIG
B SWEEP MODE	TRIGGERABLE AFTER DELAY TIME
HORIZ DISPLAY	A
MAG	OFF
A SWEEP LENGTH	FULL
POSITION	Midrange
POWER	ON

**NOTES**

---

---

---

---

---

---

---

---

---

---

---

---

---

---

---

---

---

---

---

---

---

---

---

---

---

---

# PART I — PERFORMANCE CHECK

## Introduction

The following procedure checks the performance of the 454A without removing the covers or making internal adjustments. All tolerances given in this procedure are based on Section I of this manual.

## Index to Part I — Performance Check

### DISPLAY and Z-AXIS CHECK

- |  |          |
|--|----------|
| 1. Check Trace Alignment               | Page 5-7 |
| 2. Check Astigmatism                   | Page 5-7 |
| 3. Check Y Axis Alignment and Geometry | Page 5-7 |
| 4. Check External Z Axis Operation     | Page 5-7 |

### VERTICAL SYSTEM CHECK

- |  |           |
|--|-----------|
| 5. Check Channel 1 and 2 Step Attenuator Balance             | Page 5-9  |
| 6. Check Channel 1 and 2 Gain                                | Page 5-9  |
| 7. Check Added Mode Operation                                | Page 5-10 |
| 8. Check Channel 1 and 2 Deflection Accuracy                 | Page 5-10 |
| 9. Check Channel 1 and 2 Variable Volts/Division Range       | Page 5-10 |
| 10. Check Channel 1 and 2 Cascaded Deflection Factor         | Page 5-10 |
| 11. Check Alternate Operation                                | Page 5-11 |
| 12. Check Chopped Operation                                  | Page 5-11 |
| 13. Check Upper Vertical Bandwidth Limit of Channels 1 and 2 | Page 5-11 |
| 14. Check Added Mode Bandwidth                               | Page 5-12 |
| 15. Check Channel 1 and 2 Cascaded Upper Bandwidth Limit     | Page 5-13 |
| 16. Check Common-Mode Rejection Ratio                        | Page 5-13 |
| 17. Check Amplifier Crosstalk                                | Page 5-13 |
| 18. Check Bandwidth Limiter Operation                        | Page 5-14 |

### TRIGGER SYSTEM CHECK

- |  |           |
|--|-----------|
| 19. Check A and B Low-Frequency Triggering Operation | Page 5-15 |
| 20. Check A and B 150 Megahertz Triggering Operation | Page 5-16 |
| 21. Check A and B 60 Hertz Triggering Operation      | Page 5-17 |
| 22. Check A and B Slope Switch Operation             | Page 5-17 |
| 23. Check Single Sweep Operation                     | Page 5-18 |
| 24. Check A and B Triggering Level Control Range     | Page 5-18 |
| 25. Check Auto Recovery Time and Operation           | Page 5-19 |

### HORIZONTAL SYSTEM CHECK

- |   |           |
|---|-----------|
| 26. Check A and B Sweep Timing Accuracy               | Page 5-20 |
| 27. Check A and B Magnified Sweep Accuracy            | Page 5-21 |
| 28. Check Delay Time Accuracy                         | Page 5-22 |
| 29. Check Delay Time Multiplier Incremental Linearity | Page 5-23 |
| 30. Check Delay-Time Jitter                           | Page 5-24 |
| 31. Check Mixed Sweep Operation                       | Page 5-24 |
| 32. Check A Sweep Length                              | Page 5-24 |
| 33. Check B Ends A Operation                          | Page 5-24 |
| 34. Check A and B Variable Control Range              | Page 5-24 |
| 35. Check X Gain                                      | Page 5-25 |
| 36. Check X-Y Phasing                                 | Page 5-25 |
| 37. Check X Bandwidth in X-Y Mode                     | Page 5-26 |

### OUTPUT SIGNALS CHECK

- |                                      |           |
|--------------------------------------|-----------|
| 38. Check Calibrator Repetition Rate | Page 5-27 |
|--------------------------------------|-----------|

Performance Check—454A/R454A

- 39. Check Calibrator Waveform Risetime     Page 5-27
- 40. Check Calibrator Voltage Output     Page 5-27
- 41. Check Current Through Current  
Probe Cal Loop     Page 5-28
- 42. Check A and B + Gate Output Signals     Page 5-28
- 43. Check A Sweep Output Signal     Page 5-28

Preliminary Procedure for Performance Check

NOTE

*The performance of this instrument can be checked at any temperature within the 0°C to +40°C temperature range unless stated otherwise.*

1. Connect the 454A to a power source which meets the voltage and frequency requirements of this instrument.
2. Set the controls as given under Preliminary Control Settings. Allow at least 20 minutes warmup before proceeding.

**NOTES**

---

---

---

---

---

---

---

---

---

---

---

---

---

---

---

---

---

---

---

---

---

---

---

---

For Service Manuals Contact  
 Tel: 0151 606 1400  
 Email: [service@metrom.com](mailto:service@metrom.com)



## DISPLAY and Z-AXIS CHECK

### Equipment Required

- |  |                                       |
|--|---------------------------------------|
| 1. Type 2901 Time-Mark Generator                                 | 5. 50 $\Omega$ In-Line GR Termination |
| 2. Type 191 Medium-Frequency Constant-Amplitude Signal Generator | 6. BNC T-Connector                    |
| 3. 42-inch 50 $\Omega$ BNC cable                                 | 7. BNC-To-Alligator Clip Adapter      |
| 4. Five-Nanosecond GR Cable                                      | 8. Three-Inch Screwdriver             |

### Control Settings

Set the instrument controls to the settings given under Preliminary Control Settings.

#### 1. Check Trace Alignment

- a. Advance the INTENSITY control until the trace is visible.
- b. Turn the CH 1 POSITION control to move the trace to the center horizontal line.
- c. Adjust the FOCUS control for as sharp a display as possible.
- d. CHECK—The trace should be parallel with the center line.
- e. If necessary, adjust the TRACE ROTATION adjustment, (on side panel) so the trace is parallel to the horizontal graticule lines.

#### 2. Check Astigmatism

- a. Connect the 2901 Time-Mark Generator to the INPUT CH 1 connector with the 42-inch BNC cable.
- b. Set the time-mark generator for output markers of 1 and 0.1 millisecond.
- c. Set the CH 1 VOLTS/DIV switch so the large markers extend beyond the bottom and top of the graticule area.

- d. Set the A LEVEL control for a stable display.

- e. CHECK—Markers should be well defined with optimum setting of the FOCUS control.

- f. If necessary, adjust the FOCUS control and ASTIG adjustment (on side panel) for best definition of markers.

#### 3. Check Y Axis Alignment and Geometry

- a. Set the horizontal POSITION control to move a large marker to the center vertical line.
- b. CHECK—Marker parallel to the center vertical line within 0.1 division.
- c. Set the horizontal POSITION and A VARIABLE controls so a large marker coincides with each vertical graticule line.
- d. CHECK—Bowing and tilt of markers over entire display area within 0.1 division or less.
- e. Disconnect all test equipment.
- f. CALIBRATION—See steps 10 and 11 of Adjustment procedure.

#### 4. Check External Z Axis Operation

- a. Change the following control settings:

A SOURCE	EXT
A and B TIME/DIV	20 $\mu$ s



## VERTICAL SYSTEM CHECK

### Equipment Required

- |   |                                       |
|---|---------------------------------------|
| 1. High-frequency Constant-Amplitude Signal Generator (067-0532-01) | 6. GR 50 $\Omega$ In-Line Termination |
| 2. Medium-Frequency Constant-Amplitude Signal Generator (Type 191)  | 7. Dual-Input Coupler                 |
| 3. Standard Amplitude Calibrator (067-0502-01)                      | 8. 18-Inch 50 $\Omega$ BNC Cable      |
| 4. 5 Nanosecond GR Cable  | 9. 42-Inch 50 $\Omega$ BNC Cable      |
| 5. Two GR 10X attenuators   | 10. Three-Inch Screwdriver            |

### Control Settings

Preset instrument controls to the settings given under Preliminary Control Settings.

### 5. Check Channel 1 and 2 Step Attenuator Balance

a. Position the trace to the center horizontal line with the CH 1 POSITION control.

b. Change the Input Coupling switches to GND.

c. CHECK—Change the CH 1 VOLTS/DIV switch from 10 mV to 2 mV. Trace should not move more than 0.1 division vertically at each step.

d. If there is trace shift, adjust the CH 1 STEP ATTEN BAL adjustment (on front panel) for no trace shift as the CH 1 VOLTS/DIV switch is changed from 10 mV to 2 mV.

#### NOTE

*Use the BANDWIDTH-BEAM FINDER switch to locate the trace if it is deflected off screen when switching to 5 mV or 2 mV.*

e. Set the MODE switch to CH 2.

f. Position the trace to the center horizontal line with the CH 2 POSITION control.

g. CHECK—Change the CH 2 VOLTS/DIV switch from 10 mV to 2 mV. Trace should not move more than 0.1 division vertically at each step.

h. If there is trace shift, adjust the CH 2 STEP ATTEN BAL adjustment (on front panel) for no trace shift as the CH 2 VOLTS/DIV switch is changed from 10 mV to 2 mV.

### 6. Check Channel 1 and 2 Gain

a. Change the CH 1 and CH 2 VOLTS/DIV switches to 20 mV and the MODE switch to CH 1.

b. Connect the standard amplitude calibrator (067-0502-01) output connector to the INPUT CH 1 and INPUT CH 2 connectors through a 42 inch 50  $\Omega$  BNC cable and a dual-input coupler.

c. Set the standard amplitude calibrator for a 0.1-volt square-wave output.

d. CHECK—CRT display for five divisions of deflection.

e. If necessary, adjust the CH 1 GAIN adjustment (on front panel) for exactly five divisions of deflection.

f. Set the MODE switch to ADD.

g. Pull the INVERT switch.

h. Center the display with the CH 2 POSITION control.

**Performance Check—454A/R454A**

i. CHECK—CRT display for straight line.

j. If necessary, adjust the CH 2 GAIN adjustment (on front panel) for straight line.

**7. Check Added Mode Operation**

a. Push the INVERT switch in.

b. Set the standard amplitude calibrator for a 50 millivolt square-wave output.

c. CHECK—CRT display five divisions,  $\pm 0.15$  division in amplitude (within 3%).

**8. Check Channel 1 and 2 Deflection Accuracy**

a. Set the MODE switch to CH 1.

b. Set the CH 2 Input Coupling switch to GND.

c. CHECK—Using the CH 1 VOLTS/DIV switch and standard amplitude calibrator settings given in Table 5-1, check vertical deflection factor within 3% in each position of the CH 1 VOLTS/DIV switch.

d. Set the MODE switch to CH 2.

e. Set the CH 1 Input Coupling switch to GND and the CH 2 Input Coupling switch to DC.

f. CHECK—Using the CH 2 VOLTS/DIV switch and standard amplitude calibrator settings given in Table 5-1, check the vertical deflection factor within 3% in each position of the CH 2 VOLTS/DIV switch.

**9. Check Channel 1 and 2 Variable Volts/Division Range**

a. Set the standard amplitude calibrator for a 0.1-volt square-wave output.

b. Change the CH 1 and CH 2 VOLTS/DIV switches to 20 mV.

c. CHECK—Turn the CH 1 VARIABLE control clockwise just past the CAL detent (minimum gain). Display should be reduced to two divisions or less (indicates adequate range for continuously variable deflection factors between the calibrated steps); CH 1 UNCAL light must be on when CH 1 VARIABLE control is not in CAL position.

d. Set the MODE switch to CH 2.

e. CHECK—Turn the CH 2 VARIABLE control clockwise just past the CAL detent (minimum gain). Display should be reduced to two divisions or less (indicates adequate range for continuously variable deflection factors between calibrated steps). CH 2 UNCAL light must be on when CH 2 VARIABLE control is not in CAL position.

f. Disconnect the cable from the INPUT CH 2 connector.

**10. Check Channel 1 and 2 Cascaded Deflection Factor**

a. Connect the CH 1 OUT connector to the INPUT CH 2 connector with the 18-inch 50-ohm BNC cable.

b. Change the CH 1 and CH 2 VOLTS/DIV switches to 2 mV.

c. Set the standard amplitude calibrator for a two-millivolt square-wave output.

d. Connect the standard amplitude calibrator output to the CH 1 Input connector by a 42-inch 50  $\Omega$  BNC cable.

**TABLE 5-1**

**Vertical Deflection Accuracy**

VOLTS/DIV Switch Setting	Standard Amplitude Calibrator Output	Vertical Deflection in Divisions	Maximum Error For $\pm 3\%$ Accuracy (divisions)
2 mV	10 millivolts	5	$\pm 0.15$
5 mV	20 millivolts	4	$\pm 0.12$
10 mV	50 millivolts	5	$\pm 0.15$
20 mV	0.1 volt	5	Previously set in step 6
50 mV	0.2 volt	4	$\pm 0.12$
.1	0.5 volt	5	$\pm 0.15$
.2	1 volt	5	$\pm 0.15$
.5	2 volts	4	$\pm 0.12$
1	5 volts	5	$\pm 0.15$
2	10 volts	5	$\pm 0.15$
5	20 volts	4	$\pm 0.12$

e. CHECK—CRT display five divisions or greater in amplitude (400  $\mu$ V/division, or less, minimum deflection factor).

f. Disconnect all test equipment.

## 11. Check Alternate Operation

a. Set the MODE switch to ALT.

b. Position the traces about two division apart.

c. Turn the A TIME/DIV switch throughout its range.

d. CHECK—Trace alternation between Channel 1 and 2 at all sweep rates. At faster sweep rates, alternation will not be apparent; display will appear as two traces on the screen.

## 12. Check Chopped Operation

a. Set the Vertical MODE switch to CHOP, the INT TRIG switch to NORM, the HORIZ DISPLAY switch to A, the A TRIGGERING LEVEL control to 0, and the A TIME/DIV switch to .2  $\mu$ s.

b. Position the two traces about 4 divisions apart.

c. CHECK—Duration of each cycle of the chopped waveform is about five divisions (see Fig. 5-1).

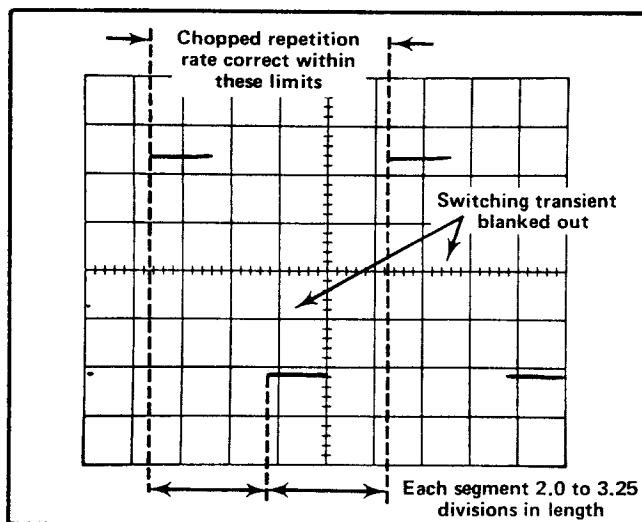

Fig. 5-1. Typical CRT display when checking chopped repetition rate and blanking.

d. CHECK—Length of each segment is between 2.0 and 3.25 divisions (400 to 650 nanoseconds; see Fig. 5-1).

e. CHECK—CRT display for complete blanking of switching transients between chopped segments (see Fig. 5-1).

## 13. Check Upper Vertical Bandwidth Limit of Channels 1 and 2

a. Set the Vertical MODE switch to CH 1, the input coupling switches to DC, the VOLTS/DIV switches to 10 mV, the HORIZ DISPLAY switch to A, the A TIME/DIV switch to .5 ms, and the A TRIGGERING LEVEL control fully clockwise.

b. Connect the output of the high-frequency constant-amplitude signal generator (067-0532-01) to the CH 1 input connector through a GR 10X attenuator and a GR 50  $\Omega$  in-line termination.

c. Adjust the high-frequency signal generator for 4 divisions of deflection at 3.0 megahertz reference.

d. Without changing the signal generator output amplitude, change the output frequency until the vertical deflection is reduced to 2.8 divisions.

e. CHECK—Output frequency of generator must be 150 megahertz or higher.

f. Set the CH 1 VOLTS/DIV switch to 5 mV and add another GR 10X attenuator to the one already in.

g. Adjust the high-frequency generator for 4 divisions of deflection at 3.0 megahertz reference.

h. Without changing the signal generator output amplitude, change the output frequency until the vertical deflection is reduced to 2.8 divisions.

i. CHECK—Output frequency of generator must be 100 megahertz or higher.

j. Change the vertical MODE switch to CH 2.

k. Remove one GR 10X attenuator and adjust the high-frequency generator for 4 divisions of deflection at 3.0 megahertz reference.

## Performance Check—454A/R454A

l. Without changing the signal generator output amplitude, change the output frequency until the vertical deflection is reduced to 2.8 divisions.

m. CHECK—Output frequency of generator must be 150 megahertz or higher.

n. Change the CH 2 VOLTS/DIV switch to 5 mV and add another 10X GR attenuator to the one already there connected.

o. Adjust the high-frequency signal generator for 4 divisions of deflection at 3.0 megahertz reference.

p. Without changing the signal generator output amplitude, change the output frequency until the vertical deflection is reduced to 2.8 divisions.

q. CHECK—Output frequency of generator must be 100 megahertz or higher.

r. Using the high-frequency constant-amplitude signal generator, repeat bandwidth checks in the 20 mV and 50 mV positions of both the CH 1 and CH 2 VOLTS/DIV switches. Upper Bandwidth limit frequency must be 150 megahertz or higher.

s. Replace the high-frequency constant-amplitude signal generator (067-0532-01) with the medium-frequency constant-amplitude signal generator (Type 191).

t. Connect the output of the Type 191 to the CH 2 input connector through a 5 nanosecond cable and a GR 50  $\Omega$  in-line termination.

u. Change the CH 2 VOLTS/DIV switch to 2 mV.

v. Adjust the medium-frequency signal generator for 4 divisions of deflection at 50 kHz reference.

w. Without changing the signal generator output amplitude, change the output frequency until the vertical deflection is reduced to 2.8 divisions.

x. CHECK—Output frequency of generator must be 50 megahertz or higher.

y. Change the vertical MODE switch to CH 1 and the CH 1 VOLTS/DIV switch to 2 mV.

z. Adjust the medium-frequency signal generator for 4 divisions of deflection at 50 kHz reference.

aa. Without changing the signal generator output amplitude, change the output frequency until the vertical deflection is reduced to 2.8 divisions.

ab. CHECK—Output frequency of generator must be 50 megahertz or higher.

ac. Disconnect all test equipment.

ad. CALIBRATION—See steps 20, 21, and 22 of Adjustment procedure.

## 14. Check Added Mode Bandwidth

a. Set the vertical MODE switch to ADD and the CH 1 and CH 2 VOLTS/DIV switches to 10 mV.

b. Set the CH 1 input coupling switch to DC and the CH 2 input coupling switch to GND.

c. Connect the output of the high-frequency constant-amplitude signal generator (067-0532-01) to the CH 1 input connector through a 5 nanosecond cable, a GR 10X attenuator, and a GR 50  $\Omega$  in-line termination.

d. Adjust the high-frequency generator for 4 divisions of deflection at 3.0 megahertz reference.

e. Without changing the signal generator output amplitude, change the output frequency until the vertical deflection is reduced to 2.8 divisions.

f. CHECK—Output frequency of generator must be 140 megahertz or higher.

g. Change the CH 1 input coupling switch to GND and the CH 2 input coupling switch to DC.

h. Apply the output signal from the high-frequency signal generator to the CH 2 input connector.

i. Adjust the high-frequency generator for 4 divisions of deflection at 3.0 megahertz reference.

j. Without changing the signal generator output amplitude, change the output frequency until the vertical deflection is reduced to 2.8 divisions.

k. CHECK—Output frequency of generator must be 140 megahertz or higher.

l. Disconnect all test equipment.

### 15. Check Channel 1 and 2 Cascaded Upper Bandwidth Limit

a. Connect the CH 1 OUT connector to the CH 2 input connector with an 18-inch 50  $\Omega$  BNC cable.

b. Set the vertical MODE switch to CH 2 and the CH 1 and CH 2 VOLTS/DIV switches set to 2 mV.

c. Make sure the INT TRIG switch is set to NORM.

d. Connect the output of the medium-frequency constant-amplitude signal generator to the CH 1 input connector through a 5 nanosecond cable, a GR 10X attenuator and a GR 50  $\Omega$  in-line termination.

e. Adjust the medium-frequency generator for 4 divisions of deflection at 50 kHz reference.

f. Without changing the signal generator output amplitude, change the output frequency until the vertical deflection is reduced to 2.8 divisions.

g. CHECK—Output frequency of generator must be 33 megahertz or higher.

h. Remove the 18-inch 50  $\Omega$  BNC cable from the instrument.

### 16. Check Common-Mode Rejection Ratio

a. Set the CH 1 and CH 2 VOLTS/DIV switches to 10 mV and the vertical MODE switch to CH 1.

b. Connect the output of the medium-frequency constant-amplitude signal generator to the CH 1 and CH 2 input connectors through the 5 nanosecond cable, a GR 50  $\Omega$  in-line termination and a dual-input coupler.

c. Adjust the medium-frequency signal generator for 8 divisions of deflection at 50 kHz reference.

d. Set the vertical MODE switch to ADD and pull the INVERT switch out.

e. Adjust the Channel 2 GAIN adjustment (on the front panel) for minimum deflection (optimum common-mode rejection).

f. Without changing the medium-frequency generator output amplitude, change the output frequency to 20 megahertz.

g. CHECK—CRT display for 0.4 division of deflection or less (common-mode rejection of 20:1 or better).

h. Readjust Channel 2 GAIN adjust if necessary in the manner given in Performance Check step 6.

### 17. Check Amplifier Crosstalk

a. Remove the dual-input coupler and apply the medium-frequency signal generator output to the CH 2 input connector through a 5 nanosecond cable and a GR 50  $\Omega$  in-line termination.

b. Set the vertical MODE switch to CH 2 and the CH 2 VOLTS/DIV switch to .2.

c. Push the INVERT switch in.

d. Adjust the medium-frequency signal generator for 2 divisions of deflection of 50 MHz signal.

e. Change the CH 1 and CH 2 VOLTS/DIV switches to 20 mV and the vertical MODE switch to CH 1.

f. CHECK—CRT display for 0.2 division deflection or less (amplifier crosstalk ratio 100:1 or better).

g. Disconnect the 50  $\Omega$  in-line termination from the CH 2 input connector and reconnect it to the CH 1 input connector.

h. Change the vertical MODE switch to CH 2.

i. CHECK—CRT display for 0.2 division deflection or less (amplifier crosstalk ratio 100:1 or better).

### 18. Check Bandwidth Limiter Operation

a. Set the vertical MODE switch to CH 1 and the BANDWIDTH-BEAM FINDER switch to 20 MHz.

b. Adjust the medium-frequency signal generator for 6 divisions of deflection at 50 kHz reference.

c. Without changing the signal generator output amplitude, change the output frequency until the vertical deflection is reduced to 4.2 divisions.

d. CHECK—Output frequency of 16 to 24 megahertz.

e. Increase the output frequency of the medium-frequency signal generator to 100 megahertz.

f. CHECK—CRT display for 0.2 division or less deflection (attenuation ratio of 30:1 or better of 100 megahertz signal).

g. Disconnect all test equipment.

### NOTES

---

---

---

---

---

---

---

---

---

---

---

---

---

---

---

---

---

---

---

---

---

---

---

---

---

---

---

---

---

---

For Service Manual Contact  
MAY 2005  
8  
Tel: +44 (0)1473 20954  
E-mail: [service@hifon.co.uk](mailto:service@hifon.co.uk)





## TRIGGER SYSTEM CHECK

### Equipment Required

- |   |   |
|---|---|
| 1. High-Frequency Constant-Amplitude Signal Generator (067-0532-01) | 7. GR 5 Nanosecond Cable                |
| 2. Medium-Frequency Constant-Amplitude Signal Generator (Type 191)  | 8. Two 42-inch 50 $\Omega$ BNC Cables   |
| 3. Low-Frequency Signal Generator (General Radio 1310-A)            | 9. 18-inch 50 $\Omega$ BNC Cable        |
| 4. Time-Mark Generator (Type 2901)                                  | 10. GR 50 $\Omega$ In-Line Termination  |
| 5. CT-3 Signal Pickoff  | 11. BNC 50 $\Omega$ In-Line Termination |
| 6. 10X Probe  | 12. GR 50 $\Omega$ 10X Attenuator       |
|   | 13. BNC T-Connector                     |

### Control Settings

Preset instrument controls to the settings given under Preliminary Control Settings.

### 19. Check A and B Low-Frequency Triggering Operation

a. Connect the output of the medium-frequency constant-amplitude signal generator (Type 191) to the CH 1 input connector through a 5 nanosecond cable, a GR 50  $\Omega$  in-line termination and a BNC T-connector.

b. Connect an 18-inch 50  $\Omega$  BNC cable from the unused end of the BNC T-connector to the A EXT TRIG INPUT connector.

c. Set the CH 1 VOLTS/DIV switch to 1, the A and B TRIGGERING LEVEL controls fully clockwise and the A and B TIME/DIV switches to 20  $\mu$ s.

d. Adjust the medium-frequency signal generator for 0.3 division of deflection of the 50 kHz reference signal.

e. CHECK—That a stable display can be obtained by adjusting the A TRIGGERING LEVEL control in both the + and – positions of the TRIGGERING SLOPE switch. Repeat check for each position of the TRIGGERING COUPLING switch.

f. Set the A TRIGGERING SOURCE switch to EXT.

g. CHECK—Repeat check step e. Must be able to trigger both + and – in all positions of the TRIGGERING COUPLING switch.

h. Set the HORIZ DISPLAY switch to B (DELAYED SWEEP).

i. CHECK—That a stable display can be obtained by adjusting the A TRIGGERING LEVEL control in both the + and – positions of the TRIGGERING SLOPE switch. Repeat check for each position of the TRIGGERING COUPLING switch.

j. Remove the 18-inch 50  $\Omega$  BNC cable from the A EXT TRIG INPUT connector and re-install it on the B EXT TRIG INPUT connector.

k. Set the B TRIGGERING SOURCE switch to EXT.

l. CHECK—Repeat check step i. Must be able to trigger both + and – in all positions of the TRIGGERING COUPLING switch.

m. Increase the output frequency of the medium-frequency signal generator to 20 megahertz.

## Performance Check—454A/R454A

- n. Set the A and B TIME/DIV switches to  $.1 \mu\text{s}$ .
- o. CHECK—That a stable display can be obtained by adjusting the B TRIGGERING LEVEL control in both the + and – positions of the TRIGGERING SLOPE switch. Repeat check for each position of the TRIGGERING COUPLING switch. Stable display must not be obtainable in the HF REJ position of the TRIGGERING COUPLING switch.
- p. Set the B TRIGGERING SOURCE switch to INT.
- q. CHECK—Repeat check step o. Triggering, both + and –, must be possible in all positions of the B TRIGGERING COUPLING switch except the HF REJ position.
- r. Set the HORIZ DISPLAY switch to A.
- s. Remove the 18-inch  $50 \Omega$  BNC cable from the B EXT TRIG INPUT connector and re-install it on the A EXT TRIG INPUT connector.
- t. CHECK—That a stable display can be obtained by adjusting the A TRIGGERING LEVEL control in both the + and – positions of the TRIGGERING SLOPE switch. Repeat check for each position of the TRIGGERING COUPLING switch. Stable display must not be obtainable in the HF REJ position of the TRIGGERING COUPLING switch.
- u. Set the A TRIGGERING SOURCE switch to INT.
- v. CHECK—Repeat check step t. Triggering, both + and –, must be possible in all positions of the A TRIGGERING COUPLING switch except the HF REJ position.
- w. Disconnect all test equipment.
- x. CALIBRATION—See step 24 of Adjustment procedure.
- TIME/DIV switches to  $.02 \mu\text{s}$ , the MAG switch to X10 and the A and B TRIGGERING LEVEL controls fully clockwise.
- c. Adjust the high-frequency signal generator for 1.5 divisions of deflection of a 150 megahertz signal.
- d. CHECK—That a stable display can be obtained by adjusting the A TRIGGERING LEVEL and HF STAB controls in both the + and – positions of the TRIGGERING SLOPE switch. Repeat check for each position of the TRIGGERING COUPLING switch. A stable display must not be obtainable in the HF REJ position of the TRIGGERING COUPLING switch.
- e. CHECK—CRT display for  $.2$  division or less of jitter.
- f. Set the HORIZ DISPLAY switch to B (DELAYED SWEEP).
- g. CHECK—That a stable display can be obtained by adjusting the B TRIGGERING LEVEL and the A HF STAB controls in both the + and – positions of the TRIGGERING SLOPE switch. Repeat check for each position of the TRIGGERING COUPLING switch. A stable display must not be obtainable in the HF REJ position of the TRIGGERING COUPLING switch.
- h. Disconnect all test equipment.
- i. Connect the output of the high-frequency signal generator to the CH 1 input connector through a GR 10X attenuator, a CT-3 Signal Pickoff and a GR  $50 \Omega$  in-line termination. Connect an 18-inch  $50 \Omega$  BNC cable to the trigger pickoff connector of the CT-3, and terminate the end of the 18-inch cable with a BNC  $50 \Omega$  in-line termination.
- j. Set the HORIZ DISPLAY switch to A and the A and B TRIGGERING LEVEL controls fully clockwise.
- k. Adjust the high-frequency signal generator for 3.75 divisions of deflection (375 mV) of 3 megahertz reference signal.

## 20. Check A and B 150 Megahertz Triggering

- a. Connect the output of the high-frequency constant-amplitude signal generator (067-0532-01) to the CH 1 input connector through a GR 10X attenuator and a GR  $50 \Omega$  in-line termination.
- b. Set the CH 1 VOLTS/DIV switch to  $.1$ , the A and B TRIGGERING SOURCE switches to INT, the A and B
- l. Without changing the output amplitude of the high-frequency signal generator, change the output frequency to 150 megahertz.
- m. Remove the GR  $50 \Omega$  in-line termination from the CH 1 input connector and re-install it on the A EXT TRIG INPUT connector.

n. Connect the BNC 50  $\Omega$  in-line termination on the end of the 18-inch BNC cable to the CH 1 input connector.

o. Set the A and B TRIGGERING SOURCE switches to EXT.

p. CHECK—That a stable display can be obtained by adjusting the A TRIGGERING LEVEL and HF STAB controls in both the + and – positions of the TRIGGERING SLOPE switch. Repeat check for each position of the TRIGGERING COUPLING switch. A stable display must not be obtainable in the HF REJ position of the TRIGGERING COUPLING switch.

q. CHECK—CRT display for 0.2 division or less of jitter.

r. Set the A TRIGGERING SOURCE switch to INT and the CH 1 VOLTS/DIV switch to 10 mV.

s. Adjust the A TRIGGERING LEVEL and HF STAB controls for as stable a display as possible.

t. Remove the GR 50  $\Omega$  in-line termination from the A EXT TRIG INPUT connector and re-install it on the B EXT TRIG INPUT connector.

u. Set the HORIZ DISPLAY switch to B (DELAYED SWEEP) and the B TRIGGERING SOURCE switch to EXT.

v. CHECK—That a stable display can be obtained by adjusting the B TRIGGERING LEVEL and A HF STAB controls in both the + and – positions of the TRIGGERING SLOPE switch. Repeat check for each position of the TRIGGERING COUPLING switch. A stable display must not be obtainable in the HF REJ position of the TRIGGERING COUPLING switch.

w. CHECK—CRT display for 0.2 division or less of jitter.

x. Disconnect all test equipment.

## 21. Check A and B 60 Hz Triggering Operation

a. Connect a 10X probe to the CH 1 input connector.

b. Set the HORIZ DISPLAY switch to A, the A and B TIME/DIV switches to 5 ms, the MAG switch to OFF, the

A and B TRIGGERING SOURCE switches to INT and the CH 1 VOLTS/DIV switch to 5.

c. Connect the 10X probe tip to a line-voltage source.

d. CHECK—That a stable display can be obtained by adjusting the A TRIGGERING LEVEL control in both the + and – positions of the TRIGGERING SLOPE switch. Repeat check for each position of the TRIGGERING COUPLING switch. A stable display must not be obtainable in the LF REJ position of the TRIGGERING COUPLING switch.

e. Set the A TRIGGERING SOURCE switch to LINE.

f. CHECK—Repeat check step d. Triggering, + and –, must be possible in all positions of the TRIGGERING COUPLING switch except LF REJ.

g. Set the HORIZ DISPLAY switch to B (DELAYED SWEEP).

h. CHECK—That a stable display can be obtained by adjusting the B TRIGGERING LEVEL control in both the + and – positions of the TRIGGERING SLOPE switch. Repeat check for each position of the TRIGGERING COUPLING switch. A stable display must not be obtainable in the LF REJ position of the TRIGGERING COUPLING switch.

i. Set the B TRIGGERING SOURCE switch to LINE.

j. CHECK—Repeat check step h. Triggering, + and –, must be possible in all positions of the TRIGGERING COUPLING switch except LF REJ.

k. Disconnect all test equipment.

## 22. Check A and B Slope Switch Operation

a. Connect the output of low-frequency signal generator (General Radio 1310-A) to the CH 1 input connector through a 42-inch 50  $\Omega$  BNC cable.

b. Set the HORIZ DISPLAY switch to A, the A and B TIME/DIV switches to 1 ms, the A and B TRIGGERING SOURCE switches to INT, the A and B TRIGGERING SLOPE switches to + and the A and B TRIGGERING LEVEL controls to 0.

## Performance Check—454A/R454A

- c. Adjust the low-frequency signal generator for a 4 division display of 1 kHz signal.
- d. CHECK—CRT display starts on the positive slope of the waveform.
- e. Set the A TRIGGERING SLOPE switch to —.
- f. CHECK—CRT display starts on the negative slope of the waveform.
- g. Set the HORIZ DISPLAY switch to B (DELAYED SWEEP).
- h. CHECK—CRT display starts on the positive slope of the waveform.
- i. Set the B TRIGGERING SLOPE switch to —.
- j. CHECK—CRT display starts on the negative slope of the waveform.

## 23. Check Single Sweep Operation

- a. Set the HORIZ DISPLAY switch to A and the A TRIGGERING SLOPE switch to +.
- b. If necessary, adjust the A TRIGGERING LEVEL control for a stable display.
- c. Set the A SWEEP MODE switch to SINGLE SWEEP.
- d. Disconnect the signal from the CH 1 input connector.
- e. Press the RESET button.
- f. CHECK—RESET light must come on when button is pressed and remain on until signal is re-applied and sweep is completed.
- g. Reconnect the signal to the CH 1 input connector.
- h. CHECK—A single-sweep display (one sweep only) is presented. RESET light must go off at the end of the sweep and remain off until the RESET button is pressed again.

## 24. Check A and B TRIGGERING LEVEL Control Range

- a. Connect the output of the low-frequency signal generator to the CH 1 input connector and the A EXT TRIG INPUT connector through a BNC T-connector and two 42-inch 50  $\Omega$  BNC cables.
- b. Set the HORIZ DISPLAY switch to A, the A and B TRIGGERING SOURCE switches to EXT and the CH 1 VOLTS/DIV switch to 1.
- c. Set the A SWEEP MODE switch to AUTO TRIG.
- d. Adjust the low-frequency signal generator output amplitude for a 4 division display of a 1 kHz signal.
- e. CHECK—Rotate the A TRIGGERING LEVEL control throughout its range and check that display can be triggered at any point along the positive slope of the waveform (indicates A TRIGGERING LEVEL control range of at least + and — 2 volts). Display is not triggered at either extreme of rotation.
- f. Set the A TRIGGERING SLOPE switch to —.
- g. CHECK—Rotate the A TRIGGERING LEVEL control throughout its range and check that display can be triggered at any point along the negative slope of the waveform (indicates A TRIGGERING LEVEL control range of at least + and — 2 volts).
- h. Set the CH 1 VOLTS/DIV switch to 10 and the A TRIGGERING SOURCE switch to EXT  $\div$ 10.
- i. Adjust the low-frequency signal generator output amplitude for a 4 division display of a 1 kHz signal.
- j. CHECK—Rotate the A TRIGGERING LEVEL control throughout its range and check that display can be triggered at any point along the negative slope of the waveform (indicates A TRIGGERING LEVEL control range of at least + and — 20 volts). Display is not triggered at either extreme of rotation.
- k. Set the A TRIGGERING SLOPE switch to +.
- l. CHECK—Rotate the A TRIGGERING LEVEL control throughout its range and check that display can be triggered

at any point along the positive slope of the waveform (indicates A TRIGGERING LEVEL control range of at least + and - 20 volts). Display is not triggered at either extreme of rotation.

m. Set the HORIZ DISPLAY switch to B (DELAYED SWEEP).

n. Remove the BNC cable from the A EXT TRIG INPUT connector and re-install it on the B EXT TRIG INPUT connector.

o. Set the A TRIGGERING SOURCE switch to INT and the B TRIGGERING SOURCE switch to EXT  $\div 10$ .

p. CHECK—Rotate the B TRIGGERING LEVEL control throughout its range and check that display can be triggered at any point along the positive slope of the waveform (indicates B TRIGGERING LEVEL control range of at least + and - 20 volts). Display is not triggered at either extreme of rotation.

q. Set the B TRIGGERING SLOPE switch to -.

r. CHECK—Rotate the B TRIGGERING LEVEL control throughout its range and check that display can be triggered at any point along the negative slope of the waveform (indicates B TRIGGERING LEVEL control range of at least + and - 20 volts). Display is not triggered at either extreme of rotation.

s. Set the CH 1 VOLTS/DIV switch to 1 and the B TRIGGERING SOURCE switch to EXT.

t. Adjust the low-frequency signal generator output amplitude for a 4 division display of a 1 kHz signal.

u. CHECK—Rotate the B TRIGGERING LEVEL control throughout its range and check that display can be triggered

at any point along the negative slope of the waveform (indicates B TRIGGERING LEVEL control range of at least + and - 2 volts). Display is not triggered at either extreme of rotation.

v. Set the B TRIGGERING SLOPE switch to +.

w. CHECK—Rotate the B TRIGGERING LEVEL control throughout its range and check that display can be triggered at any point along the positive slope of the waveform (indicates B TRIGGERING LEVEL control range of at least + and - 2 volts). Display is not triggered at either extreme of rotation

x. Disconnect all test equipment.

## 25. Check Auto Recovery Time and Operation

a. Set the A TIME/DIV switch to 50 ms and the A SWEEP MODE switch to AUTO TRIG.

b. Connect the output of the 2901 Time Mark Generator to the CH 1 input connector through a 42-inch 50  $\Omega$  BNC cable.

c. Set the time mark generator for 50 ms time marker output.

d. CHECK—A stable display can be obtained by adjusting the A TRIGGERING LEVEL control. Marker must be at the start of the sweep.

e. Set the time mark generator for 0.1 second time marker output.

f. CHECK—Sweep free runs and stable display cannot be obtained. If stable display is obtained, marker must not be at the start of the sweep.

For Service Manuals Contact  
**MAURITRON TECHNICAL SERVICES**  
 8 Cherry Tree Rd, Gillingham  
 Oxon OX9 4QY  
 Tel: 01844-351894 Fax: 01844-352554  
 Email: enquires@maurifron.co.uk

**HORIZONTAL SYSTEM CHECK**

**Equipment Required**

- |  |                          |
|--|--------------------------|
| 1. Time-Mark Generator (Type 2901)                                 | 5. GR 5 Nanosecond Cable |
| 2. Medium-Frequency Constant-Amplitude Signal Generator (Type 191) | 6. 42-Inch BNC Cable     |
| 3. Standard Amplitude Calibrator (067-0502-01)                     | 7. 18-Inch BNC Cable     |
| 4. GR 50 Ω In-Line Termination                                     | 8. Dual-Input Coupler    |

**Control Settings**

Preset instrument controls to the settings given under Preliminary Control Settings.

**26. Check A and B Sweep Timing Accuracy**

a. CHECK—Using the A TIME/DIV switch and time-mark generator settings given in Table 5-2, check A sweep timing within 0.24 division, over the middle eight divisions of the display (within 3%).

**NOTE**

*Unless otherwise noted, use the middle eight horizontal divisions when checking timing.*

b. Set the time-mark generator for one-millisecond markers.

c. Set the A TIME/DIV switch to 1 ms.

d. Position the second marker to the first-division vertical line.

e. CHECK—Fourth marker within 0.1 division (within 5%) of the third-division vertical line.

f. Position the third marker to the second-division vertical line.

**TABLE 5-2**  
**A and B Timing Accuracy**

A and B TIME/DIV Switch Setting	Time-Mark Generator Output	CRT Display (markers/division)
.02 μs	10 nanosecond	2
.05 μs	50 nanosecond	1
.1 μs	0.1 microsecond	1
.2 μs	0.1 microsecond	2
.5 μs	0.5 microsecond	1
1 μs	1 microsecond	1
2 μs	1 microsecond	2
5 μs	5 microsecond	1
10 μs	10 microsecond	1
20 μs	10 microsecond	2
50 μs	50 microsecond	1
.1 ms	0.1 millisecond	1
.2 ms	0.1 millisecond	2
.5 ms	0.5 millisecond	1
1 ms	1 millisecond	1
2 ms	1 millisecond	2
5 ms	5 millisecond	1
10 ms	10 millisecond	1
20 ms	10 millisecond	2
50 ms	50 millisecond	1
.1 s	0.1 second	1
.2 s	0.1 second	2
.5 s	0.5 second	1
A Sweep Only		
1 s	1 second	1
2 s	1 second	2
5 s	5 second	1

g. CHECK—Fifth marker within 0.1 division (within 5%) of the fourth-division vertical line.

h. Continue this check for each two-division portion of the sweep within the center eight divisions of the graticule.

i. Set the HORIZ DISPLAY switch to B (DELAYED SWEEP).

j. CHECK—Using the A and B TIME/DIV switch and time-mark generator settings given in Table 5-2, check B sweep timing within 0.25 division over the middle eight divisions of the display (within 3%).

k. Set the time-mark generator for one-millisecond markers.

l. Set the A and B TIME/DIV switch to 1 ms.

m. Position the second marker to the first-division vertical line.

n. CHECK—Fourth marker within 0.1 division (within 5%) of the third-division vertical line.

o. Position the third marker to the second-division vertical line.

p. CHECK—Fifth marker within 0.1 division (within 5%) of the fourth-division vertical line.

q. Continue this check for each two-division portion of the sweep within the center eight divisions of the graticule.

r. CALIBRATION—See steps 26, 27, 30, 31, 32 and 33 of Adjustment procedure.

## 27. Check A and B Magnified Sweep Accuracy

a. Set the MAG switch to X10.

b. CHECK—Using the A TIME/DIV switch and time-mark generator settings given in Table 5-3, check A magnified sweep timing within 0.32 division over the middle eight divisions of the magnified display (within 4%). Note the portions of the total magnified sweep length to be excluded from the measurement. Magnifier light must be on.

### NOTE

Change the CH 1 VOLTS/DIV switch to 50 mV and use the HF STAB control to obtain a stable display of the five-nanosecond markers.

TABLE 5-3

#### A and B Magnified Accuracy

A and B TIME/DIV Switch Setting	Time-Mark Generator Output	CRT Display (Markers/Division)	Portions of total magnified sweep length to exclude from measurement
.02 $\mu$ s	5 nanosecond	1 cycle/ 2 1/2 div	First 25 divisions and all beyond the 100th division
.05 $\mu$ s	5 nanosecond	1	First 10 divisions and all beyond the 100th division
.1 $\mu$ s	10 nanosecond	1	First 5 divisions and all beyond the 100th division.
.2 $\mu$ s	10 nanosecond	2	First 2.5 divisions and all beyond the 100th division.
.5 $\mu$ s	50 nanosecond	1	
1 $\mu$ s	0.1 microsecond	1	
2 $\mu$ s	0.1 microsecond	2	
5 $\mu$ s	0.5 microsecond	1	
10 $\mu$ s	1 microsecond	1	
20 $\mu$ s	1 microsecond	2	
50 $\mu$ s	5 microsecond	1	
.1 ms	10 microsecond	1	
.2 ms	10 microsecond	2	
.5 ms	50 microsecond	1	
1 ms	0.1 millisecond	1	
2 ms	0.1 millisecond	2	
5 ms	0.5 millisecond	1	
10 ms	1 millisecond	1	
20 ms	1 millisecond	2	
50 ms	5 millisecond	1	
.1 s	10 millisecond	1	
.2 s	10 millisecond	2	
.5 s	50 millisecond	1	
1 s	0.1 second	1	
2 s	0.1 second	2	
5 s	0.5 second	1	

## Performance Check—454A/R454A

c. Set the time-mark generator for 0.1-millisecond markers.

d. Set the A TIME/DIV switch to 1 ms.

e. Position the first eight-division portion of the total magnified sweep onto the viewing area.

f. CHECK—One marker each division between first- and ninth-division graticule lines; markers at ninth-division vertical line must be within 0.32 division (within 4%) of the line when the marker at the first-division vertical line is positioned exactly.

g. Repeat this check for each eight-division portion of the total magnified sweep length.

h. Set the horizontal POSITION and FINE controls to midrange.

i. Position a marker to the first-division vertical line.

j. CHECK—Marker within 0.1 division (within 5%) of the third-division vertical line.

k. Position the marker nearest the second-division vertical line to the line.

l. CHECK—Marker within 0.1 division (within 5%) of the fourth-division vertical line.

m. Continue this check for each two-division portion of the displayed sweep within the center eight divisions of the graticule.

n. Set the HORIZ DISPLAY switch to B (DELAYED SWEEP).

o. CHECK—Using the A and B TIME/DIV switch and time-mark generator settings given in Table 5-3, check B magnified sweep timing within 0.32 division over the middle eight divisions of the magnified display (within 4%). Note the portions of the total magnified sweep length to be excluded from the measurement.

### NOTE

Change the CH 1 VOLTS/DIV switch to 50 mV to display the five-nanosecond markers.

p. Set the time-mark generator for 0.1-millisecond markers.

q. Set the A and B TIME/DIV switch to 1 ms.

r. Set the horizontal POSITION and FINE controls to midrange.

s. Position a marker to the first-division vertical line.

t. CHECK—Marker within 0.1 division (within 5%) of the third-division vertical line.

u. Position the marker nearest the second-division vertical line to the line.

v. CHECK—Marker within 0.1 division (within 5%) of the fourth-division vertical line.

w. Continue this check for each two-division portion of the displayed sweep within the center eight divisions of the graticule.

x. CALIBRATION—See step 28 of Adjustment procedure.

## 28. Check Delay Time Accuracy

a. Set the MAG switch to OFF.

b. CHECK—Using the A TIME/DIV switch, B TIME/DIV switch and time-mark generator settings given in Table 5-4, check delayed sweep accuracy within the given tolerance. First set the DELAY-TIME MULTIPLIER dial to 1.00 and rotate the dial until the sweep starts at the top of the second marker. Note the dial reading and then set the dial to 9.00 and rotate slightly until the sweep starts at the top of the tenth marker. DELAY-TIME MULTIPLIER dial setting must be 8.00 divisions higher, + or – the allowable error given in Table 5-4.

### NOTE

Sweep will start at top of third marker at 1.00 and nineteenth marker at 9.00 for sweep rates which are multiples of 2 (e.g., 2  $\mu$ s, 20  $\mu$ s, .2 ms, etc.). If in doubt as to the correct setting of the DELAY-TIME MULTIPLIER dial, set the HORIZ DISPLAY switch to A INTEN DURING B and check which marker is intensified.



**TABLE 5-4**  
Delayed Sweep Accuracy

A TIME/ DIV switch setting	B TIME/ DIV switch setting	Time- Mark Generator Output	Allowable Error for Given Accuracy
.1 $\mu$ s	.02	.1 microsecond	$\pm 12$ minor dial divisions ( $\pm 1.5\%$ )
.2 $\mu$ s	.02	.1 microsecond	
.5 $\mu$ s	.05	.5 microsecond	
1 $\mu$ s	.1 $\mu$ s	1 microsecond	
2 $\mu$ s	.1 $\mu$ s	1 microsecond	
5 $\mu$ s	.5 $\mu$ s	5 microsecond	
10 $\mu$ s	1 $\mu$ s	10 microsecond	
20 $\mu$ s	1 $\mu$ s	10 microsecond	
50 $\mu$ s	5 $\mu$ s	50 microsecond	
.1 ms	10 $\mu$ s	0.1 millisecond	
.2 ms	10 $\mu$ s	0.1 millisecond	
.5 ms	50 $\mu$ s	0.5 millisecond	
1 ms	.1 ms	1 millisecond	
2 ms	.1 ms	1 millisecond	
5 ms	.5 ms	5 millisecond	$\pm 20$ minor dial divisions ( $\pm 2.5\%$ )
10 ms	1 ms	10 millisecond	
20 ms	1 ms	10 millisecond	
50 ms	5 ms	50 millisecond	
.1 s	10 ms	0.1 second	
.2 s	10 ms	0.1 second	
.5 s	50 ms	0.5 second	
1 s	.1 s	1 second	
2 s	.1 s	1 second	
5 s	.5 s	5 second	

### 29. Check Delay Time Multiplier Incremental Linearity

a. Change the following control settings:

DELAY-TIME MULTIPLIER 9.00  
A TIME/DIV 1 ms  
B TIME/DIV 10  $\mu$ s

b. Set the time-mark generator for one-millisecond markers.

#### NOTE

*If there were not exactly 8.00 dial divisions between 1.00 and 9.00 with A TIME/DIV switch set to 1 ms as measured in step 26, use parts c through k to compensate for this error. Then the incremental linearity of the DELAY-TIME MULTIPLIER dial can be read directly from the dial. If the difference was exactly eight divisions, proceed to part m.*

c. Set the A TIME/DIV switch to .5 ms; then return the B TIME/DIV switch to 10  $\mu$ s.

d. Set the HORIZ DISPLAY switch to A.

e. Set the A VARIABLE control for one marker each division between the first- and ninth-division vertical lines.

f. Set the HORIZ DISPLAY switch to B (DELAYED SWEEP).

g. Set the DELAY-TIME MULTIPLIER dial to 1.00 and rotate slightly until a marker is displayed at the start of the sweep. Note the dial reading.

h. Set the DELAY-TIME MULTIPLIER dial exactly 8.00 dial divisions higher than the reading in part g.

i. Turn the A VARIABLE control slightly so a marker is displayed at the start of the sweep.

j. Set the HORIZ DISPLAY switch to A INTEN DURING B and check for nine markers between the DELAY-TIME MULTIPLIER dial positions of 1.00 and 9.00.

k. Return the HORIZ DISPLAY switch to B (DELAYED SWEEP) and repeat parts g through j until the difference between the markers at about 1.00 and 9.00 is exactly 8.00 dial divisions.

l. Set the DELAY-TIME MULTIPLIER dial to 9.00.

m. Rotate the DELAY-TIME MULTIPLIER dial slightly so a marker is displayed at the start of the sweep.

n. Note the exact DELAY-TIME MULTIPLIER dial reading at 9.00.

o. Set the DELAY-TIME MULTIPLIER dial to 8.00.

p. CHECK—Dial reading should be  $8.00 \pm$  two minor dial divisions (within 0.2%). Take into account the basic dial error at 9.00.

q. Repeat check at each major dial division between 8.00 and 1.00.

### 30. Check Delay-Time Jitter

- a. Change the following control settings:

DELAY-TIME MULTIPLIER	1.00
A TIME/DIV	1 ms
B TIME/DIV	1 $\mu$ s
A VARIABLE	CAL

b. Position the pulse near the center of the display area with the DELAY-TIME MULTIPLIER dial.

c. CHECK—Jitter on the leading edge of the pulse should not exceed 0.5 division (1 part in 20,000). Disregard slow drift.

d. Turn the DELAY-TIME MULTIPLIER dial to 9.00 and adjust so the pulse is displayed near the center of the display area.

e. CHECK—Jitter on leading edge of the pulse should not exceed 0.5 division. Disregard slow drift.

### 31. Check Mixed Sweep Operation

a. Set the A TIME/DIV switch to 1 ms and the B TIME/DIV switch to .5 ms.

b. Set the HORIZ DISPLAY switch to A and the DELAY-TIME MULTIPLIER dial to 10.00.

c. CHECK—Timing between the second and the tenth markers. Record any timing error for use in part e.

d. Set the HORIZ DISPLAY switch to MIXED.

e. CHECK—Timing between second and tenth marker within  $0.16 \text{ division} \pm$  the A sweep error noted in part c (within  $2\% \pm$  measured A sweep error).

### 32. Check A Sweep Length

a. Set the HORIZ DISPLAY switch to A and the A TIME/DIV switch to 1 ms.

b. Set the time-mark generator for 1-millisecond markers.

c. Set the A TRIGGERING LEVEL control for a stable display.

d. Move the tenth marker to the center vertical graticule line with the horizontal POSITION control.

e. CHECK—A sweep length must be at least 10 divisions.

f. Reposition the first marker to the left graticule line.

g. Turn the A SWEEP LENGTH control to 4 DIV (not in B ENDS A detent).

h. CHECK—A sweep length must be four divisions or less.

### 33. Check B Ends A Operation

a. Set the A TIME/DIV switch to 1 ms, the B TIME/DIV switch to .1 ms, the B SWEEP MODE switch to B STARTS AFTER DELAY TIME, the HORIZ DISPLAY switch to A INTEN DURING B, and the A SWEEP LENGTH control to B ENDS A.

b. Rotate the DELAY-TIME MULTIPLIER dial throughout its range.

c. CHECK—CRT display ends after the intensified portion at all DELAY-TIME MULTIPLIER dial settings.

### 34. Check A and B Variable Control Range

a. Set the A and B TIME/DIV switches to 1 ms, the HORIZ DISPLAY switch to A and the SWEEP LENGTH control to FULL.

b. Set the time-mark generator for 10 ms time markers.

c. Set the A TRIGGERING LEVEL control for a stable display.

d. Position the markers to the far right and left graticule lines with the horizontal POSITION control.

e. Turn the A VAR control fully counterclockwise.

f. CHECK—CRT display for four divisions maximum spacing between markers (indicates adequate range for continuously variable sweep rate between the calibrated steps). UNCAL A OR B light must be on when A VAR control is not in detent position.

g. Set the A VAR control to the detent position and the A TIME/DIV switch to 2 ms (leave the B TIME/DIV switch in the 1 ms position).

h. Adjust the DELAY-TIME MULTIPLIER dial to position the time markers to the left and right graticule lines.

i. Turn the B TIME/DIV VAR control (on instrument side panel) fully counterclockwise.

j. CHECK—CRT display for four-divisions maximum spacing between markers (indicates adequate range for continuously variable sweep rate between calibrated steps). UNCAL A OR B light must be on when B TIME/DIV VAR control is not in the detent position.

k. Disconnect all test equipment.

### 35. Check X Gain

a. Set the CH 1 and CH 2 VOLTS/DIV switches to 20 mV, the HORIZ DISPLAY switch to X-Y and the INT TRIG switch to CH 1 ONLY OR X-Y.

b. Connect the standard amplitude calibrator (067-0502-01) to the CH 1 OR X connector via a 42-inch 50  $\Omega$  BNC cable.

c. Set the standard amplitude calibrator for a 0.1-volt square-wave output.

d. Increase the INTENSITY control setting until the display (two dots about five divisions apart) is visible.

e. Move the display to the center of the graticule with the CH 1 POSITION control.

f. CHECK—CRT display for five divisions horizontal deflection.

g. If necessary, adjust the X-GAIN adjustment (on side panel) for exactly five divisions horizontal deflection.

h. Disconnect all test equipment.

### 36. Check X-Y Phasing

a. Connect the medium-frequency constant-amplitude sine-wave generator to the INPUT CH 1 and INPUT CH 2

connectors through the five-nanosecond GR cable, 50-ohm in-line termination and the dual-input coupler.

b. Set the CH 1 VOLTS/DIV switch to 10 mV and the CH 2 VOLTS/DIV switch to 20 mV.

c. Set the medium-frequency generator for a 10-division horizontal display at two megahertz.

d. Center the display vertically and horizontally with the CH 1 and CH 2 POSITION controls.

e. CHECK—CRT display for an opening at the center horizontal line of 0.52 division or less ( $3^\circ$  or less phase shift; see Fig. 5-2).

f. Set the medium-frequency generator for a 10 division horizontal display at one megahertz.

g. If necessary, recenter the display with the CH 1 and CH 2 POSITION control.

h. CHECK—CRT display for an opening at the center horizontal line of 0.52 division or less ( $3^\circ$  or less phase shift).

i. Set the constant-amplitude generator for a 10-division horizontal display at 0.5 megahertz.

j. If necessary, recenter the display with the CH 1 and CH 2 POSITION controls.

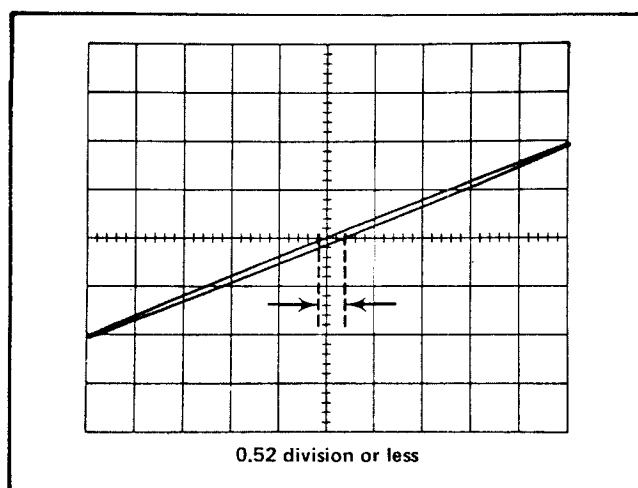

Fig. 5-2. Typical CRT display when checking X-Y phasing.



## OUTPUT SIGNALS CHECK

### Equipment Required

- |  |  |
|--|--|
| <ol style="list-style-type: none"> <li>1. Test Oscilloscope</li> <li>2. Time-Mark Generator (Type 2901)</li> <li>3. Standard Amplitude Calibrator (067-0502-01)</li> </ol> | <ol style="list-style-type: none"> <li>4. Current Probe With Passive Termination (Tektronix Type P6021 With 011-0105-00 Passive Termination).</li> <li>5. 42-Inch 50 <math>\Omega</math> BNC Cable</li> <li>6. 18-Inch 50 <math>\Omega</math> BNC Cable</li> </ol> |
|--|--|

### Control Settings

Preset instrument controls to the settings given in the Preliminary Procedure.

### 38. Check Calibrator Repetition Rate

a. Set the CH 1 and CH 2 VOLTS/DIV switches to .5, the INT TRIG switch to NORM, the A and B TIME/DIV switches to .1 ms and the vertical MODE switch to ALT.

b. Connect 1-millisecond time markers to the CH 2 input connector through a 42-inch 50  $\Omega$  BNC cable.

c. Connect the 1 V CAL 1 kHz connector to the CH 1 connector through an 18-inch 50  $\Omega$  BNC cable.

d. Position the display so the tips of the time markers fall just below the rising portions of the square wave.

e. Using the horizontal POSITION control, set the rising portion of the second calibrator cycle to the center vertical graticule line.

f. Set the MAG Switch to X10.

g. CHECK—Separation between the calibrator waveform leading edge and the time marker leading edge should not exceed 0.5 division (0.5% accuracy).

h. CALIBRATION—See step 6 of Adjustment procedure.

### 39. Check Calibrator Waveform Risetime

a. Set the vertical MODE switch to CH 1, the CH 1 VOLTS/DIV switch to .2, the A TIME/DIV switch to .2  $\mu$ s and the MAG switch to OFF.

b. Set the A TRIGGERING LEVEL control so all of the leading edge of the waveform is visible.

c. Position the 10% point of the leading edge to a vertical graticule line.

d. CHECK—CRT display for five divisions or less between the 10% and 90% points on the leading edge of the calibrator waveform (one microsecond or less, risetime).

e. Disconnect all test equipment.

### 40. Check Calibrator Voltage Output

a. Set the A and B TIME/DIV switch to 5 ms, the CH 1 VOLTS/DIV switch to .1 and the A TRIGGERING SOURCE switch to LINE.

b. Connect the 1 V CAL 1 kHz connector to the unknown input connector of the standard amplitude calibrator (067-0502-01) with a 42-inch 50  $\Omega$  BNC cable.

c. Set the standard amplitude calibrator for a positive, one-volt DC output in the chopped mode.

d. Connect the standard amplitude calibrator output to the INPUT CH 1 connector.

e. Set the A LEVEL control for a stable display.

f. Position the top of the waveform on the display area with the CH 1 POSITION control.

g. CHECK—Difference between the standard amplitude calibrator output level and the 454A calibrator output 0.1 division or less (one volt,  $\pm 1\%$ ).

## Performance Check—454A/R454A

- h. Disconnect all test equipment.
- i. CALIBRATION—See step 2 of Adjustment procedure.

### 41. Check Current through Current Probe Cal Loop

- a. Connect the current-measuring probe and passive termination to the INPUT CH 1 connector.
- b. Set the passive termination for a sensitivity of 2 mA/mV.
- c. Clip the current-measuring probe around the CURRENT PROBE CAL loop.
- d. Set the CH 1 VOLTS/DIV switch to 5 mV, the A TRIGGERING SOURCE switch to INT and the A and B TIME/DIV switches to .5 ms.
- e. CHECK—CRT display 0.5 division in amplitude (five milliamperes).

#### NOTE

*This step checks for the presence of current in the CURRENT PROBE CAL loop. This current will remain within the stated 1% accuracy due to the tolerance of the divider resistors and tolerance of the calibrator output voltage. If it is necessary to verify the accuracy of the calibrator current, use a current measuring meter with an accuracy of at least 0.25%.*

- f. Disconnect all test equipment.

### 42. Check A and B + Gate Output Signals

- a. Set the A and B TIME/DIV switches to 1 ms, the A SWEEP MODE switch to AUTO TRIG, B SWEEP MODE switch to B STARTS AFTER DELAY TIME, and both the A and B TRIGGERING LEVEL controls fully clockwise. Be sure the A SWEEP LENGTH control is set to FULL.

- b. Connect the A + GATE connector (on the instrument side panel) to the test-oscilloscope input connector through a 42-inch 50  $\Omega$  BNC cable.

- c. Set the test-oscilloscope for a vertical deflection factor of 2 volts/division at a sweep rate of two milliseconds/division.

- d. CHECK—Test oscilloscope display for about six divisions of vertical deflection with the bottom of the waveform near zero volts. Gate duration should be about 5.5 divisions (about 11 times the A TIME/DIV switch setting).

- e. Set the A TIME/DIV switch to 2 ms, the B TIME/DIV switch to 1 ms, the HORIZ DISPLAY switch to B (DELAYED SWEEP) and the DELAY-TIME MULTIPLIER dial to 0.10.

- f. CHECK—Test oscilloscope display for six divisions of vertical deflection with the bottom of the waveform near zero volts. Gate duration should be about 5.5 divisions (about 11 times the B TIME/DIV switch setting).

### 43. Check A Sweep Output Signal

- a. Connect the A SWEEP connector (on the instrument side panel) to the test oscilloscope input connector through a 42-inch 50  $\Omega$  BNC cable.

- b. Set the A TIME/DIV switch to 1 ms.

- c. CHECK—Test oscilloscope display for a vertical deflection of approximately 5 divisions with the bottom of the waveform near zero volts. Sweep duration should be about 5.5 divisions (about 11 times the A TIME/DIV switch setting).

This completes the performance check procedure for the 454A. If the instrument has met all performance requirements given in this procedure, it is correctly calibrated and within the specified tolerances.

## PART II – ADJUSTMENT

### Introduction

The following procedure returns the 454A to correct calibration. All limits and tolerances given in this procedure are calibration guides and should not be interpreted as instrument specifications except as specified in Section 1. The actual performance of the instrument may exceed the given limits or tolerances if the instrument meets the Performance Requirements as checked in Part I – Performance Check of this section.

### Index to Part II – Adjustment

#### POWER SUPPLY and CALIBRATOR ADJUSTMENT

- |  |           |
|--|-----------|
| 1. Adjust—12-Volt Power Supply (R1124)                                     | Page 5-31 |
| 2. Adjust +12-Volt Power Supply (Adjust Calibrator Output Voltage) (R1158) | Page 5-31 |
| 3. Adjust +75-Volt Power Supply (R1188)                                    | Page 5-32 |
| 4. Adjust High-Voltage Supply and Check Regulation (R1401)                 | Page 5-32 |
| 5. Check Low-Voltage Power Supply Ripple                                   | Page 5-33 |
| 6. Adjust Calibrator Repetition Rate (T1275)                               | Page 5-33 |

#### DISPLAY and Z-AXIS ADJUSTMENT

- |  |           |
|--|-----------|
| 7. Adjust CRT Grid Bias (R1447)        | Page 5-34 |
| 8. Adjust Trace Alignment (R1480)      | Page 5-34 |
| 9. Adjust Astigmatism (R1489)          | Page 5-34 |
| 10. Adjust Y Axis Alignment (R1485)    | Page 5-34 |
| 11. Adjust CRT Geometry (R1482)        | Page 5-35 |
| 12. Adjust Z Axis Compensation (C1352) | Page 5-35 |

#### VERTICAL SYSTEM ADJUSTMENT

- |   |           |
|---|-----------|
| 13. Adjust Channel 1 and 2 Step Attenuator Balance (R21, R28, R121, R128) | Page 5-36 |
| 14. Adjust Vertical Centering (R334)                                      | Page 5-37 |
| 15. Adjust Channel 1 and 2 Position Centering (R40, R140)                 | Page 5-38 |

- |  |           |
|--|-----------|
| 16. Adjust Vertical Output Amplifier Thermal Compensation (R382) | Page 5-38 |
|--|-----------|

- |  |           |
|--|-----------|
| 17. Adjust Channel 1 and 2 Vertical Pre-amp and Vertical Output Amp Gain (R67, R167, R365) | Page 5-38 |
|--|-----------|

- |   |           |
|---|-----------|
| 18. Adjust Channel 1 VOLTS/DIV Switch Compensation (C5A, C5B, C6A, C6B, C9) | Page 5-39 |
|---|-----------|

- |   |           |
|---|-----------|
| 19. Adjust Channel 2 VOLTS/DIV Switch Compensation (C105A, C105B, C106A, C106B, C109) | Page 5-39 |
|---|-----------|

- |   |           |
|---|-----------|
| 20. Adjust Vertical Output Amplifier High-Frequency Compensation (C353, C426, L394, L494, R353, R394, R417, R419, R426, R494) | Page 5-40 |
|---|-----------|

- |   |           |
|---|-----------|
| 21. Adjust Channel 1 High-Frequency Compensation (C16, C22, C25E, C33, C45, C49G, C49H, C78, C90, R16, R33, R44, R49A, R49G, R49H, R90) | Page 5-41 |
|---|-----------|

- |   |           |
|---|-----------|
| 22. Adjust Channel 2 High-Frequency Compensation (C116, C122, C125E, C133, C145, C149G, C149H, C178, C190, R116, R133, R144, R149A, R149G, R149H, R190) | Page 5-42 |
|---|-----------|

#### TRIGGERING ADJUSTMENT

- |   |           |
|---|-----------|
| 23. Adjust CH 1 OUT DC Level (R52)  | Page 5-44 |
| 24. Adjust A and B Trigger Level Centering (R643, R843)                     | Page 5-44 |
| 25. Adjust Trigger Preamp DC Level and Normal Trigger DC Level (R272, R511) | Page 5-45 |

#### HORIZONTAL SYSTEM ADJUSTMENT

- |   |           |
|---|-----------|
| 26. Adjust Sweep Start and A Sweep Calibration (R743, R943) | Page 5-46 |
| 27. Adjust Normal Gain (R1024)                              | Page 5-47 |
| 28. Adjust Magnified Gain (R1026)                           | Page 5-47 |
| 29. Adjust Magnifier Register (R1031)                       | Page 5-48 |
| 30. Adjust B Sweep Calibration (R932)                       | Page 5-48 |
| 31. Adjust A and B One Microsecond Timing (C740C, C930C)    | Page 5-48 |

Ⓐ

For Service Manuals Contact  
 MAURITRON TECHNICAL SERVICES  
 8 Cherry Tree Rd, Chinnor  
 Oxon OX9 4QY  
 Tel: 01844-351634 Fax: 01844-351554  
 Email: enquiries@mauritron.co.uk

5-29

Adjustment—454A/R454A

- 32. Adjust A and B 0.1 Microsecond Timing (C740A, C930A) Page 5-49
- 33. Adjust A and B High-Speed Timing and Linearity (C740P, C930P, C1074, C1094, C1095, R1095) Page 5-49
- 34. Adjust X Gain (R567) Page 5-50
- 35. Adjust X-Y Phasing (L568, R569) Page 5-50

- 2. Connect the autotransformer to a suitable power source.
- 3. Connect the 454A to the autotransformer output.
- 4. Set the autotransformer output voltage to the center of the voltage range selected by the Line Voltage Selector Assembly.
- 5. Set the controls as given under Preliminary Control Settings (given prior to Part I — Performance Check). Allow at least 20 minutes warmup before proceeding.

Preliminary Procedure For Adjustment

NOTE

This instrument should be adjusted at an ambient temperature of 25°C (±5°C) for best overall accuracy.

- 1. Remove the top and bottom covers from the 454A.

NOTE

Titles for external controls of this instrument are capitalized in this procedure (e.g., INTENSITY). Internal adjustments are initial capitalized only (e.g., High Voltage).

NOTES

---

---

---

---

---

---

---

---

---

---

---

---

---

---

---

---

---

---

---

---

---

---

---

---

---

---

---

---

---

---

For Service Manuals Contact  
 MAURICE B. ...  
 8 Chiswick Green, Uxbridge  
 Oxon OX8 4GJ  
 Tel: 01895 810315 Fax: 01895 810554  
 Email: [service@mauriceb.co.uk](mailto:service@mauriceb.co.uk)





## POWER SUPPLY and CALIBRATOR ADJUSTMENT

### Equipment Required

- |   |                                  |
|---|----------------------------------|
| 1. Variable Autotransformer                             | 5. 2901 Time-Mark Generator      |
| 2. Precision DC Voltmeter (with precision 2 kV divider) | 6. 18-inch 50 $\Omega$ BNC cable |
| 3. Test Oscilloscope                                    | 7. 42-inch 50 $\Omega$ BNC cable |
| 4. 1X Probe   | 8. Three-Inch Screwdriver        |

### Control Settings

Preset instrument controls to the settings given in the Preliminary Procedure.

#### 1. Adjust -12-Volt Power Supply

- a. Change the following control settings:

INTENSITY	Counterclockwise
LEVEL (A and B)	Fully clockwise
A SWEEP MODE	SINGLE SWEEP

b. Connect the precision DC voltmeter between the -12 volt test point on the Low-Voltage Regulator circuit board and chassis ground.

c. CHECK—Meter reading of -12 volts,  $\pm 0.12$  volt.

d. ADJUST— -12 Volts adjustment R1124 (see Fig. 5-3) for -12 volts,  $\pm 0.0032$  volt.

e. INTERACTION—May affect the operation of all circuits within the 454A.

#### 2. Adjust +12-Volt Power Supply

a. Remove Q1275 (located behind swing-out side panel; see Fig. 5-4) from its socket on the Calibrator circuit board.

b. Connect the precision DC voltmeter between the center contact of the 1 V CAL 1 kHz connector and chassis ground.

c. CHECK—Meter reading of +1 volt,  $\pm 0.01$  volt ( $\pm 0.015$  volt if the measurement is being made in the -15°C to +55°C temperature range).

d. ADJUST— +12 Volts adjustment R1158 (see Fig. 5-3) for a meter reading of +1 volt ( $\pm 0.003$  volt).

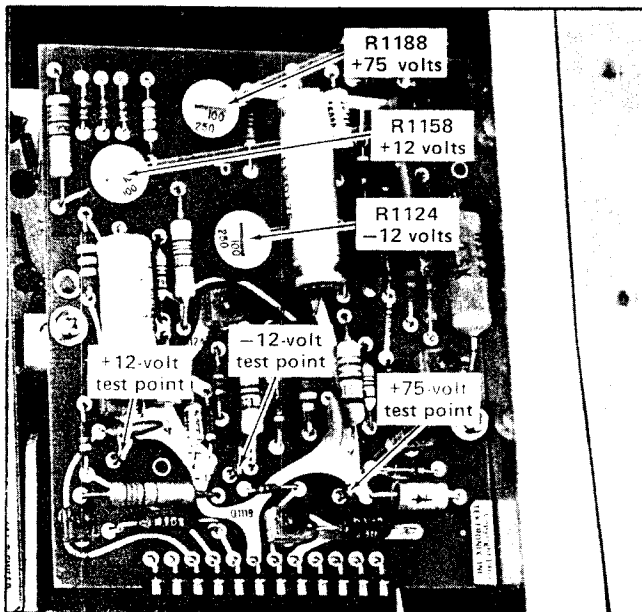

Fig. 5-3. Low-voltage power supply test points and adjustments (Low-Voltage Regulator circuit board).

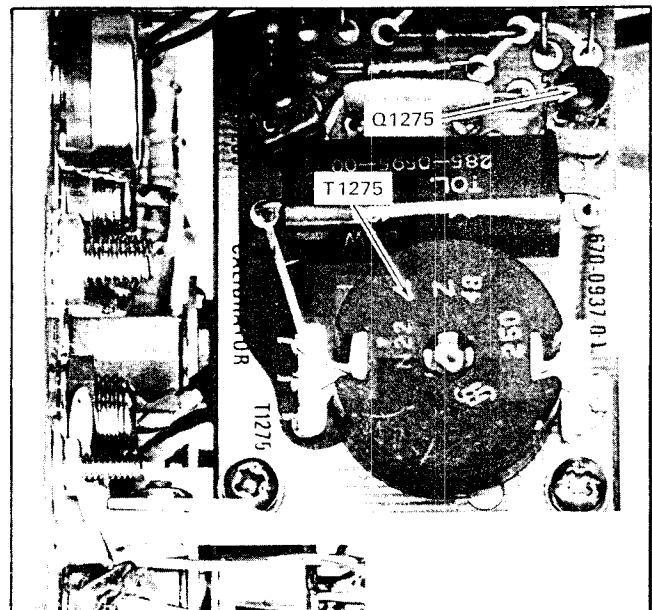

Fig. 5-4. Location of Q1275 and Calibrator frequency adjustment T1275 (Calibrator circuit board).

## Adjustment—454A/R454A

e. Re-install Q1275 in its socket on the Calibrator circuit board.

f. Connect the precision DC voltmeter between the +12-volt test point on the Low-Voltage Regulator circuit board and chassis ground. See Fig. 5-3.

g. CHECK—Meter reading of +12.0 to +12.2 volts.

h. INTERACTION—May affect operation of all circuits within the 454A.

### 3. Adjust +75-Volt Power Supply

a. Connect the precision DC voltmeter between the +75-volt test point on the Low Voltage Regulator circuit board (see Fig. 5-3) and chassis ground.

b. CHECK—Meter reading of +75 volts ( $\pm 0.75$  volt).

c. ADJUST— +75 Volts adjustment R1188 (see Fig. 5-3) for a meter reading of +75 volts ( $\pm 0.278$  volt).

d. INTERACTION—May affect operation of all circuits within the 454A.

### 4. Adjust High-Voltage Supply and Check Regulation

a. Connect the precision DC voltmeter (use the precision 2 kV divider) between the -1960 V test point (see Fig. 5-5) and chassis ground.

b. CHECK—Meter reading of -1960 volts ( $\pm 58.8$  volts).

c. ADJUST—High-Voltage adjustment R1401 (see Fig. 5-5) for a meter reading of -1960 volts ( $\pm 19.6$  volts).

d. INTERACTION—May affect operation of all circuits within the 454A.

e. CHECK—Change the autotransformer output voltage throughout the regulating range selected by the Line Voltage Selector assembly on the rear panel and check for less than  $\pm 58.8$  volts change in the high-voltage output level. Also vary the INTENSITY control throughout its range at the maximum and minimum line voltage; check that regulation remains within given limits.

#### NOTE

*If the high-voltage supply is out of regulation, check the regulation of the low-voltage supplies (step 5) before troubleshooting in the high-voltage supply.*

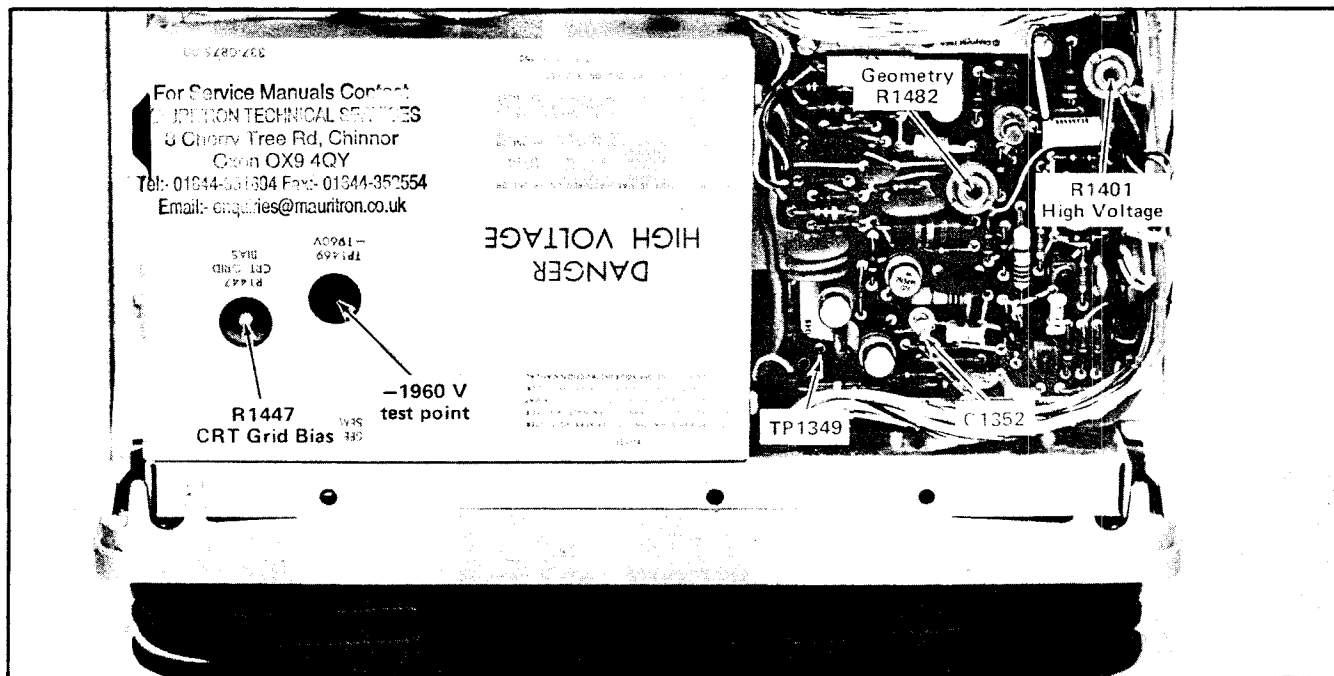

Fig. 5-5. Location of high-voltage and Z-AXIS adjustments and test-points.

f. Return the autotransformer output voltage to the center of the regulating range selected by the Line Voltage Selector assembly.

## 5. Check Low-Voltage Power Supply Ripple

### NOTE

*This step also checks regulation of the low-voltage supplies.*

- a. Connect a 1X probe to the test oscilloscope input.
- b. Set the test oscilloscope for a vertical deflection of 0.005 volts/division, AC coupled, at a sweep rate of five milliseconds/division. Use line-frequency triggering to provide a stable display.
- c. CHECK—Two millivolts (0.4 division) peak-to-peak maximum line-frequency ripple on the -12-volt, +12-volt, and +75-volt supplies while changing the autotransformer output voltage throughout the regulating range selected by the Line Voltage Selector assembly on the rear panel. Power-supply test points are shown in Fig. 5-3.
- d. Return autotransformer output voltage to the center of the regulating range selected by the Line Voltage Selector assembly. (If the line voltage is near the center of the regulating range, the 454A can be connected directly to the line; otherwise, leave the instrument connected to the autotransformer for the remainder of this procedure.)

e. Disconnect all test equipment.

## 6. Adjust Calibrator Repetition Rate

a. Set the CH 1 and CH 2 VOLTS/DIV switches to .5, the MODE switch to ALT, and the A SWEEP MODE switch to AUTO TRIG.

b. Connect 1 millisecond time markers from the time-mark generator to the CH 2 input connector via a 42-inch BNC cable.

c. Connect the 1 V CAL 1 kHz connector to the CH 1 input connector via an 18-inch BNC cable.

d. Position the displays so the tips of the markers fall just below the rising portions of the square wave.

e. CHECK—CRT display for one cycle of calibrator waveform for each time mark.

f. ADJUST—Calibrator Frequency adjustment T1275 (see Fig. 5-4) for one cycle of calibrator waveform for each time mark.

g. Set INT TRIG switch to CH 1 ONLY OR X-Y and the A TIME/DIV switch to .2 ms.

h. CHECK—CRT display for slow, or no, drift of the time markers.

i. ADJUST—Calibrator Frequency adjustment T1275 (see Fig. 5-4) for minimum drift of time markers.

j. Disconnect all test equipment.

## NOTES

---

---

---

---

---

---

---

---

---

---

## DISPLAY AND Z-AXIS ADJUSTMENT

### Equipment Required

- |                           |                           |
|---------------------------|---------------------------|
| 1. Precision DC Voltmeter | 3. Three-Inch Screwdriver |
| 2. Time Mark Generator    | 4. Test Oscilloscope      |
|                           | 5. 10X Probe              |

### Control Settings

Preset instrument controls to the settings given under Preliminary Control Settings.

### 7. Adjust CRT Grid Bias

a. Connect the precision DC voltmeter between TP1349 (Z Axis Amplifier board; see Fig. 5-5) and chassis ground.

b. Set the A SWEEP MODE switch to SINGLE SWEEP.

c. Set the INTENSITY control for a meter reading of +12 volts.

d. ADJUST—CRT Grid Bias adjustment, R1447 (see Fig. 5-5), so the spot on the CRT just disappears (it may be necessary to turn the horizontal POSITION control clockwise to bring the spot onto the viewing area).



*Do not allow the bright spot to remain stationary for an extended period as it may burn the CRT phosphor.*

e. Disconnect the precision DC voltmeter.

### 8. Adjust Trace Alignment

a. Set the A SWEEP MODE switch to AUTO TRIG.

b. Advance the INTENSITY control until the trace is visible.

c. Turn the CH 1 POSITION control to move the trace to the center horizontal line.

d. Set the FOCUS control for as sharp a display as possible.

e. CHECK—The trace should be parallel with the center horizontal line.

f. ADJUST—TRACE ROTATION adjustment, R1480 (on instrument side panel) so the trace is parallel to the horizontal graticule lines.

g. INTERACTION—Check step 10.

### 9. Adjust Asigmatism

a. Connect the time-mark generator to the INPUT CH 1 connector with the 42-inch BNC cable.

b. Set the time-mark generator for 1- and 0.1-millisecond markers.

c. Set the CH 1 VOLTS/DIV switch so the large markers extend beyond the bottom and the top of the graticule area.

d. Set the A LEVEL control for a stable display.

e. CHECK—Markers should be well defined with optimum setting of FOCUS control.

f. ADJUST—FOCUS control and ASTIG adjustment, R1489 (on instrument side panel) for best definition of the markers.

### 10. Adjust Y Axis Alignment

a. CHECK—The markers should be parallel to the center vertical line.

b. ADJUST—Y Axis Align adjustment, R1485 (see Fig. 5-6) to align the markers with the center vertical line.

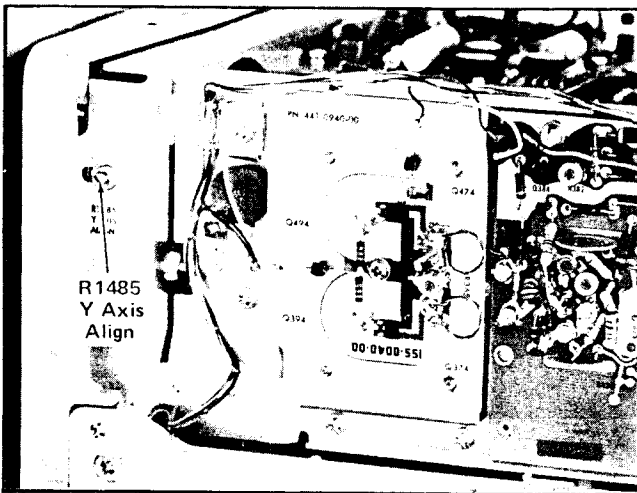

Fig. 5-6. Location of Y AXIS Alignment adjustment (left side).

## 11. Adjust CRT Geometry

- a. Set the horizontal POSITION and the A VARIABLE controls so a large marker coincides with each vertical graticule line.
- b. CHECK—Geometry at left and right edges of the graticule.
- c. ADJUST—Geometry adjustment, R1482 (see Fig. 5-5 for minimum bowing of the trace at the left and right edges of the graticule.
- d. INTERACTION—Recheck step 10.
- e. Disconnect the time-mark generator.

- f. Position the trace to the top of the graticule area.
- g. CHECK—Deviation from straight line should not exceed 0.1 division.
- h. Position the trace to the bottom of the graticule area.
- i. CHECK—Deviation from straight line should not exceed 0.1 division.
- j. Disconnect all test equipment.

## 12. Adjust Z Axis Compensation

- a. Connect the 10X probe to the input connector of the test oscilloscope.
- b. Connect the 10X probe tip to TP1349 (see Fig. 5-5).
- c. Set the test oscilloscope for a vertical deflection factor of 0.5 volt/division (5 volts/division with probe) at a sweep rate of 0.1 microsecond/division.
- d. Set the INTENSITY control so the test oscilloscope display is three divisions in amplitude.
- e. CHECK—Test oscilloscope display for optimum square corner (slightly rounded) on unblanking gate.
- f. ADJUST—C1352 (see Fig. 5-5) for optimum square corner on the unblanking gate.
- g. Disconnect all test equipment.

## NOTES

---



---



---



---



---



---



---



---

## VERTICAL SYSTEM ADJUSTMENT

## Equipment Required

- |  |  |
|--|--|
| 1. Precision DC Voltmeter                              | 11. 10X Probe  |
| 2. Standard Amplitude Calibrator (067-0502-01)         | 12. GR 5 Nanosecond Cable                              |
| 3. Square-Wave Generator (Type 106)                    | 13. 42-Inch 50 $\Omega$ BNC Cable                      |
| 4. Fast-Rise High-Amplitude Pulse Generator (Type 109) | 14. Dual-Input Coupler                                 |
| 5. Test Oscilloscope                                   | 15. GR 50 $\Omega$ In-Line Termination                 |
| 6. Charge Line (Type 113)                              | 16. GR 90° Elbow                                       |
| 7. Signal Insertion Unit (067-0553-01)                 | 17. GR Short-Circuit Termination                       |
| 8. 15 pF Input RC Normalizer (067-0537-00)             | 18. Three-Inch Screwdriver                             |
| 9. 50 $\Omega$ Signal Pickoff (Type CT-3)              | 19. Low-Capacitance Screwdriver                        |
| 10. 2 Nanosecond Filter (067-0635-00)                  | 20. Tuning Tool With Insert for 5/64-Inch ID Hex Cores |

## Control Settings

Preset the instrument controls to the settings given under Preliminary Control Settings.

## 13. Adjust Channel 1 and 2 Step Attenuator Balance

- a. Set the Input Coupling switches to GND.
- b. Position the trace to the center horizontal line with the CH 1 POSITION control.
- c. CHECK—Change the CH 1 VOLTS/DIV switch from 10 mV to 2 mV. Trace should not move more than 0.1 division vertically.
- d. ADJUST—CH 1 STEP ATTEN BAL adjustment, R21 (on instrument front panel) for 0.1 division or less trace shift as the CH 1 VOLTS/DIV switch is changed from 10 mV to 2 mV.

## NOTE

Use the BANDWIDTH-BEAM FINDER switch to locate the trace if it is deflected off screen when switching to 5 mV or 2 mV.

- e. Set the MODE switch to CH 2.

- f. Position the trace to the center horizontal line with the CH 2 POSITION control.

- g. CHECK—Change the CH 2 VOLTS/DIV switch from 10 mV to 2 mV. Trace should not move more than 0.1 division vertically.

- h. ADJUST—CH 2 STEP ATTEN BAL adjustment, R121 (on instrument front panel) for 0.1 division or less trace shift as the CH 2 VOLTS/DIV switch is changed from 10 mV to 2 mV.

- i. CHECK—Change the CH 2 VOLTS/DIV switch from 10 mV to 50 mV. Trace should not move more than 0.1 division vertically.

- j. ADJUST—CH 2 Internal Atten Bal adjustment, R128 (see Fig. 5-7), for 0.1 division or less shift as the CH 2 VOLTS/DIV switch is changed from 10 mV to 50 mV.

- k. Set the MODE switch to CH 1.

- l. CHECK—Change the CH 1 VOLTS/DIV switch from 10 mV to 50 mV. Trace should not move more than 0.1 division vertically.

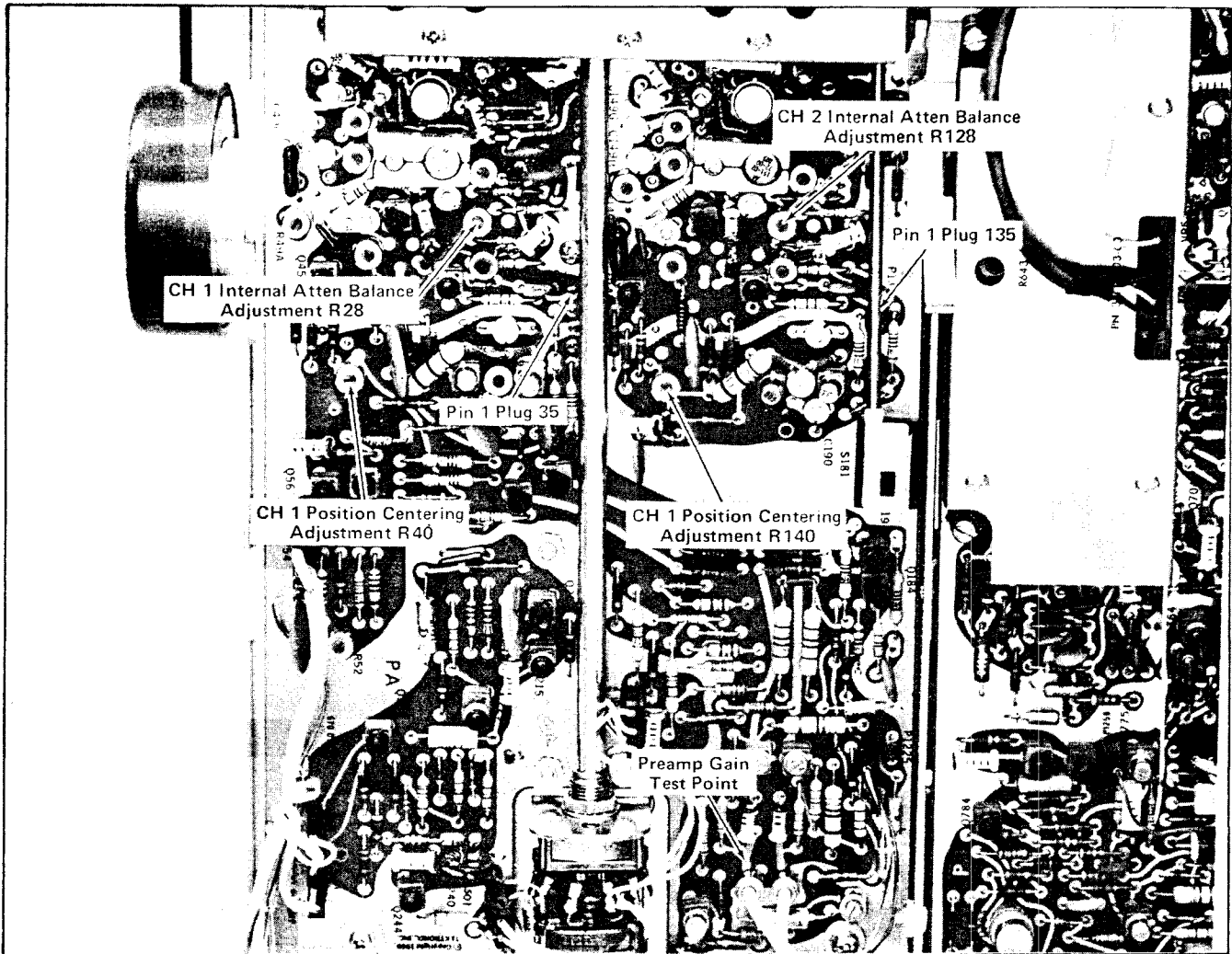

Fig. 5-7. Location of CH 1 and CH 2 Internal Atten Balance adjustments and Position Centering adjustments and test points.

m. ADJUST—CH 1 Internal Atten Bal adjustment, R28 (see Fig. 5-7), for 0.1 division or less trace shift as the CH 1 VOLTS/DIV switch is changed from 10 mV to 50 mV.

n. Repeat parts a through m for optimum step attenuator balance.

#### 14. Adjust Vertical Centering

a. Set the MODE switch to CHOP.

b. Move the traces to the center horizontal line with the CH 1 and CH 2 POSITION controls.

c. Set the MODE switch to ADD.

d. CHECK—Trace should be at the center horizontal line of the graticule. Note the amount that the trace is deflected away from the center horizontal line.

e. ADJUST—Vertical Centering adjustment, R334 (see Fig. 5-8), to move the trace twice the distance observed in part d away from the center horizontal line.

f. Repeat parts a through e until the trace remains at the center horizontal line when the MODE switch is changed from CHOP to ADD.

g. INTERACTION—Check Step 15.

Ⓐ

For Service Manuals Contact  
MAURITRON TECHNICAL SERVICES  
8 Cherry Tree Rd, Chinnor  
Oxon OX9 4QY  
Tel:- 01844-351094 Fax:- 01344-352554  
Email:- enquires@mauriron.co.uk

5-37

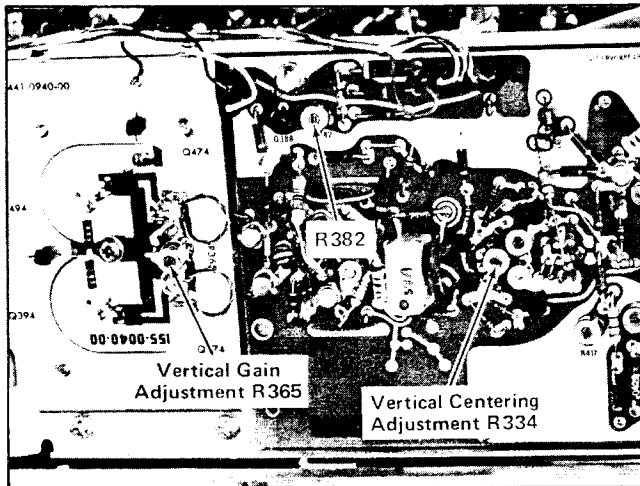

Fig. 5-8. Location of Vertical Output Amplifier Centering and Gain adjustments and R382.

### 15. Adjust Channel 1 and 2 Position Centering

a. Connect the precision DC voltmeter between pin 1 of Plug P35 on the Vertical Preamp circuit board (see Fig. 5-7) and ground.

b. Set the CH 1 POSITION control for a meter reading of  $-5.7$  volts. (The dot on the CH 1 POSITION control should be centered mechanically. If not, loosen the set screw and reposition the knob.)

c. Set the MODE switch to CH 1.

d. CHECK—Trace at the center horizontal line.

e. ADJUST—CH 1 Position Center adjustment, R40 (see Fig. 5-7), to position the trace to the center horizontal line.

f. Set the MODE switch to CH 2.

g. Connect the precision DC voltmeter between pin 1 of plug P135 on the Vertical Preamp circuit board and ground (see Fig. 5-7).

h. Set the CH 2 POSITION control for a meter reading of  $-5.7$  volts. (The dot on the CH 2 POSITION control should be centered mechanically. If not, loosen the set screw and reposition the knob.)

i. CHECK—Trace at the center horizontal line.

j. ADJUST—CH 2 Position Center adjustment, R140 (see Fig. 5-7), to position the trace to the center horizontal line.

k. Disconnect all test equipment.

### 16. Adjust Vertical Output Amplifier Thermal Compensation

a. Set the Vertical MODE switch to ALT.

b. Position the A trace 3 divisions above and the B trace 3 divisions below graticule center.

c. Set the TIME/DIV switch to 2 ms.

d. CHECK—Both traces are flat in the area of about the first two divisions.

e. ADJUST—R382 (see Fig. 5-8) for best flatness of both traces. This is a preliminary adjustment, and may have to be re-adjusted during High Frequency Compensation.

### 17. Adjust Channel 1 and 2 Vertical Preamp and Vertical Output Amp Gain

a. Set both VOLTS/DIV switches to 20 mV/DIV.

b. Set the Vertical MODE switch to CH 1.

c. Connect the standard amplitude calibrator (067-0502-01) output connector to the CH 1 and CH 2 Input connectors through a 42-inch BNC cable and the dual-input coupler.

d. Set the standard amplitude calibrator for a 0.1-volt output.

e. Connect the 10X probe to the input of the test oscilloscope.

f. Set the test oscilloscope for a vertical deflection factor of 50 millivolts/division, AC coupled, at a sweep rate of 0.5 millisecond/division.

g. Connect the 10X probe tip to the gain test point (see Fig. 5-7).



h. CHECK—Test oscilloscope display for 3 divisions of deflection.

i. ADJUST—Channel 1 GAIN adjustment R67 (located on instrument front panel) for exactly 3 divisions of deflection in the test oscilloscope display.

j. CHECK—CRT display of the scope under calibration for 5 divisions of deflection.

k. ADJUST—Vertical Gain adjustment R365 (see Fig. 5-8) for exactly 5 divisions of deflection.

l. Set the Vertical MODE switch to ADD.

m. Set the Channel 2 INVERT switch to its out position.

n. CHECK—CRT display for a straight line.

o. ADJUST—Channel 2 GAIN ADJUSTMENT R167 (located on instrument front panel) for a straight line.

p. Disconnect all test equipment.

q. Return the INVERT switch to the in position.

## 18. Adjust Channel 1 VOLTS/DIV Switch Compensation

a. Connect the square-wave generator (Type 106) high-amplitude output connector to the CH 1 input connector through the five-nanosecond GR cable, GR 50-ohm in-line termination, and the 15 pF input RC normalizer, in given order.

b. Set the Vertical MODE switch to CH 1 and the CH 1 VOLTS/DIV switch to 10 mV/DIV.

c. Set the square-wave generator for six divisions of one kilohertz signal.

d. CHECK—CRT display at each CH 1 VOLTS/DIV switch setting listed in Table 5-5 for optimum square corner and flat top with less than 0.06 division rolloff or overshoot.

e. ADJUST—CH 1 VOLTS/DIV switch compensation as given in Table 5-5. First adjust for optimum square corner on the display and then for optimum flat top. Remove the 15 pF input RC normalizer when adjusting for optimum square corner and replace it when adjusting for optimum flat top. Readjust the generator output with each setting of the CH 1 VOLTS/DIV switch to provide six divisions of deflection. Fig. 5-9 shows the location of the variable capacitors.

TABLE 5-5

CH 1 VOLTS/DIV Switch Compensation

CH 1 VOLTS/DIV Switch Setting	Adjust for Optimum	
	Square Corner <sup>1</sup>	Flat Top
10 mV		C9
.1 V	C5B	C5A
1 V	C6B	C6A

<sup>1</sup> Remove the 15 pF input RC normalizer when adjusting for optimum square corner.

## 19. Adjust Channel 2 Volts/Division Switch Compensation

a. Set the MODE switch to CH 2.

b. Connect the square-wave generator high-amplitude output connector to the INPUT CH 2 connector through the five nanosecond GR cable, GR 50-ohm in-line termination and 15 pF input RC normalizer, in given order.

c. Set the square-wave generator for six divisions of one-kilohertz signal.

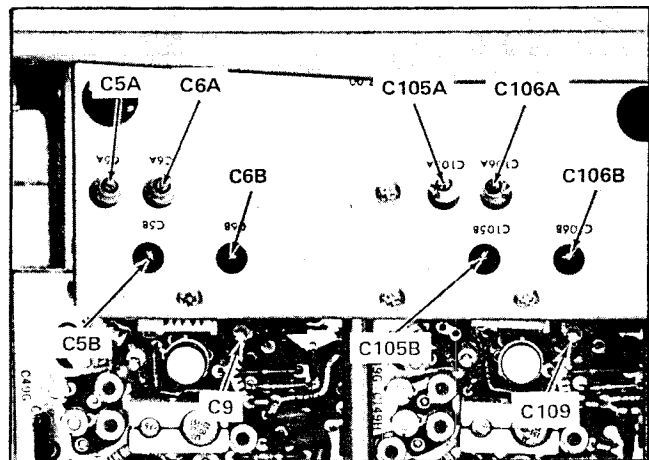

Fig. 5-9. Location of compensation adjustments.

## Adjustment—454A/R454A

d. CHECK—CRT display at each CH 2 VOLTS/DIV switch setting listed in Table 5-6 for optimum square corner and flat top with less than 0.06 division rolloff or overshoot.

e. ADJUST—CH 2 VOLTS/DIV switch compensation as given in Table 5-6. First adjust for optimum square corner on the display and then for optimum flat top. Remove the 15 pF input RC normalizer when adjusting for optimum square corner, and replace it when adjusting for optimum flat top. Readjust the generator output with each setting of the CH 2 VOLTS/DIV switch to provide six divisions of deflection. Fig. 5-9 shows the location of the variable capacitors.

f. Disconnect all test equipment.

TABLE 5-6  
CH 2 VOLTS/DIV Switch Compensation

CH 2 VOLTS/DIV Switch Setting	Adjust for Optimum	
	Square Corner <sup>1</sup>	Flat Top
10 mV		C109
.1 V	C105B	C105A
1 V	C106B	C106A

<sup>1</sup>Remove the 15 pF input RC normalizer when adjusting for optimum square corner.

## 20. Adjust Vertical Output Amplifier High Frequency Compensation

a. Disconnect the input leads to the delay line from the Vertical Preamp circuit board (see Fig. 5-10A).

b. Connect the signal insertion unit to the input leads of the delay line. Connect the alligator clip from the signal insertion unit to -12 volts at Pin 1 of P1225 on the Vertical Preamp circuit board (see Fig. 5-10A).

c. Note the exact position of the trace so R334 can be returned to the correct adjustment in part l of this step.

d. Connect the fast-rise, high-amplitude pulse generator (Type 109) 50 Ω output connector to the signal insertion unit through a 5 ns GR cable, a CT-3 Signal Pickoff unit, and a 2 ns filter in that order.

e. Connect the Type 113 charge line to the Chg Line 2 connector of the fast-rise, high-amplitude pulse generator with a 50 Ω GR 90° elbow. Support the pulse generator as necessary to make this connection. Connect a GR-to-BNC male adapter to the Chg Line 1 connector and a BNC-female-to-BNC-female adapter to the GR adapter.

f. Set the fast-rise pulse generator for a four division display. The Type 113 will supply a pulse approximately 120 nanoseconds long and the adapters on the other charge line connector will supply a narrower pulse approximately 1 nanosecond long.



Fig. 5-10. (A) Location of connection points for signal insertion unit. (B) Location of Vertical Output Amplifier Compensation adjustments.

g. Center the display vertically with Vertical Centering adjustment R334.

h. CHECK—CRT display for optimum risetime and flat top.

i. ADJUST—If greater than 4% aberrations are observed (disregard the first six nanoseconds after leading edge), use the following adjustment procedure (see Fig. 5-10B for location of adjustments). If less than 4%, proceed to part j.

### NOTE

Change the MAG switch from X10 to OFF and compare the response at both sweep rates. Then adjust for the best overall response. The 4% specification on aberrations is applicable only at the temperature of +25°C, ±5°C.

1. Preset R394 and R494 to midrange.
2. Adjust L394 and L494 for smoothest pulse top after the first six nanoseconds.
3. Adjust R394 and R494 to remove fast wrinkles after the first six nanoseconds.
4. Repeat 2 and 3 for best overall response after the first six nanoseconds.
5. Proceed to step j.

j. ADJUST—See Fig. 5-10B for adjustment locations. Sufficient main amplifier bandwidth is indicated if the narrow pulse amplitude is 50% or more of the longer pulse amplitude.

1. Set C426 to minimum capacitance and R426 to midrange.
2. Adjust C353 and R353 for optimum risetime and flat top.
3. Adjust R426 for optimum square corner.
4. Adjust C426 for optimum square corner.
5. Adjust L394 and L494 for smoothest pulse top after the first six nanoseconds.
6. Adjust R394 and R494 to remove fast wrinkles after the first six nanoseconds.
7. Repeat 1 through 6 for optimum pulse response.

k. Reconnect the delay line input leads to the Vertical Preamp circuit board. The cable with the red stripe goes to the connector nearest the middle of the instrument.

l. ADJUST—Vertical Centering adjustment, R334 (see Fig. 5-10B) to return the trace to the same position noted in part c of this step. (If the correct adjustment for R334 is not known, adjust Vertical Centering as given in step 13.)

m. Disconnect all test equipment.

n. INTERACTION—Check steps 21 and 22.

## 21. Adjust Channel 1 Preamp High-Frequency Compensation

a. Connect the Type 113 charge line to the Chg Line 2 connector of the fast-rise, high-amplitude pulse generator with a 50  $\Omega$  GR 90° elbow. Support the pulse generator as necessary to make this connection. Connect a GR-to-BNC male adapter to the Chg Line 1 connector and a BNC-female-to-BNC-female adapter to the GR adapter.

b. Connect the fast-rise, high-amplitude pulse generator 50  $\Omega$  output connector to the CH 1 input connector through a 5 nanosecond GR cable, a GR 10X attenuator and a GR 50  $\Omega$  in-line termination.

c. Set the CH 1 and CH 2 VOLTS/DIV switches to 10 mV and the A and B TRIGGERING SOURCE switches to INT.

d. Set the fast-rise pulse generator for a four division display.

e. Center the display vertically with the POSITION control.

f. CHECK—CRT display for optimum risetime and flat top. Use the narrow pulse response amplitude as an indicator of vertical amplifier bandwidth. The narrow pulse amplitude should be 40% or more of the longer pulse amplitude in order to meet risetime specifications in all positions of the VOLTS/DIV switch except 2 mV and 5 mV.

Minimum risetimes should be:

10 mV, 20 mV and 50 mV	2.4 nanoseconds
5 mV	3.5 nanoseconds
2 mV	7 nanoseconds

Aberrations should not exceed 4% peak to peak total.

### NOTE

The 4% specification on aberrations is applicable only at the temperature of +25° C,  $\pm 5^\circ$  C.

g. ADJUST—If the CRT display exceeds the limits of the CHECK—step, use the following adjustment procedure. See Fig. 5-11 for location of adjustments.

1. Remove the signal from the CH 1 input connector.
2. Remove the GR 50  $\Omega$  in-line termination and replace it with a GR to BNC adapter. Attach the following special BNC cable to the GR to BNC adapter.

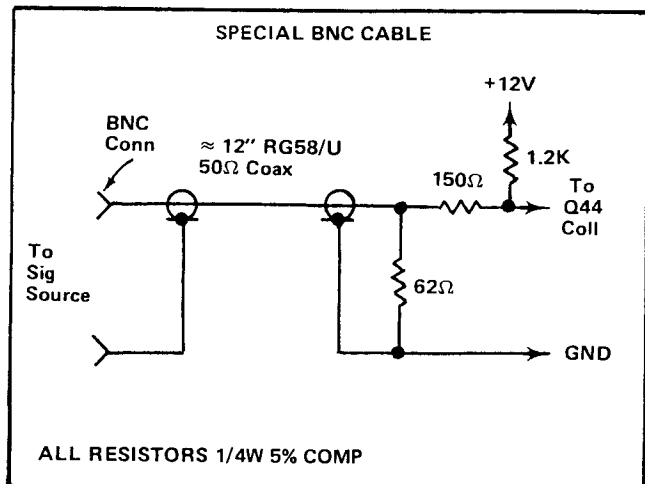

3. Remove Q44 from its socket.

4. Apply the signal from the fast-rise pulse generator to the collector lead of Q44 by inserting the loose lead of the 150  $\Omega$  resistor into the collector hole of the Q44 socket.

5. Adjust the fast-rise pulse generator output signal amplitude to obtain a 4-division display.

6. Use R334 (Vertical Centering adjustment in the Vertical Output Amplifier) as a positioning control to center the display vertically.

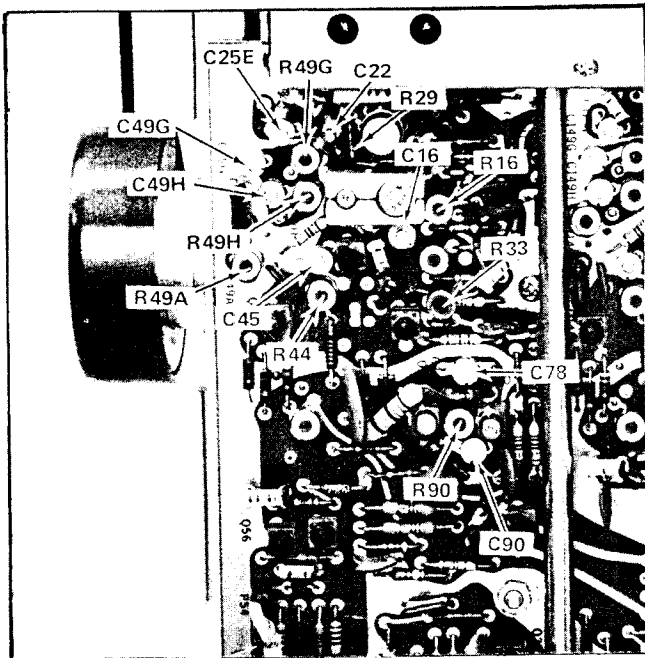

Fig. 5-11. Location of CH 1 compensation adjustments.

7. Check the CRT display for optimum risetime and flat top. Aberrations should be 3% or less. Use the narrow pulse amplitude as an indicator of amplifier bandwidth. The narrow pulse amplitude should be 52% or more of the longer pulse amplitude.

8. If the CRT display exceeds the limits of the check step, adjust C78, R75, C90 and R90 as necessary to obtain the best risetime and flat top.

9. Disconnect the special BNC cable from the instrument.

10. Reinstall Q44 in its socket.

11. Remove the special BNC cable from the signal source and replace it with a GR 50 Ω in-line termination.

12. Readjust Vertical Centering adjustment R334 as given in Adjustment Procedure Step 14.

13. Apply the signal from the fast-rise pulse generator to the CH 1 input connector and adjust for a 4-division display at 10 mV/div.

14. Adjust R16 and C16 for minimum aberrations.

15. Adjust R49H and C49H for best pulse-top flatness.

16. Adjust R44 and C45 for best pulse front corner.

17. R417 may be readjusted if necessary for best pulse-top flatness. Recheck vertical gain if R417 is adjusted.

18. Set the CH 1 VOLTS/DIV switch to 20 mV and readjust the fast-rise pulse generator for a 4-division display.

19. ADJUST-C25E for best front corner.

20. Set the CH 1 VOLTS/DIV switch to 50 mV and readjust the fast-rise pulse generator for a 4-division display.

21. ADJUST-C16, C22 and R33 for best front corner and pulse-top flatness.

*NOTE*

*R16, C16, R33 and C22 have the most effect in the 50 mV position of the VOLTS/DIV switch.*

22. If necessary, the value of R29 can be selected to achieve minimum aberrations.

23. Set the CH 1 VOLTS/DIV switch to 5 mV and readjust the fast-rise pulse generator for a 4-division display. Add attenuation as necessary to obtain the desired display amplitude.

24. ADJUST-R49G and C49G for best front corner.

25. Set the CH 1 VOLTS/DIV switch to 2 mV and readjust the fast-rise pulse generator for a 4-division display.

26. ADJUST-R49A for best corner.

27. Repeat steps 14 through 26 until proper compensation is obtained in all positions of the VOLTS/DIV switch.

**22. Adjust Channel 2 Preamp High-Frequency Compensation**

a. Remove the GR 50 Ω in-line termination from the CH 1 input connector and re-install it on the CH 2 input connector.

b. Set the vertical MODE switch to CH 2.

c. Set the fast-rise pulse generator for a four division display.

d. Center the display vertically with the POSITION control.

e. CHECK-CRT display for optimum risetime and flat top. Use the narrow pulse response amplitude as an indicator of vertical amplifier bandwidth. The narrow pulse amplitude should be 40% or more of the longer pulse amplitude in order to meet risetime specifications in all positions of the VOLTS/DIV switch except 2 mV and 5 mV.

Minimum risetimes should be:

10 mV, 20 mV and 50 mV	2.4 nanoseconds
5 mV	3.5 nanoseconds
2 mV	7 nanoseconds

Aberrations should not exceed 4% peak to peak total.

## NOTE

The 4% specification on aberrations is applicable at the temperature of  $+25^{\circ}\text{C}$ ,  $\pm 5^{\circ}\text{C}$ .

f. ADJUST—If the CRT display exceeds the limits of the CHECK—step, use the following adjustment procedure. See Fig. 5-12 for location of adjustments.

1. Remove the signal from the CH 2 input connector.
2. Remove the GR  $50\ \Omega$  in-line termination and replace it with a GR to BNC adapter. Attach the special BNC cable shown in part 2 of step 21g to the GR to BNC adapter.
3. Remove Q144 from its socket.
4. Apply the signal from the fast-rise pulse generator to the collector lead of Q144 by inserting the loose lead of the  $150\ \Omega$  resistor into the collector hole of the Q144 socket.
5. Adjust the fast-rise pulse generator output signal amplitude to obtain a 4-division display.
6. Use R334 (Vertical Centering adjustment in the Vertical Output Amplifier) as a positioning control to center the display vertically.
7. Check the CRT display for optimum risetime and flat top. Aberrations should be 3% or less. Use the narrow pulse amplitude as an indicator of amplifier bandwidth. The narrow pulse amplitude should be 52% or more of the longer pulse amplitude.

8. If the CRT display exceeds the limits of the check step, adjust C178, R175, C190 and R190 as necessary to obtain the best risetime and flat top.
9. Disconnect the special BNC cable from the instrument.
10. Reinstall Q144 in its socket.
11. Remove the special BNC cable from the signal source and replace it with a GR  $50\ \Omega$  in-line termination.
12. Readjust Vertical Centering adjustment R334 as given in Adjustment Procedure Step 14.
13. Apply the signal from the fast-rise pulse generator to the CH 2 input connector and adjust for 4-division display at 10 mV/div.
14. Adjust R116 and C116 for minimum aberrations.
15. Adjust R149H and C149H for best pulse-top flatness.
16. Adjust R144 and C145 for best pulse front corner.
17. Set the CH 2 VOLTS/DIV switch to 20 mV and readjust the fast-rise pulse generator for a 4-division display.
18. ADJUST—C125E for best front corner.
19. Set the CH 2 VOLTS/DIV switch to 50 mV and readjust the fast-rise pulse generator for a 4-division display.
20. ADJUST—C116, C122 and R133 for best front corner and pulse-top flatness.

## NOTE

R116, C116, R133 and C122 have the most effect in the 50 mV position of the VOLTS/DIV switch.

21. If necessary, the value of R129 can be selected to achieve minimum aberrations.
22. Set the CH 2 VOLTS/DIV switch to 5 mV and readjust the fast-rise pulse generator for a 4-division display. Add attenuation as necessary to obtain the desired display amplitude.
23. ADJUST—R149G and C149G for best front corner.
24. Set the CH 2 VOLTS/DIV switch to 2 mV and readjust the fast-rise pulse generator for a 4-division display.
25. ADJUST—R149A for best corner.
26. Repeat steps 14 through 25 until proper compensation is obtained in all positions of the VOLTS/DIV switch.

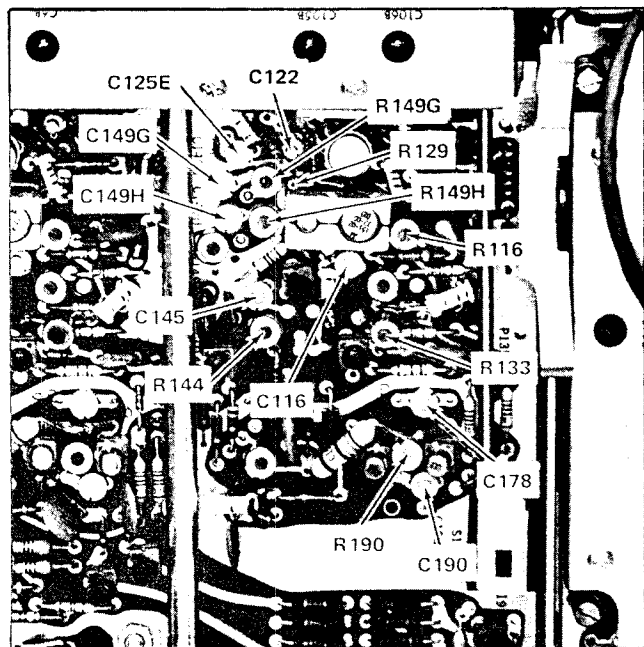

Fig. 5-12. Location of CH 2 compensation adjustments.

## TRIGGERING ADJUSTMENT

### Equipment Required

- |  |  |
|--|--|
| <ol style="list-style-type: none"> <li>1. Type 191 Constant Amplitude Signal Generator.</li> <li>2. GR to BNC female adapter.</li> <li>3. 42-inch 50 <math>\Omega</math> BNC cable.</li> </ol> | <ol style="list-style-type: none"> <li>4. 18-inch 50 <math>\Omega</math> BNC cable.</li> <li>5. 50 <math>\Omega</math> BNC termination.</li> <li>6. Three-inch screwdriver.</li> </ol> |
|--|--|

### Control Settings

Preset instrument controls to the settings given under Preliminary Control Settings.

### 23. Adjust CH 1 OUT DC Level

- a. Connect the CH 1 OUT connector to the CH 2 input connector with an 18-inch BNC cable.
- b. With the Vertical MODE switch set to CH 1, position the CH 1 trace to the center horizontal graticule line with the CH 1 POSITION control.
- c. Set the Vertical MODE switch to CH 2 and the CH 2 Input Coupling switch to GND.
- d. Position the CH 2 trace to the center horizontal graticule line with the CH 2 POSITION control.
- e. Set the CH 2 Input Coupling switch to DC.
- f. CHECK—CRT display for trace within 1.5 divisions of the center horizontal graticule line.
- g. ADJUST—CH 1 Output DC Level adjustment R52 (see Fig. 5-13) to position the trace to the center horizontal graticule line.
- h. Disconnect the 18-inch BNC cable from between the CH 2 Input connector and the CH 1 OUT connector.

### 24. Adjust A and B Trigger Level Centering

- a. Connect the medium-frequency constant-amplitude signal generator (Type 191) to the CH 1 Input connector

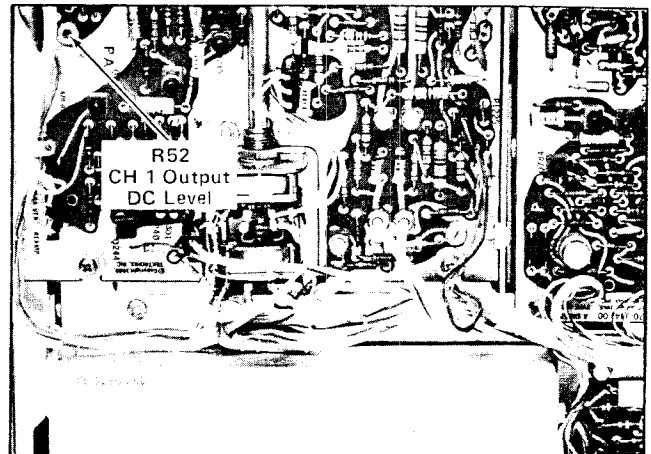

Fig. 5-13. Location of CH 1 output DC level adjustment (Vertical Preamp circuit board).

through a GR to BNC female adapter, a 42-inch 50  $\Omega$  BNC cable and a BNC 50  $\Omega$  termination.

- b. Set the Vertical MODE switch to CH 1.
- c. With the CH 1 VOLTS/DIV switch set to 50 mV, adjust the output of the medium-frequency constant-amplitude generator for a 0.3-division display at 50 kilohertz.
- d. Be sure the A LEVEL control is set to 0.
- e. CHECK—Stable CRT display.
- f. ADJUST—A Trigger Level Centering adjustment R643 (see Fig. 5-14) for a stable display.
- g. Change the HORIZ DISPLAY switch to B (DELAYED SWEEP).

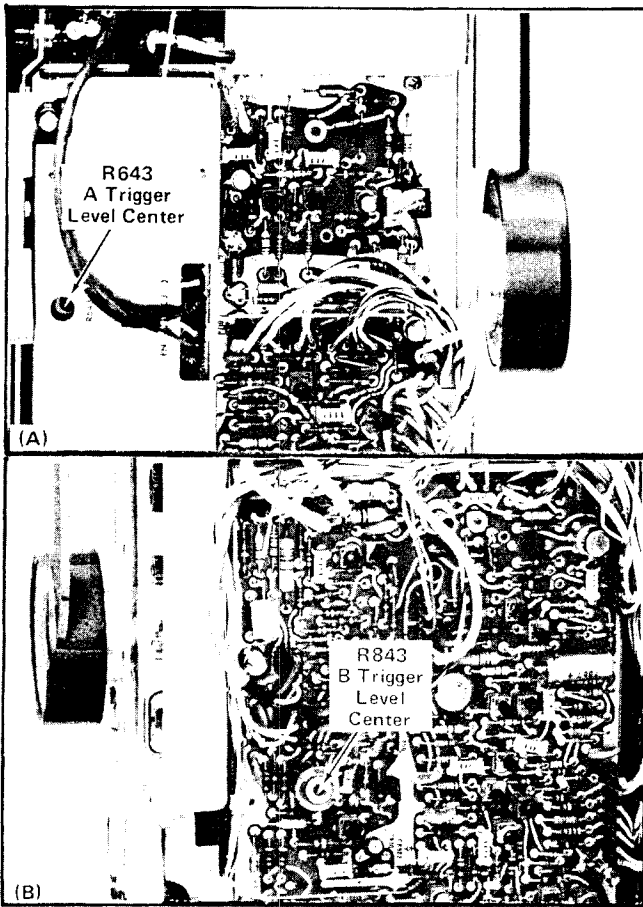

Fig. 5-14. (A) Location of A Trigger Level Center adjustment (A Sweep circuit board). (B) Location of B Trigger Level Center Adjustment (B Sweep circuit board).

- h. Be sure the B LEVEL control is set to 0.
- i. CHECK—Stable CRT display.
- j. ADJUST—B Trigger Level Centering adjustment R843 (see Fig. 5-14) for a stable display.

## 25. Adjust Trigger Preamp DC Level and Normal Trigger DC Level

- a. Set the Vertical MODE switch to CH 1, the TRIGGER switch to CH 1 ONLY, and the A TRIGGERING COUPLING switch to DC.
- b. Move the trace to the center horizontal line with the CH 1 POSITION control.

- c. CHECK—Stable CRT display. CH 1 light in both A and B Triggering must be on.
- d. ADJUST—Trigger Preamp DC Level adjustment, R511 (see Fig. 5-15) for a stable display.
- e. Set the TRIGGER switch to NORM.
- f. CHECK—Stable CRT display.
- g. ADJUST—Normal Trigger DC Level adjustment, R272 (see Fig. 5-15) for a stable display.

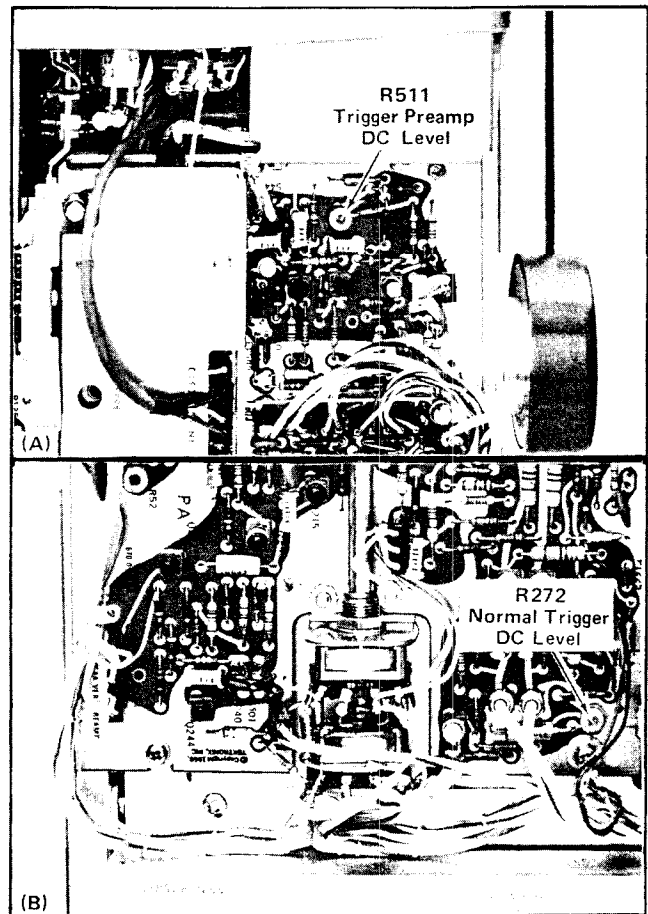

Fig. 5-15. (A) Location of Trigger Preamp DC Level and (B) Normal Trigger DC Level adjustments.

## HORIZONTAL SYSTEM ADJUSTMENT

### Equipment Required

- |   |  |
|---|--|
| <ol style="list-style-type: none"> <li>1. Medium-Frequency Constant-Amplitude Signal Generator (Type 191)</li> <li>2. Time-Mark Generator (Type 2901)</li> <li>3. Standard Amplitude Calibrator (067-0502-01)</li> <li>4. GR 5 Nanosecond Cable</li> <li>5. 42-Inch 50 <math>\Omega</math> BNC Cable</li> </ol> | <ol style="list-style-type: none"> <li>6. GR 50 <math>\Omega</math> In-Line Termination</li> <li>7. Dual-Input Coupler</li> <li>8. Three-Inch Screwdriver</li> <li>9. Low-Capacitance Screwdriver</li> <li>10. Tuning Tool With Insert For 5/64-Inch ID Hex Cores</li> </ol> |
|---|--|

### Control Settings

Preset instrument controls to the settings given under Preliminary Control Settings.

### 26. Adjust Sweep Start and A Sweep Calibration

a. Set the CH 1 VOLTS/DIV switch to .5, the HORIZ DISPLAY switch to A INTEN DURING B, the B SWEEP MODE switch to B STARTS AFTER DELAY TIME, and the DELAY-TIME MULTIPLIER dial to 1.00.

b. Apply 1 millisecond time markers to the CH 1 Input connector from the 2901 Time Mark Generator through a 42-inch 50  $\Omega$  BNC cable.

c. Adjust the A TRIGGERING LEVEL control for a stable display.

d. CHECK—Intensified portion of display starts at second marker.

e. ADJUST—Sweep Start adjustment R943 (see Fig. 5-16A) so intensified portion starts at second marker (preliminary adjustment).

f. Set DELAY-TIME MULTIPLIER dial to 9.00.

g. CHECK—Intensified portion of display starts at tenth marker.

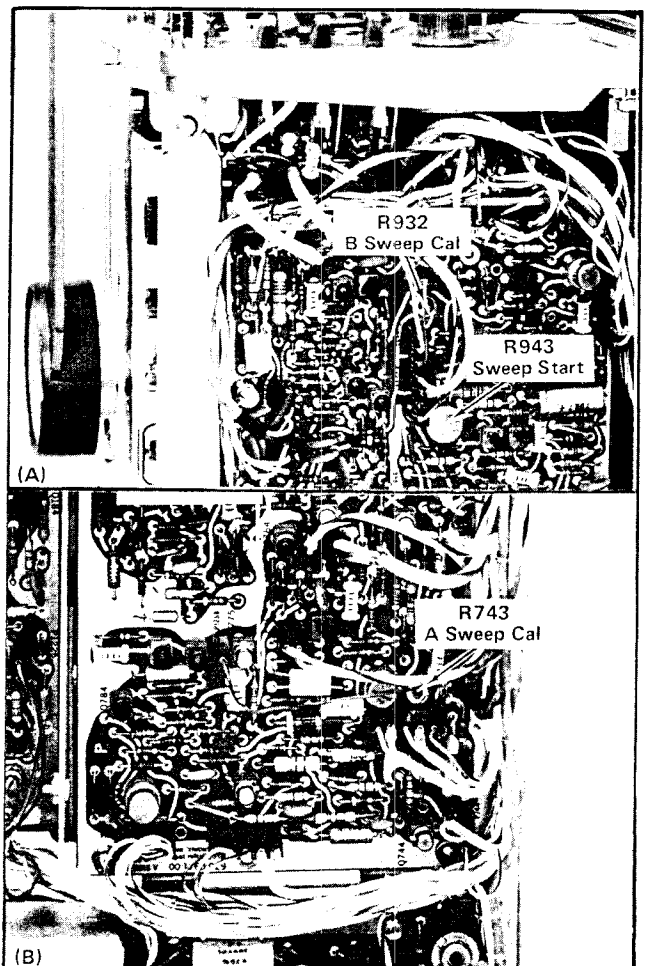

Fig. 5-16. (A) Location of Sweep Start and B Sweep Cal adjustments (B Sweep circuit board) and (B) A Sweep Cal adjustment (A Sweep circuit board).



h. ADJUST—A Sweep Cal adjustment R743 (see Fig. 5-16B) so intensified portion starts at tenth marker.

i. Set the HORIZ DISPLAY switch to B (DELAYED SWEEP).

j. Set the DELAY-TIME MULTIPLIER dial to 1.00.

k. CHECK—Displayed pulse starts at the beginning of the sweep.

l. ADJUST—Sweep Start adjustment R943 so displayed pulse starts at the beginning of the sweep.

m. Set the DELAY-TIME MULTIPLIER dial to 9.00.

n. CHECK—Displayed pulse starts at the beginning of the sweep.

o. ADJUST—A Sweep Cal adjustment R743 so displayed pulse starts at the beginning of the sweep.

p. Recheck parts j through o and readjust if necessary.

## 27. Adjust Normal Gain

a. Set the HORIZ DISPLAY switch to A.

b. CHECK—CRT display for one marker each division between the first- and ninth-division vertical lines.

### NOTE

*Unless otherwise noted, use the middle eight horizontal divisions when checking or adjusting timing.*

c. ADJUST—Normal Gain adjustment, R1024 (see Fig. 5-17), for one marker each division. The second and tenth markers must coincide exactly with their respective graticule lines (reposition the display slightly with the horizontal POSITION control if necessary).

d. Position the second marker to the first-division vertical line.

e. CHECK—Fourth marker within 0.1 division (within 5%) of the third-division vertical line.

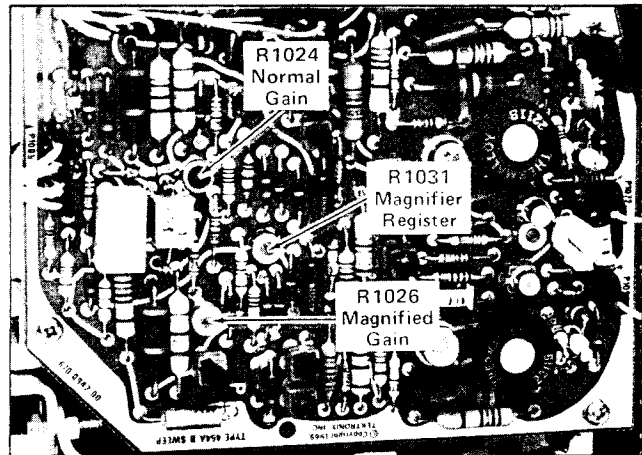

Fig. 5-17. Location of Normal Gain, Magnified Gain and Magnifier Register adjustments (B Sweep circuit board).

f. Position the third marker to the second-division vertical line.

g. CHECK—Fifth marker within 0.1 division (within 5%) of the fourth-division vertical line.

h. Continue this check for each two-division portion of the sweep within the center eight divisions of the graticule.

i. INTERACTION—Check steps 28 and 33.

## 28. Adjust Magnified Gain

a. Set the time-mark generator for 0.1-millisecond markers.

b. Set the MAG switch to X10.

c. CHECK—CRT display for one marker each division between the first- and ninth-division vertical lines.

d. ADJUST—Mag Gain adjustment, R1026 (see Fig. 5-17), for one marker each division. The second and tenth markers must coincide exactly with their respective graticule lines (reposition the display slightly with the horizontal FINE control if necessary).

e. Position the first eight-division portion of the total magnified sweep onto the viewing area.

## Adjustment—454A/R454A

f. CHECK—One marker each division between the first- and ninth-division vertical lines; marker at ninth-division vertical line must be within 0.32 division (within 4%) of the line when the marker at the first-division vertical line is positioned exactly.

g. Repeat this check for each eight division portion of the total magnified sweep length.

h. Set the horizontal POSITION and FINE controls to midrange.

i. Position a marker to the first-division vertical line.

j. CHECK—Marker within 0.1 division (within 5%) of the third-division vertical line.

k. Position the marker nearest the second-division vertical line to that line.

l. CHECK—Marker within 0.1 division (within 5%) of the fourth-division vertical line.

m. Continue this check for each two-division portion of the displayed sweep within the center eight divisions of the graticule.

n. INTERACTION—Check step 33.

## 29. Adjust Magnifier Register

a. Set the time-mark generator for five-millisecond markers.

b. Position the middle marker (three markers on total magnified sweep) to the center vertical line.

c. Set the MAG switch to OFF.

d. CHECK—Middle marker should remain at the center vertical line.

e. ADJUST—Mag Register adjustment R1031 (see Fig. 5-17), to position the middle marker to the center vertical line.

f. Set the MAG switch to X10.

g. Repeat parts b through e until no shift occurs when the MAG switch is set to OFF.

## 30. Adjust B Sweep Calibration

a. Set the DELAY-TIME MULTIPLIER dial to 0.10, the B TIME/DIV switch to 1 ms, the B SWEEP MODE switch to TRIGGERABLE AFTER DELAY TIME, the HORIZ DISPLAY switch to B (DELAYED SWEEP), and the MAG switch to OFF.

b. Set the time-mark generator for one-millisecond markers.

c. Set the B TRIGGERING LEVEL control for a stable display.

d. CHECK—CRT display for one marker each division between the first and ninth division vertical lines.

e. ADJUST—B Sweep Cal adjustment, R932 (see Fig. 5-16A), for one marker each division.

f. Position the second marker to the first-division vertical line.

g. CHECK—Fourth marker within 0.1 division (within 5%) of the third-division vertical line.

h. Position the third marker to the second-division vertical line.

i. CHECK—Fifth marker within 0.1 division (within 5%) of the fourth-division vertical line.

j. Continue this check for each two-division portion of the sweep within the center eight divisions of the graticule.

## 31. Adjust A and B One Microsecond Timing

a. Set the A and B TIME/DIV switch to 1  $\mu$ s and the HORIZ DISPLAY switch to A.

b. Set the time-mark generator for one-microsecond markers.

c. Adjust the A TRIGGERING LEVEL control for a stable display.

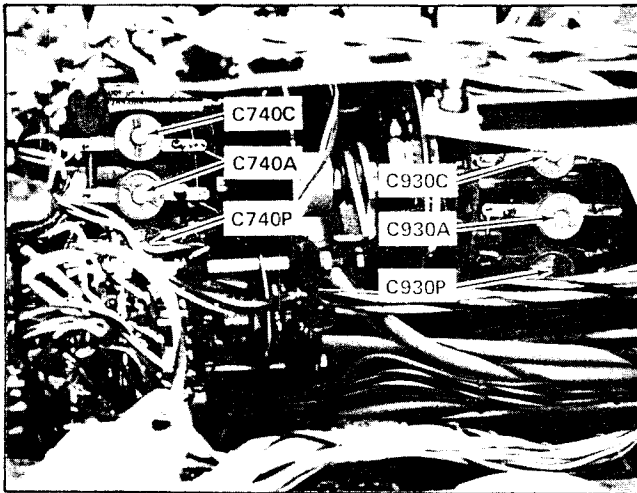

Fig. 5-18. Location of A and B Sweep timing adjustments A and B TIME/DIV switch (behind swing-out side panel).

d. CHECK—CRT display for one marker each division between the first and ninth division vertical lines.

e. ADJUST—C740C (see Fig. 5-18) for one marker each division.

f. Set the HORIZ DISPLAY switch to B (DELAYED SWEEP).

g. Adjust the B TRIGGERING LEVEL control for a stable display and the DELAY-TIME MULTIPLIER dial to 0.10.

h. CHECK—CRT display for one marker each division between the first and ninth division vertical lines.

i. ADJUST—C930C (see Fig. 5-18) for one marker each division.

### 32. Adjust A and B 0.1 Microsecond Timing

a. Set the A and B TIME/DIV switches to  $.1 \mu\text{s}$ .

b. Set the time-mark generator for 0.1-microsecond markers.

c. CHECK—CRT display for one marker each division between the first- and ninth-division vertical lines.

d. ADJUST—C930A (see fig. 5-18) for one marker each division.

e. Set the HORIZ DISPLAY switch to A.

f. CHECK—CRT display for one marker each division between the first- and ninth-division graticule lines.

g. ADJUST—C740A (see Fig. 5-18) for one marker each division.

### 33. Adjust A and B High-Speed Timing and Linearity

a. Set the HORIZ DISPLAY switch to A and the A and B TIME/DIV switches to  $.05 \mu\text{s}$ .

b. Apply a 50 ns sine wave from the time-mark generator.

c. CHECK—CRT display for one cycle/division.

d. ADJUST—C740P (see Fig. 5-18) for one cycle/division.

e. Set the A TIME/DIV switch to  $.02 \mu\text{s}$  and the MAG switch to X10.

f. Apply a 10 nanosecond sine wave from the time-mark generator.

g. Connect  $.1 \mu\text{s}$  triggers to the A EXT TRIG INPUT connector via a 42-inch  $50 \Omega$  BNC cable.

h. Set the A TRIGGERING SOURCE switch to EXT and adjust the A TRIGGERING LEVEL and HF STAB controls for a stable display.

i. CHECK—CRT display for 1 cycle in 5 divisions near the center of the CRT.

j. ADJUST—R1095 (see Fig. 5-19) for 1 cycle in 5 divisions near the center of the CRT.

k. Change the A TIME/DIV switch to  $.05 \mu\text{s}$ .

l. CHECK—CRT display for 1 cycle in 2 divisions over the center 8 divisions.

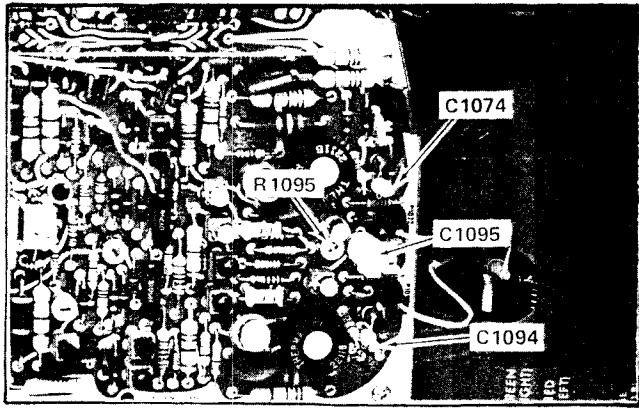

Fig. 5-19. Location of Horizontal Amplifier high-speed linearity adjustments (B Sweep circuit board).

m. ADJUST—C1095 (see Fig. 5-19) for 1 cycle in 2 divisions over the center 8 divisions.

n. Repeat steps b through m until no significant improvement in timing can be made. The setting of C740P may have to be compromised to obtain optimum timing in the .05  $\mu$ s and .02  $\mu$ s positions of the TIME/DIV switch. C1074 and C1094 should be adjusted for best linearity when viewing the first and last of a magnified display at the two fastest sweep rates. They should be adjusted approximately equal amounts.

o. Set the HORIZ DISPLAY switch to B (DELAYED SWEEP), the B TIME/DIV switch to .05  $\mu$ s, and the MAG switch to OFF.

p. Apply a 50 nanosecond sine wave from the time-mark generator.

q. Adjust the B TRIGGERING LEVEL control for a stable display.

r. CHECK—CRT display for 1 cycle/division.

s. ADJUST—C930P (see Fig. 5-18) for 1 cycle/division.

t. Change the B TIME/DIV switch to .02  $\mu$ s.

u. Apply a 10 nanosecond sine wave from the time-mark generator.

v. CHECK—CRT display for 2 cycles/division.

w. ADJUST—The setting of C930P may have to be compromised to obtain optimum timing in the .05  $\mu$ s and .02  $\mu$ s positions of the B TIME/DIV switch.

x. Disconnect all test equipment.

### 34. Adjust X Gain

a. Set the HORIZ DISPLAY switch to X-Y, the INT TRIG switch to CH 1 ONLY OR X-Y, the CH 1 and CH 2 VOLTS/DIV switches to 10 mV/DIV, the CH 1 Input Coupling switch to DC and the CH 2 Input Coupling switch to GND.

b. Apply a 50 mV square wave signal from the 067-0502-01 Standard Amplitude Calibrator to the CH 1 OR X input connector through a 42-inch 50  $\Omega$  BNC cable.

c. CHECK—CRT display for 5 divisions of deflection between the two displayed dots.

d. ADJUST—X-GAIN (X-Y) adjustment (on instrument side panel) for exactly 5 divisions of deflection between the two dots displayed on the CRT.

e. Disconnect all test equipment.

### 35. Adjust X-Y Phasing

a. Connect the output of the medium-frequency signal generator (Type 191) to the CH 1 and CH 2 input connectors through the five-nanosecond GR cable, a GR 50-ohm in-line termination and a dual-input coupler.

b. Set the CH 2 VOLTS/DIV switch to 20 mV/DIV, the A SWEEP MODE switch to NORM TRIG, and the A TRIGGERING LEVEL control fully clockwise.

c. Set the medium-frequency generator for a 10-division horizontal display at about one megahertz.

d. Center the display vertically and horizontally with the CH 1 and CH 2 POSITION controls.

e. CHECK—CRT display for an opening at the center horizontal line of 0.52 division or less ( $3^\circ$  or less phase shift; see Fig. 5-20A).

f. ADJUST—Horizontal Delay Compensation adjustment, R569 (see Fig. 5-20B) for minimum opening of the display at the center of the horizontal line.

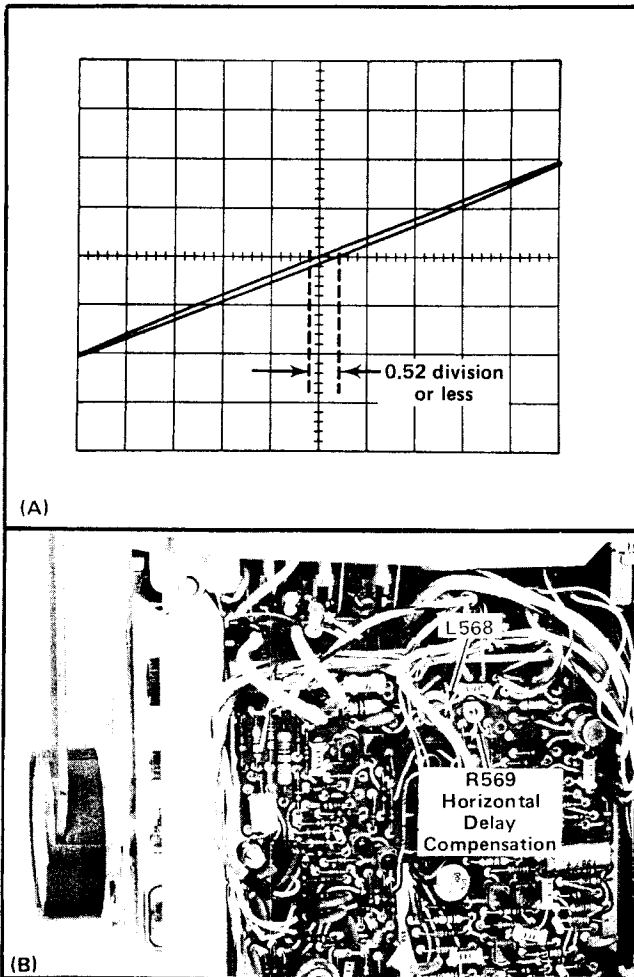

Fig. 5-20. (A) Typical CRT display when checking X-Y phasing. (B) Location of X-Y Phasing adjustments (on B Sweep circuit board).

g. Set the medium-frequency generator for a 10-division horizontal display at two megahertz.

h. If necessary, recenter the display with the CH 1 and CH 2 POSITION controls.

i. CHECK—CRT display for an opening at the center horizontal line of 0.52 division or less ( $3^\circ$  or less phase shift; see Fig. 5-20A).

j. ADJUST—L568 (see Fig. 5-20B) for minimum opening of the display at the center horizontal line.

k. Repeat parts c through j until optimum phasing is obtained.

l. Set the medium-frequency generator for a 10-division horizontal display at about 0.5 megahertz.

m. If necessary, recenter the display with the CH 1 and CH 2 POSITION controls.

n. CHECK—CRT display for an opening at the center horizontal line of 0.52 division or less ( $3^\circ$  or less phase shift; see Fig. 5-20A).

o. ADJUST—Compromise the adjustment of R569 at 0.5 and one megahertz for optimum phasing at both frequencies.

p. If R569 is adjusted in part o, repeat parts c through n until optimum phasing is obtained.

This completes the Calibration Procedure for the 454A. Disconnect all test equipment and secure the swing-out side panel. Replace the top and bottom covers.

## NOTES

For Service Management Contact  
MATHIEUX  
E: [mathieus@mathieus.com](mailto:mathieus@mathieus.com)  
Tel: 01044-351034 Fax: 01044-352554  
Email: [mathieus@mathieus.com](mailto:mathieus@mathieus.com)

# SECTION 6

## RACKMOUNTING

*Change information, if any, affecting this section will be found at the rear of this manual.*

### Introduction

The Tektronix R454A Oscilloscope is designed to mount in a standard 19-inch rack. When mounted in accordance with the following mounting procedure this instrument will meet all electrical and environmental characteristics given in Section 1 of this manual.

### Rack Dimensions

**Height.** At least seven inches of vertical space is required to mount this instrument in a cabinet rack.

**Width.** Minimum width of the opening between the left and right front rails of the rack must be 17 5/8 inches. This allows room on each side of the instrument for the slide-out tracks to operate freely, permitting the instrument to move smoothly in and out of the rack.

**Depth.** Total depth necessary to mount the R454A in a cabinet rack is 19 3/8 inches. This allows room for air circulation, power cord and the necessary mounting hardware.

### Slide-Out Tracks

Fig. 6-1 shows the R454A installed in a cabinet-type rack. The slide-out tracks provided with the R454A permit it to be extended out of the rack for maintenance or calibration without removing the instrument from the rack. In the fully extended position, the R454A can be tilted up so the bottom of the instrument can be reached for maintenance or calibration. To operate the R454A in the extended position, be sure the power cord and any interconnecting cables are long enough for this purpose. When not extended, the instrument is held in the rack with four securing screws (see Fig. 6-1A).

The slide-out tracks consist of two assemblies—one for the left side of the instrument and one for the right side. Fig. 6-2 shows the complete slide-out track assemblies. The stationary section of each assembly attaches to the front and rear rails of the rack, and the chassis section is attached to the instrument. The intermediate section slides between the stationary and chassis sections and allows the R454A to be extended out of the rack. When the instrument is

shipped, the stationary and intermediate sections of the tracks are packaged as matched sets and should not be separated. To identify the left or right assembly, note the position of the automatic latch (see Fig. 6-2). When mounted in the rack, the automatic latch should be at the top of both assemblies. The chassis sections are installed on the instrument at the factory.

The hardware provided for mounting the slide-out tracks is shown in Fig. 6-3. Since the hardware is intended to make the tracks compatible with a variety of cabinet racks and installation methods, not all of it will be needed for this installation. Use only the hardware that is required for the mounting method used.

### Mounting Procedure

The following mounting procedure uses the rear support kit (see Fig. 6-4 and 6-7) to meet the environmental characteristics of the instrument (shock and vibration). Two alternative mounting methods are described at the end of this procedure. However, when mounted according to these alternative methods, the instrument may not meet the given environmental characteristics for shock and vibration.

The front flanges of the stationary sections may be mounted in front of (outside) or behind (inside) the front rails of the rack, depending on the type of rack. If the front rails of the rack are tapped for 10-32 screws, the front flanges are mounted outside of the rails. If the front rails of the rack are not tapped for 10-32 screws, the front flanges are mounted inside the front rail and a bar nut is used. Fig. 6-5 shows these methods of mounting the stationary sections.

The rear of the stationary sections must be firmly supported to provide a shock-mounted installation. This rear support must be located 17.471 inches,  $\pm 0.031$  inch, from the outside surface of the front rail when the mounting flange is mounted outside of the rail, or 17.531 inches,  $\pm 0.031$  inch, from the rear surface of the front rail when the mounting flange is mounted inside of the front rail. If the cabinet rack does not have a strong supporting member located the correct distance from the front rail, an additional support must be added. The instrument will not meet the environmental specifications unless firmly supported at

this point. Fig. 6-4 illustrates a typical rear installation using the rear support kit and gives the necessary dimensions.

Use the following procedure to install the R454A in a rack:

1. Select the proper front-rail mounting holes for the stationary sections using the measurements shown in Fig. 6-4.

2a. If the mounting flanges of the stationary sections are to be mounted in front of the front rails (rails tapped for 10-32 screws), mount each stationary section as shown in Fig. 6-5A.

2b. If the mounting flanges of the stationary sections are to be mounted behind the front rails (rails not tapped for 10-32 screws), mount each stationary section as shown in Fig. 6-5B.

3. Attach an angle bracket to both rear rails of the rack through the spacer block, stationary section and into the rear rail of the rack. Note that the holes in the spacer block are not centered. Be sure to mount the block with the narrow edge toward the front of the rack; otherwise, the instrument may not slide all the way into the rack. Do not tighten the mounting screws. Fig. 6-7 shows the parts in the rear support kit and the order in which they are assembled.

4. Assemble the support pin to the angle bracket in the order shown in Fig. 6-7. Leave the spacer (washer) off, but install the neoprene washer.

5. Install a support block on each side of the instrument as shown in Fig. 6-8.

6. Refer to Fig. 6-9 to insert the instrument into the rack. Do not connect the power cord or install the securing screws until all adjustments have been made.

7. With the instrument pushed all the way into the rack, adjust the angle bracket so the neoprene washers on the support pins are seated firmly against the rear of the instrument and the support pins are correctly positioned in the support block on the rear of the instrument. Tighten all screws.

8. Pull the instrument partially out of the rack.

9. Remove the neoprene washers from the support pins and place the spacers on the pins. Replace the neoprene washers.

10. Position the instrument so the pivot screws (widest part of instrument) are approximately even with the front rails.

11. Adjust the alignment of the stationary sections according to the procedure outlined in Fig. 6-10. (If the rear alignment is changed, recheck the rear support pins for correct alignment.)

12. After the tracks operate smoothly, connect the power cord to the power source.

13. Push the instrument all the way into the rack and secure it to the rack with the securing screws and washers as shown in Fig. 6-9C.

#### NOTE

*The securing screws are an important part of the shock-mounted installation. If the front rails are not tapped for the 10-32 securing screws, other means must be provided for securing the instrument to the rack.*

#### Alternative Rear Mounting Methods

##### CAUTION

*Although the following methods provide satisfactory mounting under normal conditions, they do not provide solid support at the rear of the instrument. If the instrument is subjected to severe shock or vibration when mounted using the following methods, it may be damaged.*

An alternative method of supporting the rear of the instrument is shown in Fig. 6-11. The rear support brackets supplied with the instrument allow it to be mounted in a rack which has a spacing between the front and rear rails of 11 to 24 inches. Fig. 6-11A illustrates the mounting method if the rear rails are tapped for 10-32 screws, and Fig. 6-11B illustrates the mounting method if the rear rails are not tapped for 10-32 screws. The rear support kit is not used for this installation.

If the rack does not have a rear rail, or if the distance between the front and rear rails is too large, the instrument may be mounted without the use of the slide-out tracks.





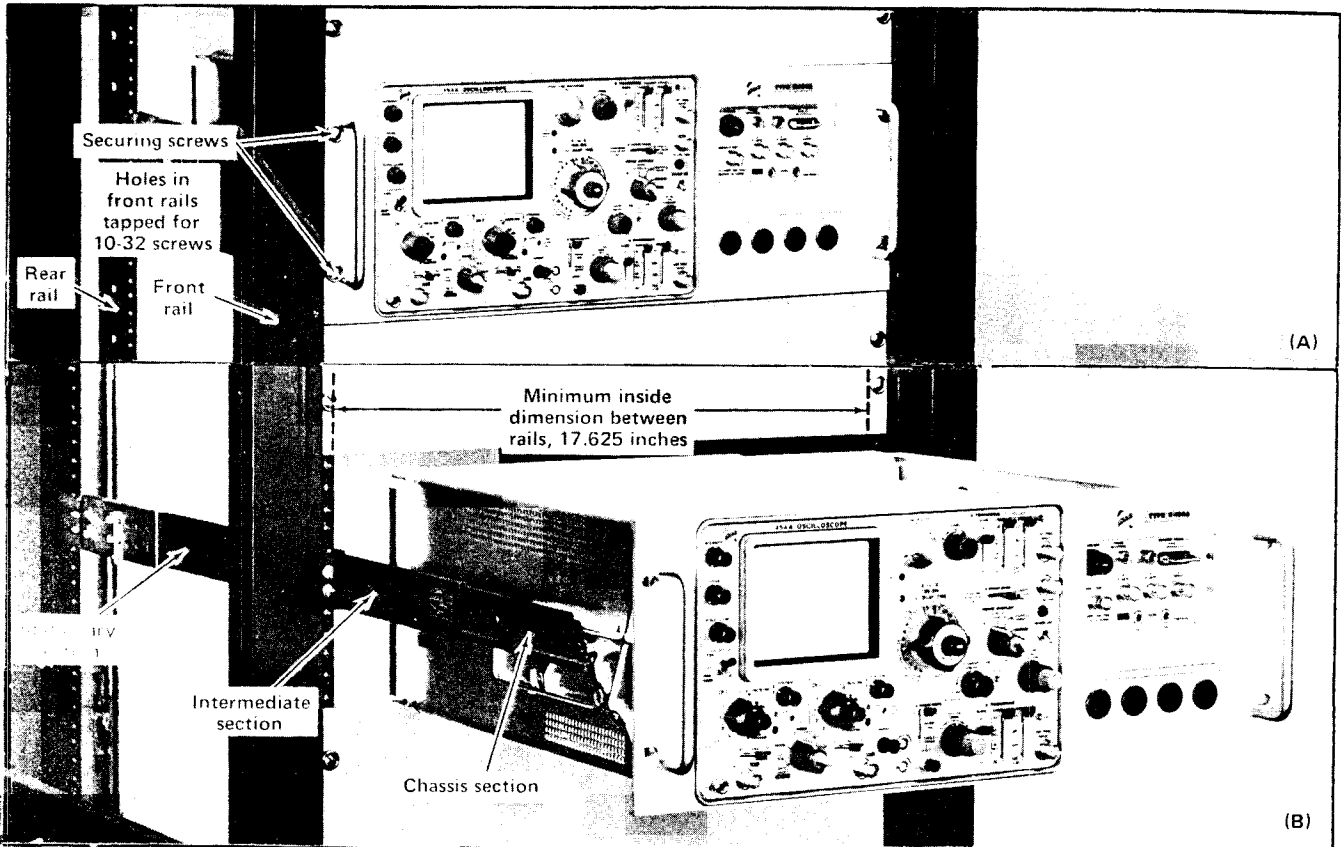

Fig. 6-1. The R454A installed in a cabinet rack (sides removed); (A) held into rack with securing screws, (B) extended on slideout tracks.

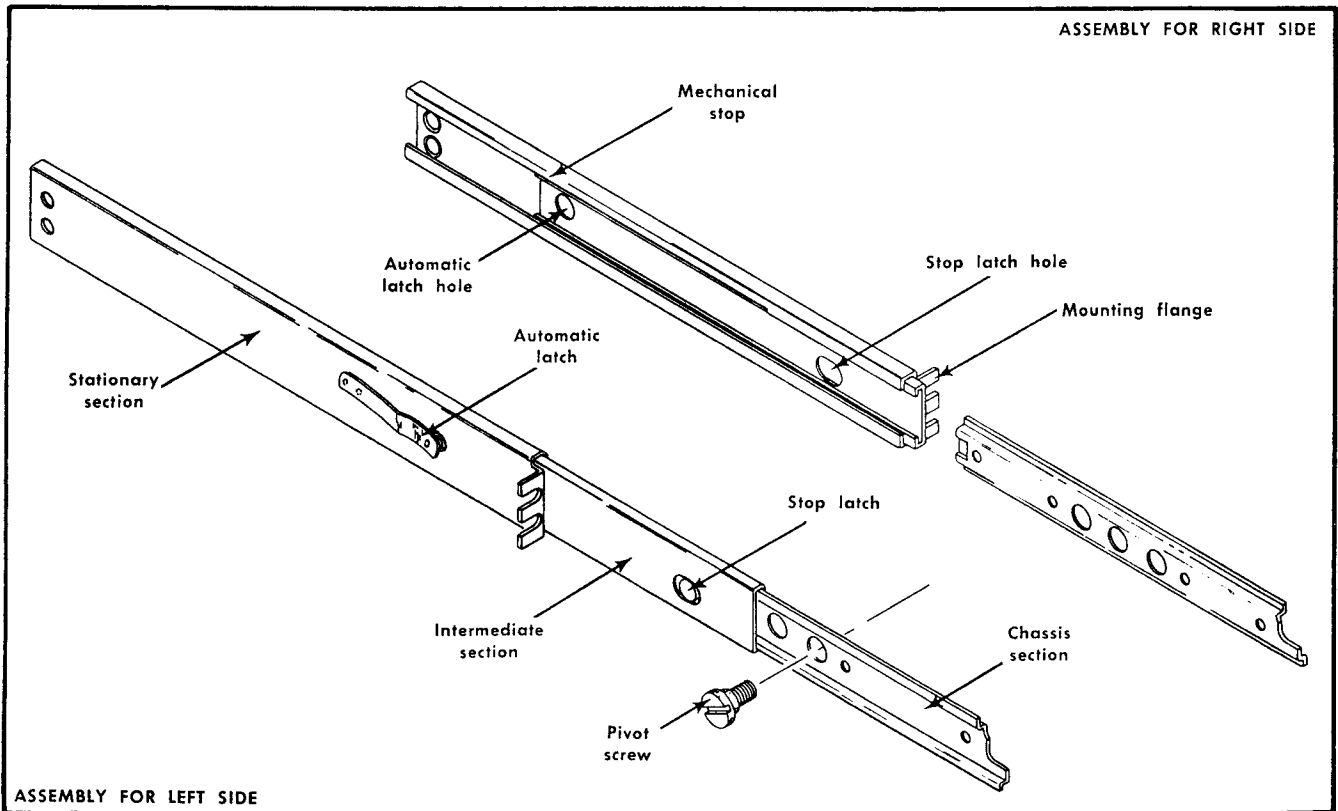

Fig. 6-2. Slideout track assemblies.

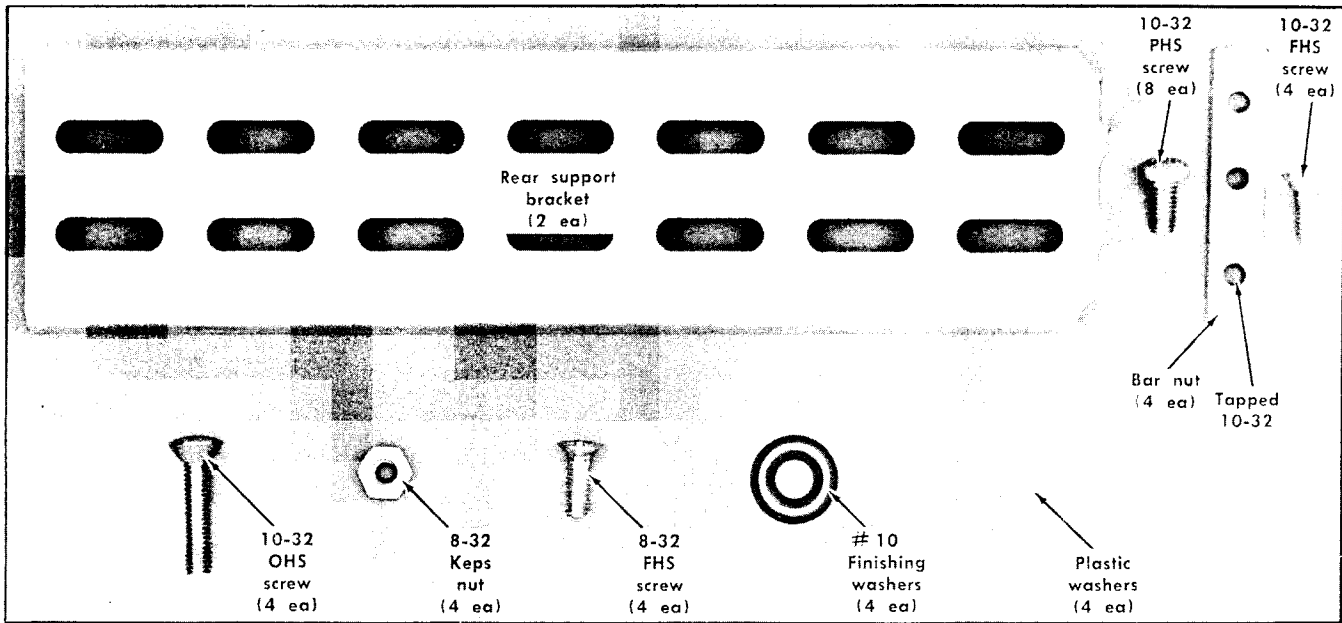

Fig. 6-3. Hardware needed to mount the instrument in the cabinet rack.

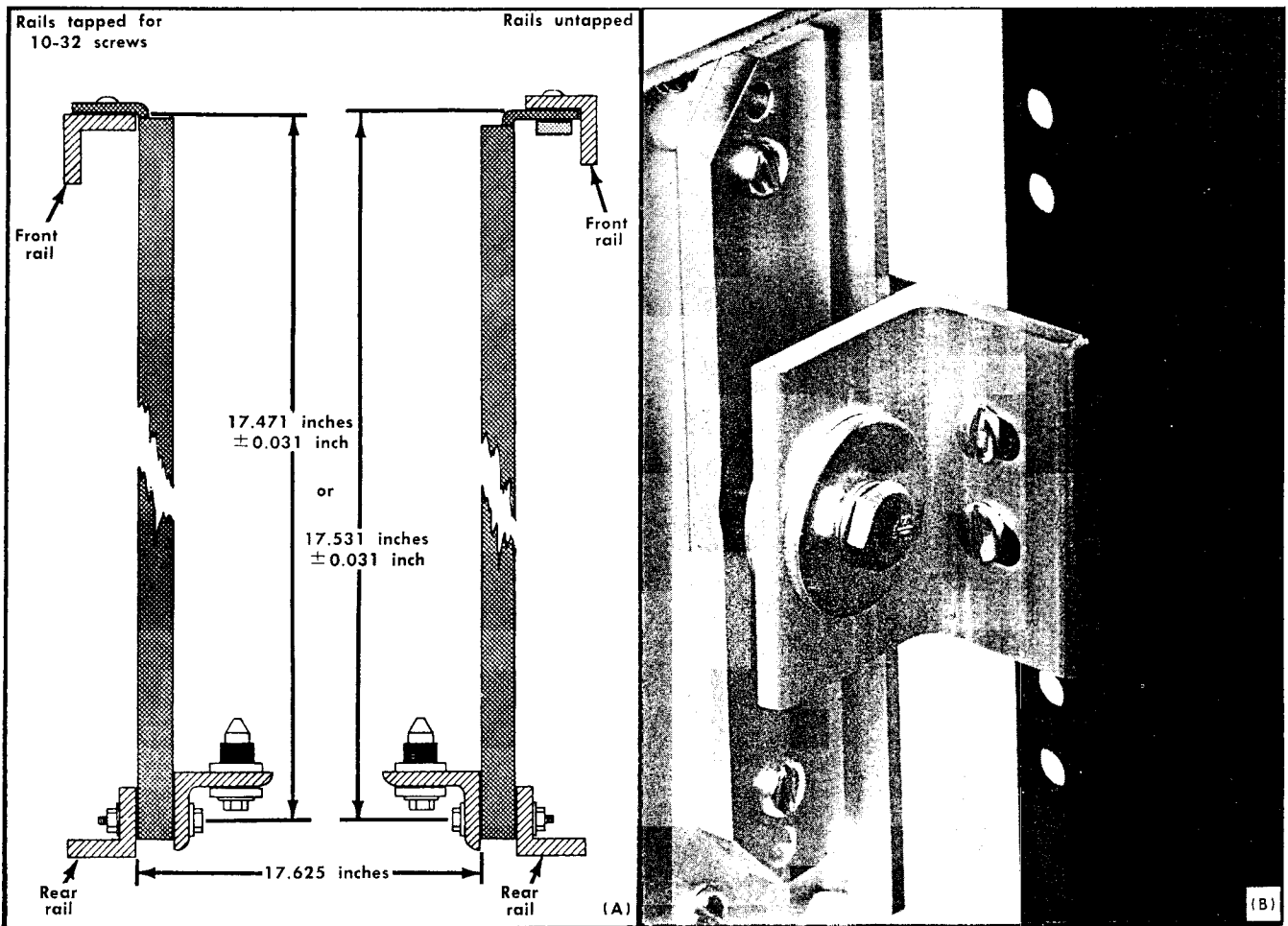

Fig. 6-4. Supporting the rear of the stationary sections; (A) dimensions necessary, (B) completed installation.

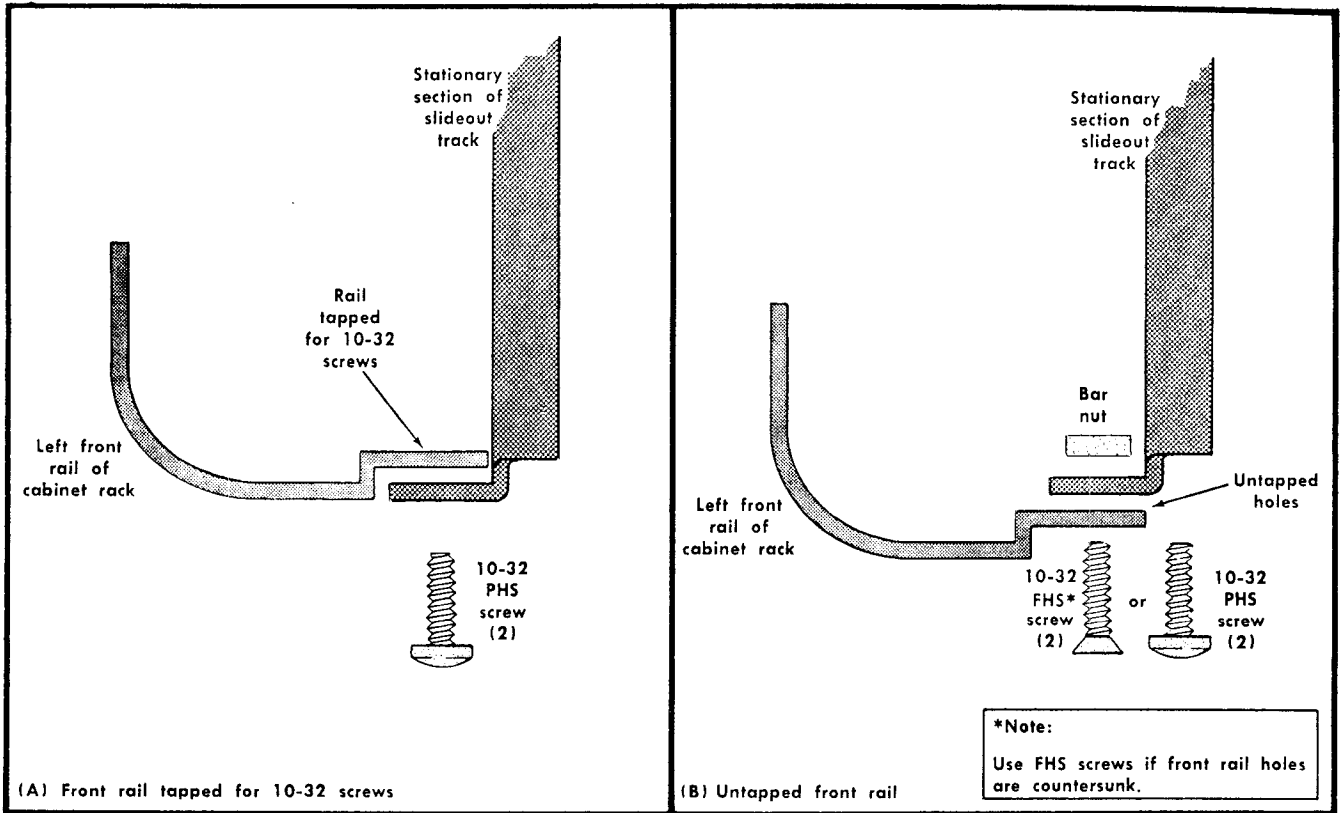

Fig. 6-5. Methods of mounting the stationary section to the front rails.

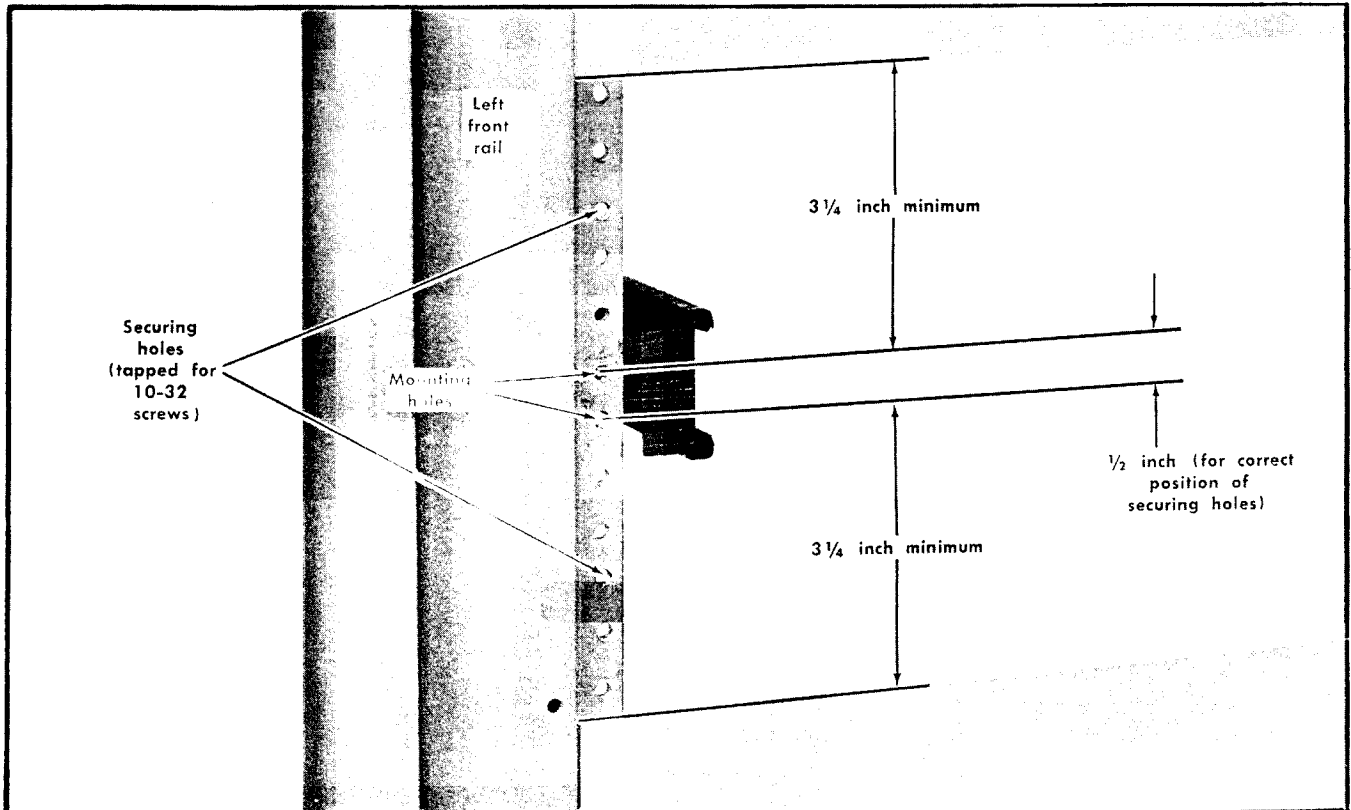

Fig. 6-6. Locating the mounting holes for the stationary sections. Same dimensions apply to right stationary section.

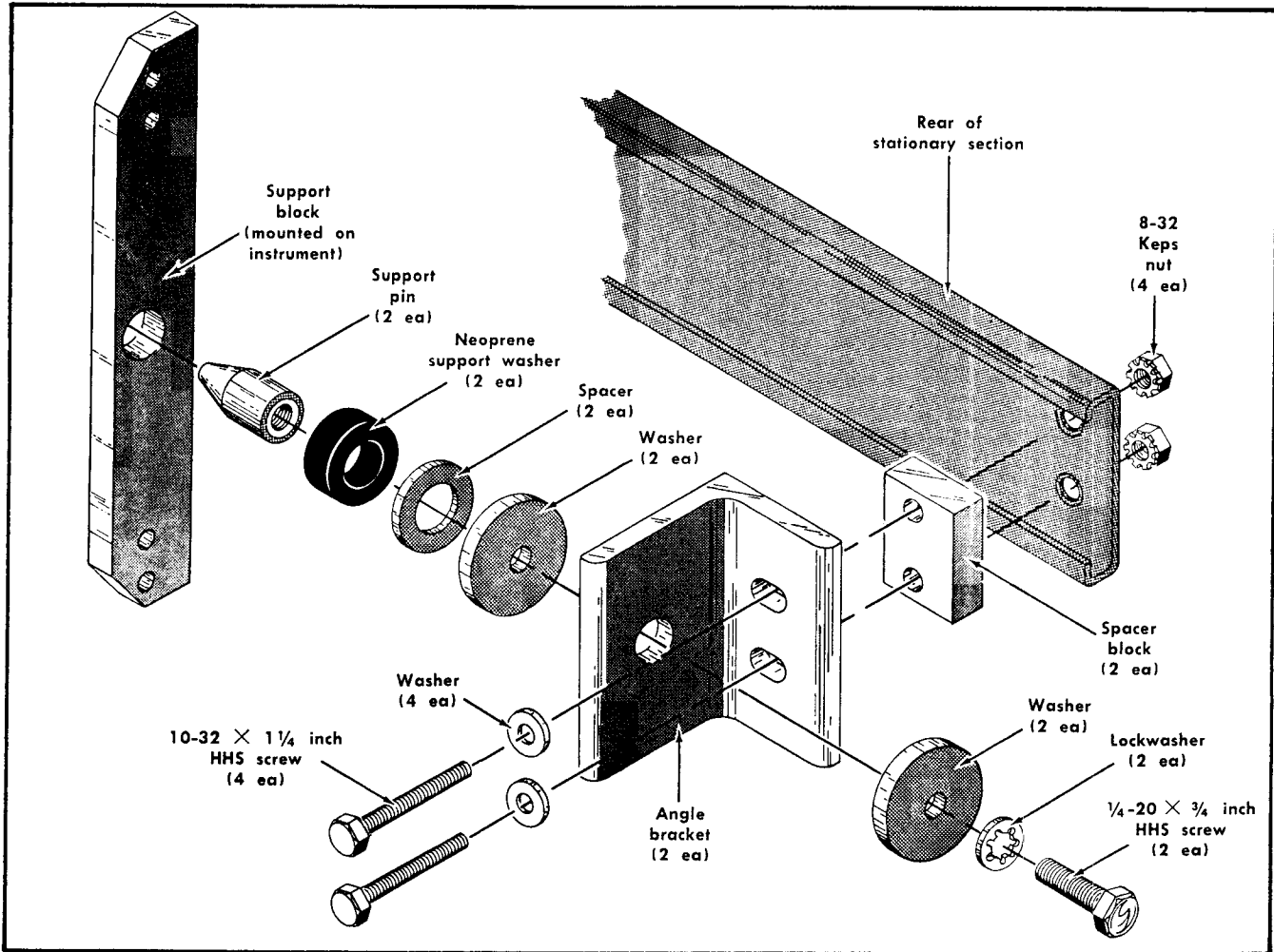

Fig. 6-7. Rear support kit.

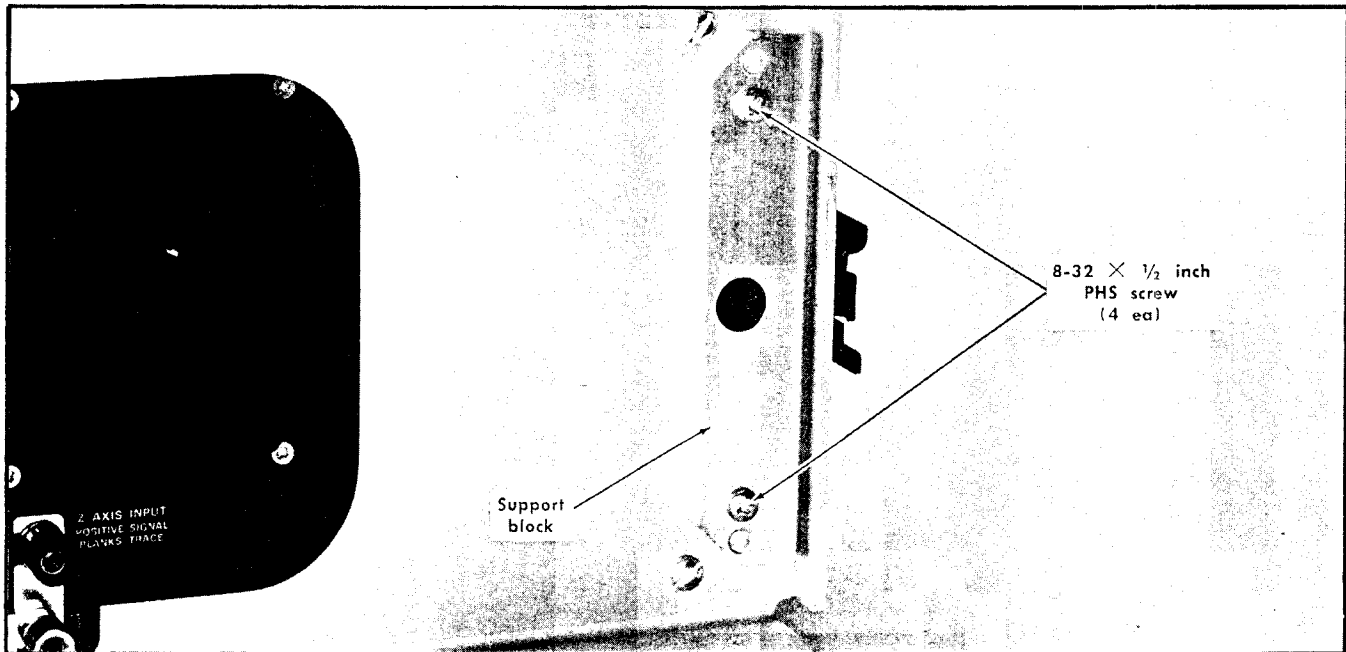
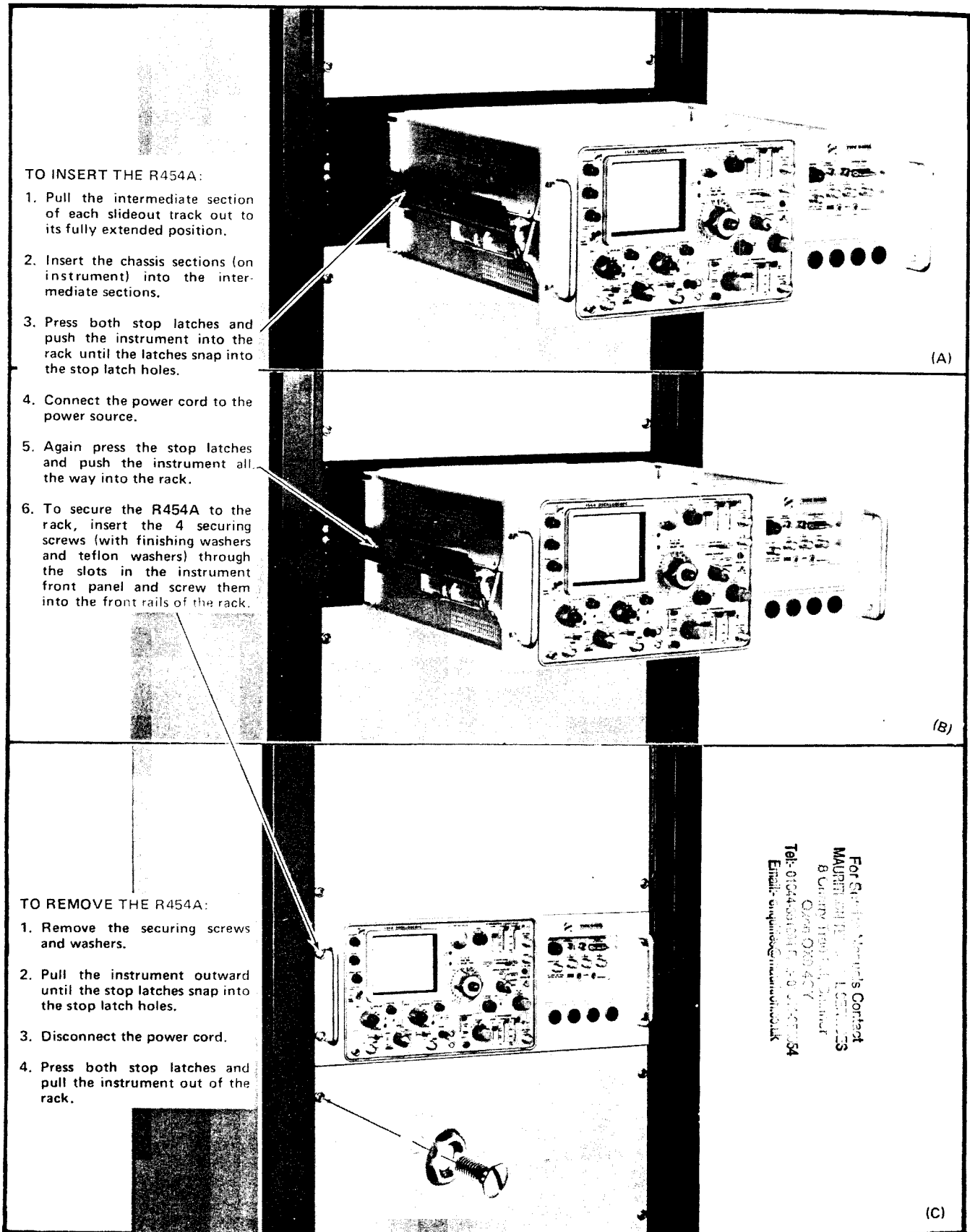

Fig. 6-8. Installing the support block on the instrument.



**TO INSERT THE R454A:**

1. Pull the intermediate section of each slideout track out to its fully extended position.
2. Insert the chassis sections (on instrument) into the intermediate sections.
3. Press both stop latches and push the instrument into the rack until the latches snap into the stop latch holes.
4. Connect the power cord to the power source.
5. Again press the stop latches and push the instrument all the way into the rack.
6. To secure the R454A to the rack, insert the 4 securing screws (with finishing washers and teflon washers) through the slots in the instrument front panel and screw them into the front rails of the rack.

(A)

(B)

**TO REMOVE THE R454A:**

1. Remove the securing screws and washers.
2. Pull the instrument outward until the stop latches snap into the stop latch holes.
3. Disconnect the power cord.
4. Press both stop latches and pull the instrument out of the rack.

(C)

For Service, Monitor's Contact:  
 MAURITIUS ELECTRONIC SERVICES  
 8 University Road, Mauritius  
 Open Office: 020 490 490  
 Tel: 01044000011 / 01044000054  
 Email: [enquiries@mauritiuselectronics.com](mailto:enquiries@mauritiuselectronics.com)

Fig. 6-9. Procedure for inserting or removing the instrument after the slideout tracks have been installed.

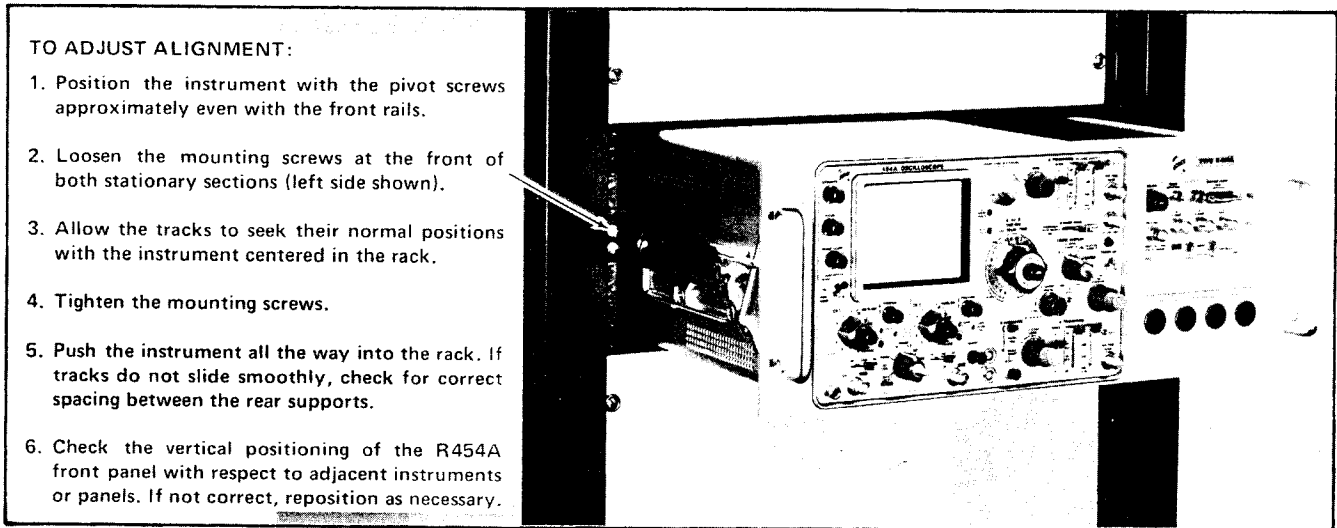

Fig. 6-10. Alignment adjustments for correct operation.

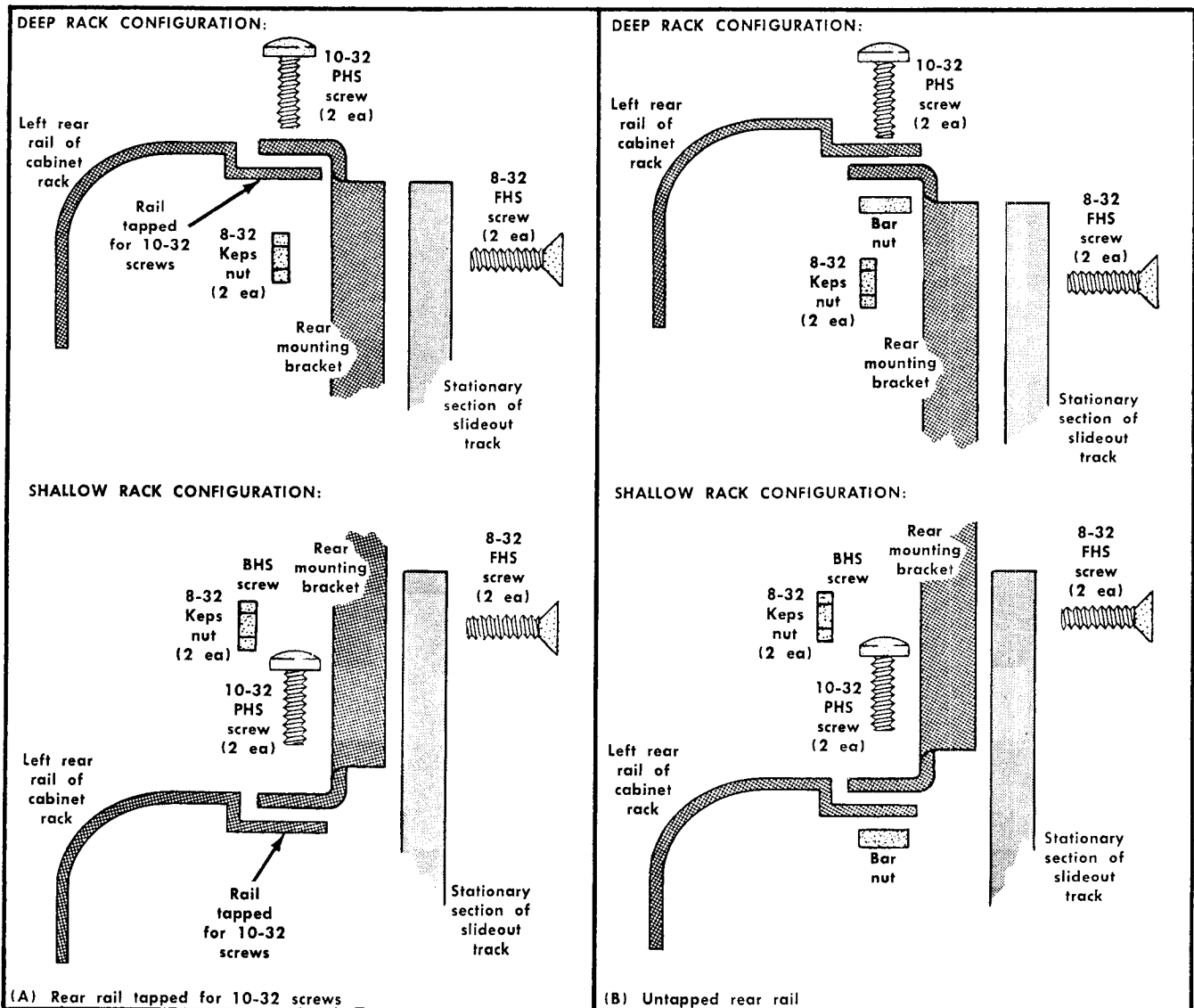
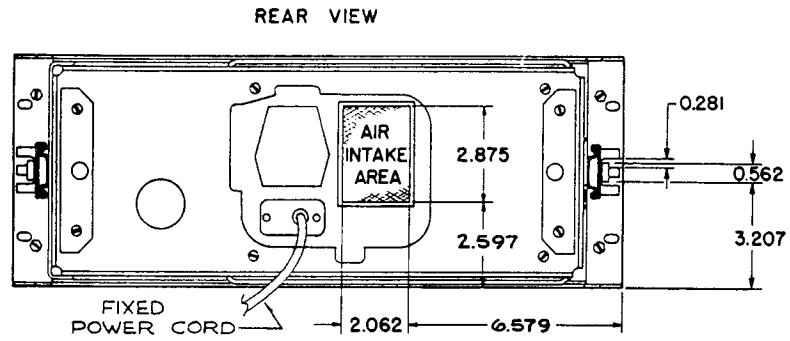
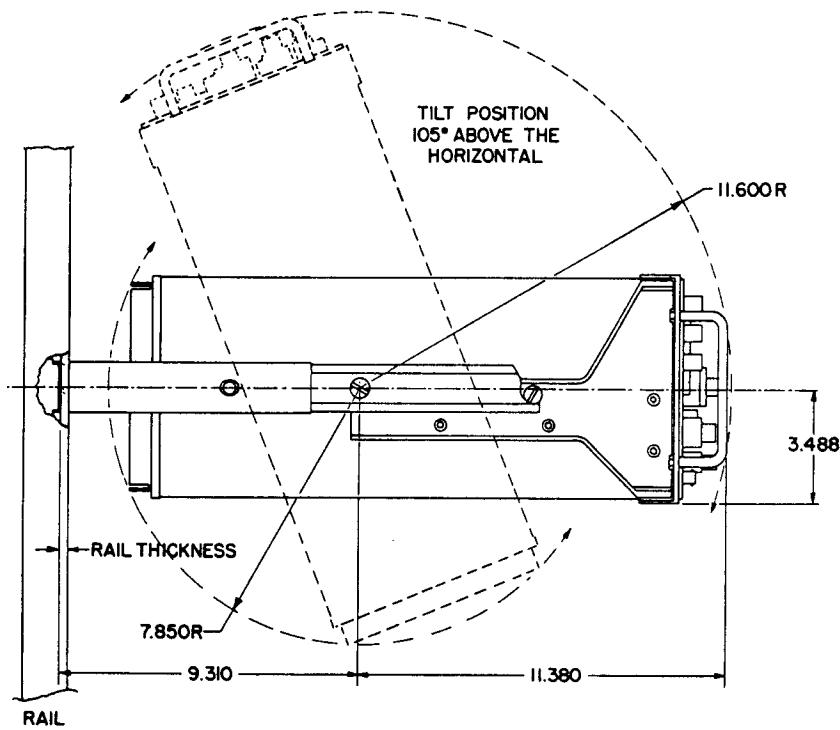

Fig. 6-11. Alternative method of installing the instrument using rear support brackets.



For Service Manuals Contact  
 MAURITRON TECHNICAL SERVICES  
 8 Cherry Tree Rd, Chinnor  
 Oxon OX9 4QY  
 Tel:- 01844-351604 Fax:- 01844-352554  
 Email:- enquiries@mauritron.co.uk



NOTES:  
 1. ALL DIMENSIONS ARE REFERENCE  
 DIMENSIONS EXCEPT AS NOTED

Fig. 6-12A. Dimensional drawing.



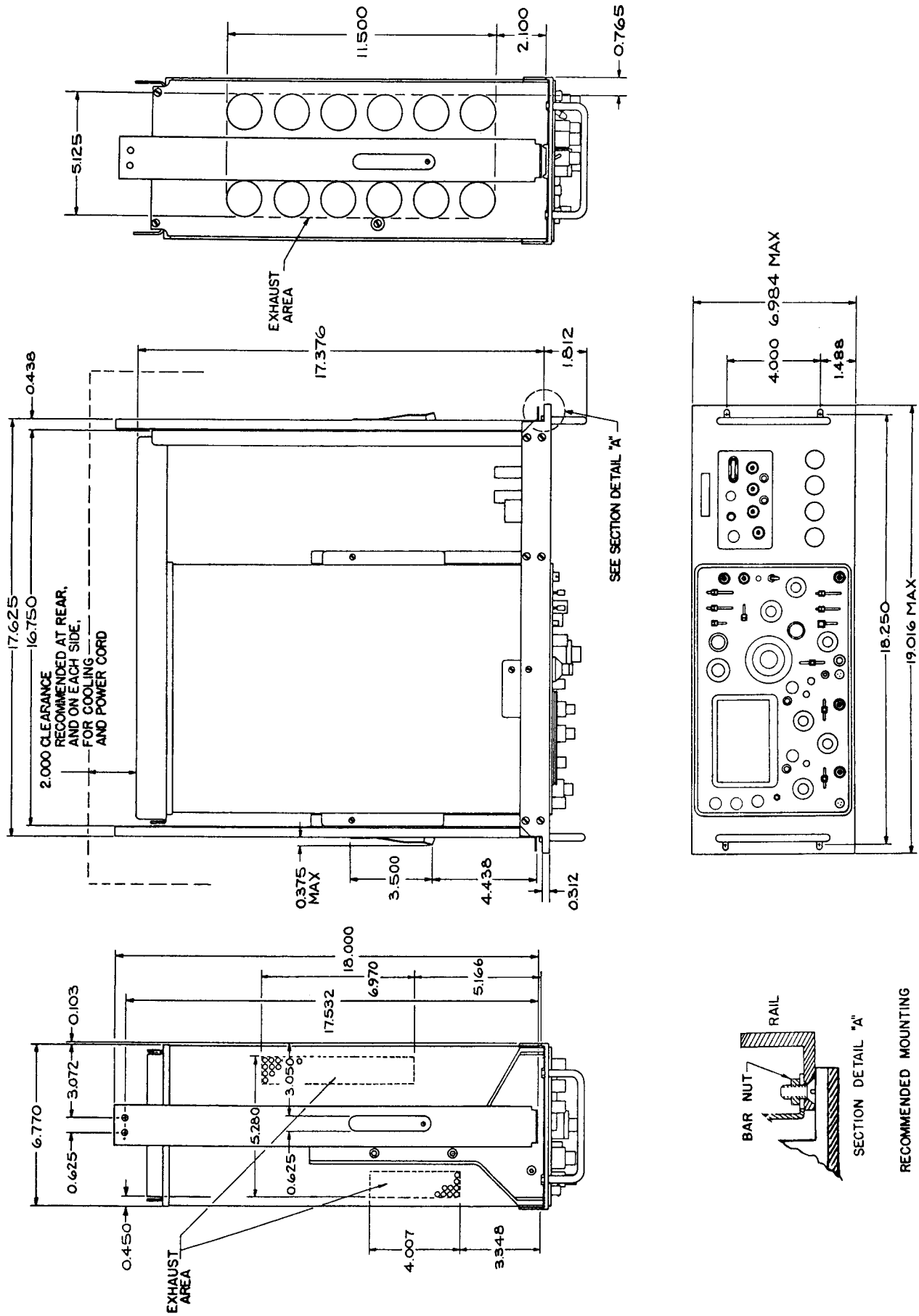

Fig. 6-12B. Dimensional drawing.

## PARTS LIST ABBREVIATIONS

BHB	binding head brass	int	internal
BHS	binding head steel	lg	length or long
cap.	capacitor	met.	metal
cer	ceramic	mtg hdw	mounting hardware
comp	composition	OD	outside diameter
conn	connector	OHB	oval head brass
CRT	cathode-ray tube	OHS	oval head steel
csk	countersunk	P/O	part of
DE	double end	PHB	pan head brass
dia	diameter	PHS	pan head steel
div	division	plstc	plastic
elect.	electrolytic	PMC	paper, metal cased
EMC	electrolytic, metal cased	poly	polystyrene
EMT	electrolytic, metal tubular	prec	precision
ext	external	PT	paper, tubular
F & I	focus and intensity	PTM	paper or plastic, tubular, molded
FHB	flat head brass	RHB	round head brass
FHS	flat head steel	RHS	round head steel
Fil HB	fillister head brass	SE	single end
Fil HS	fillister head steel	SN or S/N	serial number
h	height or high	S or SW	switch
hex.	hexagonal	TC	temperature compensated
HHB	hex head brass	THB	truss head brass
HHS	hex head steel	thk	thick
HSB	hex socket brass	THS	truss head steel
HSS	hex socket steel	tub.	tubular
ID	inside diameter	var	variable
inc	incandescent	w	wide or width
		WW	wire-wound

**For Service Manuals Contact**  
**MAURITRON TECHNICAL SERVICES**  
 8 Cherry Tree Rd, Chinnor  
 Oxon OX9 4QY  
 Tel: 01844-351694 Fax: 01844-352554  
 Email: enquiries@mauriton.co.uk

## PARTS ORDERING INFORMATION

Replacement parts are available from or through your local Tektronix, Inc. Field Office or representative.

Changes to Tektronix instruments are sometimes made to accommodate improved components as they become available, and to give you the benefit of the latest circuit improvements developed in our engineering department. It is therefore important, when ordering parts, to include the following information in your order: Part number, instrument type or number, serial or model number, and modification number if applicable.

If a part you have ordered has been replaced with a new or improved part, your local Tektronix, Inc. Field Office or representative will contact you concerning any change in part number.

## SPECIAL NOTES AND SYMBOLS

- ×000 Part first added at this serial number
- 00× Part removed after this serial number
- \*000-0000-00 Asterisk preceding Tektronix Part Number indicates manufactured by or for Tektronix, Inc., or reworked or checked components.
- Use 000-0000-00 Part number indicated is direct replacement.

**For Service Manuals Contact**  
**MAURITRON TECHNICAL SERVICES**  
8 Cherry Tree Rd, Chinnor  
Oxon OX9 4QY  
Tel: 01844-351694 Fax: 01844-352554  
Email: enquiries@maurifron.co.uk

**INDEX OF ELECTRICAL PARTS LIST**

<b>Title</b>	<b>Page No.</b>
Chassis .....	7-1
A1 VERTICAL PREAMP Circuit Board Assembly .....	7-12
A2 VERTICAL OUTPUT Circuit Board Assembly .....	7-20
A3 THICK FILM HYBRID Circuit Board Assembly .....	7-23
A4 A SWEEP Circuit Board Assembly .....	7-24
A5 B SWEEP Circuit Board Assembly .....	7-32
A6 CALIBRATOR Circuit Board Assembly .....	7-41
A7 LOW VOLTAGE REGULATOR Circuit Board Assembly .....	7-42
A8 Z AXIS Circuit Board Assembly .....	7-44

# SECTION 7

## ELECTRICAL PARTS LIST

Values are fixed unless marked Variable.

Ckt. No.	Tektronix Part No.	Serial/Model No. Eff	Disc	Description
<b>CHASSIS</b>				
<b>Motor</b>				
B1201	147-0027-00	B010100	B049999	Motor, 48-40 Hz
B1201	147-0033-01	B050000		Motor, 48-62 Hz
<b>Capacitors</b>				
Tolerance $\pm 20\%$ unless otherwise indicated.				
C1	*285-0738-01			0.019 $\mu$ F MT 600 V 10%
C2	281-0550-00			120 pF Cer 500 V 10%
C4	281-0616-00			6.8 pF Cer 200 V
C5A	281-0174-00			0.8-10 pF, Var Tub. 500 V
C5B } C5D }	281-0173-00			15 pF/0.25-1.5 pF Mica 250 V 5%
C5C	281-0529-00			1.5 pF Cer 500 V $\pm 0.25$ pF
C5E	281-0618-00			4.7 pF Cer 200 V $\pm 0.5$ pF
C5G	281-0626-00			3.3 pF Cer 500 V 5%
C6A	281-0174-00			0.8-10 pF, Var Tub. 500 V
C6B } C6D }	281-0172-00			100 pF/0.25-1.5 pF Mica 250 V 5%
C6G	281-0612-00			5.6 pF Cer 200 V $\pm 0.5$ pF
C7	283-0649-00			105 pF Mica 300 V 1%
C25A	281-0616-00			6.8 pF Cer 200 V
C25C	283-0185-00			2.5 pF Cer 50 V 5%
C64 <sup>1</sup>	*388-0839-00			T coil
For Service Manuals Contact <b>MAURITRON TECHNICAL SERVICES</b> 8 Cherry Tree Rd, Garsington Oxon OX9 4QY Tel: 01844-351804 Fax: 01844-351554 Email: enquiries@mauritron.co.uk				
C101	*285-0738-01			0.019 $\mu$ F MT 600 V 10%
C102	281-0550-00			120 pF Cer 500 V 10%
C104	281-0616-00			6.8 pF Cer 200 V
C105A	281-0174-00			0.8-10 pF, Var Tub. 500 V
C105B } C105D }	281-0173-00			15 pF/0.25-1.5 pF Mica 250 V 5%
C105C	281-0529-00			1.5 pF Cer 500 V $\pm 0.25$ pF
C105E	281-0618-00			4.7 pF Cer 200 V $\pm 0.5$ pF
C105G	281-0626-00			3.3 pF Cer 500 V 5%
C106A	281-0174-00			0.8-10 pF, Var Tub. 500 V
C106B } C106D }	281-0172-00			100 pF/0.25-1.5 pF Mica 250 V 5%
C106G	281-0612-00			5.6 pF Cer 200 V $\pm 0.5$ pF
C107	283-0649-00			105 pF Mica 300 V 1%
C125A	281-0616-00			6.8 pF Cer 200 V
C125C	283-0185-00			2.5 pF Cer 50 V 5%
C125J	281-0616-00			6.8 pF Cer 200 V

<sup>1</sup>Furnished as a unit with L64.

## CHASSIS (cont)

Ckt. No.	Tektronix Part No.	Serial/Model No. Eff	Disc	Description		
<b>Capacitors (cont)</b>						
C164 <sup>2</sup>	*388-0839-00			T coil		
C238	290-0267-00			1 $\mu$ F	Elect.	35 V
C385	283-0303-00	XB140000		0.01 $\mu$ F	Cer	150 V
C394	281-0537-00			0.68 pF	Cer	500 V
C396	283-0092-00			0.03 $\mu$ F	Cer	200 V
C397	283-0092-00			0.03 $\mu$ F	Cer	200 V
						+80%—20%
						+80%—20%
						+80%—20%
C494	281-0537-00			0.68 pF	Cer	500 V
C495	281-0609-00			1 pF	Cer	200 V
C497	283-0092-00			0.03 $\mu$ F	Cer	200 V
C551 <sup>3</sup>	*388-0839-00			T coil		
C555 <sup>4</sup>	*388-0839-00			T coil		
						10%
						+80%—20%
C602	281-0617-00			15 pF	Cer	200 V
C604A	281-0503-00			8 pF	Cer	500 V
C604C	281-0627-00			1 pF	Cer	600 V
C606	283-0068-00			0.01 $\mu$ F	Cer	500 V
C607	281-0523-00			100 pF	Cer	350 V
						$\pm 0.5$ pF
C608	281-0504-00			10 pF	Cer	500 V
C609	281-0620-00			21 pF	Cer	500 V
C740A	281-0094-00			5.5-18 pF, Var	Cer	
C740B	283-0144-00			33 pF	Cer	500 V
C740C	281-0094-00			5.5-18 pF, Var	Cer	
C740D	283-0097-00			84 pF	Cer	1000 V
						10%
						1%
						1%
						1%
						2%
C740E <sup>5</sup>	*295-0089-00			0.001 $\mu$ F		
C740F				0.01 $\mu$ F		Checked assembly
C740G				0.1 $\mu$ F		
C740H	281-0523-00			100 pF	Cer	350 V
C740J <sup>5</sup>	*295-0089-00			1 $\mu$ F		Checked assembly
C740K	283-0032-00			470 pF	Cer	500 V
C740L	281-0523-00			100 pF	Cer	350 V
C740M <sup>5</sup>	*295 0089-00			10 $\mu$ F		Checked assembly
C740N	283-0144-00			33 pF	Cer	500 V
C740P	281-0094-00			5.5-18 pF, Var	Cer	
						5%
C760A	281-0519-00			47 pF	Cer	500 V
C760B	281-0525-00			470 pF	Cer	500 V
C760C	285-0699-00			0.0047 $\mu$ F	PTM	100 V
C760D	290-0282-00			0.047 $\mu$ F	Elect.	35 V
C760E	290-0283-00			0.47 $\mu$ F	Elect.	35 V
						10%
						10%
						10%
						10%

<sup>2</sup>Furnished as a unit with L164.<sup>3</sup>Furnished as a unit with L551.<sup>4</sup>Furnished as a unit with L555.<sup>5</sup>Individual timing capacitors in this assembly must be ordered by the 9 digit part number, letter suffix and tolerance printed on the timing capacitor to be replaced.

Example:

F—

285-XXXX-XX

The letter suffix and the tolerance should be the same for all of the timing capacitors in the assembly.

## CHASSIS (cont)

Kct. No.	Tektronix Part No.	Serial/Model No. Eff	Disc	Description
<b>Capacitors (cont)</b>				
C760F	290-0284-00			4.7 $\mu$ F
C766	283-0081-00			0.1 $\mu$ F
C783	281-0523-00			100 pF
C802	281-0617-00			15 pF
C804A	281-0503-00			8 pF
C804C	281-0627-00			1 pF
C806	283-0068-00			0.01 $\mu$ F
C807	281-0523-00			100 pF
C808	281-0504-00			10 pF
C809	281-0620-00			21 pF
C930A	281-0094-00			5.5-18 pF, Var
C930B	283-0144-00			33 pF
C930C	281-0094-00			5.5-18 pF, Var
C930D	283-0097-00			84 pF
C930E <sup>6</sup>	*295-0079-00			0.001 $\mu$ F
C930F				0.01 $\mu$ F
C930G				0.1 $\mu$ F
C930H		281-0523-00		
C930J <sup>6</sup>	*295-0079-00			1 $\mu$ F
For Service Manuals Contact <b>MAURIVION ELECTRONIC SERVICES</b> 8 Church Green Rd, Chinnor Oxon OX9 4QY Tel:- 01844-351694 Fax:- 01844-352554 Email:- enquiries@maurivion.co.uk				
C930N	283-0144-00			33 pF
C930P	281-0094-00			5.5-18 pF, Var
C1105	283-0080-00			0.022 $\mu$ F
C1111 <sup>7</sup>	*119-0221-00			0.02 $\mu$ F
C1112	290-0313-00			2800 $\mu$ F
C1128	290-0162-00			22 $\mu$ F
C1141 <sup>8</sup>	*119-0221-00			0.02 $\mu$ F
C1142	290-0313-00			2800 $\mu$ F
C1167	290-0162-00			22 $\mu$ F
C1171 <sup>9</sup>	*119-0221-00			0.02 $\mu$ F
C1172	290-0280-00			200 $\mu$ F
C1200	285-0686-00	B010100	B010278	0.5 $\mu$ F
C1200	285-0922-00	B010279		0.6 $\mu$ F
C1201	285-0566-00			0.022 $\mu$ F
C1202	290-0280-00			200 $\mu$ F
C1203	283-0008-00	XB120000		0.1 $\mu$ F
C1204	290-0314-00			10 $\mu$ F

<sup>6</sup>Individual timing capacitors in this assembly must be ordered by the 9 digit part number, letter suffix and tolerance printed on the timing capacitor to be replaced.

Example:

F—  
285-XXXX-XX

The letter suffix and the tolerance should be the same for all of the timing capacitors in the assembly.

<sup>7</sup>Furnished as a unit with R1111.

<sup>8</sup>Furnished as a unit with R1141.

<sup>9</sup>Furnished as a unit with R1171.

CHASSIS (cont)

Ckt. No.	Tektronix Part No.	Serial/Model No. Eff	Disc	Description
----------	--------------------	----------------------	------	-------------

Capacitors (cont)

C1211	285-0566-00			PTM 200 V 10%
C1403	290-0159-00			Elect. 150 V
C1408	283-0044-00			Cer 3000 V
C1437	290-0312-00			Elect. 35 V
C1440	283-0120-00			Cer 2500 V +80%—30%
C1449	283-0120-00			Cer 2500 V +80%—30%
C1452	283-0120-00			Cer 2500 V +80%—30%
C1453	283-0021-00			Cer 5000 V
C1455	281-0556-00			Cer 10,000 V
C1457	281-0556-00			Cer 10,000 V
C1460	283-0096-00			Cer 20,000 V
C1463	283-0057-00			Cer 200 V +80%—20%
C1469	283-0120-00			Cer 2500 V +80%—30%
C1472	283-0092-00			Cer 200 V +80%—20%
C1477	283-0120-00			Cer 2500 V +80%—30%
C1479	281-0525-00			Cer 500 V
C1489	283-0092-00			Cer 200 V +80%—20%

Semiconductor Device, Diodes

CR760	*152-0185-00			Silicon	Replaceable by 1N4152
CR761	*152-0185-00			Silicon	Replaceable by 1N4152
CR763	*152-0185-00			Silicon	Replaceable by 1N4152
CR1112A,B,C,D	152-0198-00			Silicon	Rectifier MR 1032A 200 V PIV
CR1142A,B,C,D	152-0198-00			Silicon	Rectifier MR 1032A 200 V PIV
CR1172A,B,C,D	152-0066-00			Silicon	1N3194
CR1202	152-0066-00			Silicon	1N3194
CR1212	152-0066-00			Silicon	1N3194
CR1404	*152-0185-00			Silicon	Replaceable by 1N4152
CR1440	152-0192-00	B010100	B099999	Silicon	Rectifier 7701-5 X Varo
CR1440	*152-0429-00	B100000		Silicon	Replaceable by VG-5X
CR1452	152-0192-00	B010100	B099999	Silicon	Rectifier 7701-5 X Varo
CR1452	*152-0429-00	B100000		Silicon	Replaceable by VG-5X
CR1453	152-0408-00			Silicon	Rectifier High voltage 10,000 V
CR1455	152-0408-00			Silicon	Rectifier High voltage 10,000 V
CR1457	152-0408-00			Silicon	Rectifier High voltage 10,000 V
VR766	152-0217-00			Zener	1N756A 400 mW, 8.2 V, 5%
VR1463	152-0428-00			Zener	1N987B 400 mV, 120 V, 5%

Bulbs

DS63	150-0035-00			Neon, A1D T2
DS163	150-0035-00			Neon, A1D T2
DS505	150-0035-00			Neon, A1D T2
DS506	150-0035-00			Neon, A1D T2
DS740W	150-0035-00			Neon, A1D T2



## CHASSIS (cont)

Ckt. No.	Tektronix Part No.	Serial/Model No. Eff	Disc	Description
----------	--------------------	----------------------	------	-------------

## Bulbs (cont)

DS792 <sup>10</sup>				
DS793	150-0046-00			Incandescent #21070
DS1029	150-0035-00			Neon, A1D T2
DS1107	150-0045-00			Incandescent #685
DS1108	150-0047-00			Incandescent #CN8-398
DS1109	150-0047-00			Incandescent #CN8-398
DS1473	150-0030-00			Neon NE 2 V GE
DS1474	150-0030-00			Neon NE 2 V GE
DS1475	150-0030-00			Neon NE 2 V GE

## Delay Line

DL285	*119-0242-00			Delay Line
-------	--------------	--	--	------------

## Fuses

F1101	159-0021-00	2 A	3AG	Fast-Blo
F1102	159-0022-00	1 A	3AG	Fast-Blo
F1204	159-0028-00	1/4 A	3AG	Fast-Blo
F1437	159-0021-00	2 A	3AG	Fast-Blo

## Connectors

J1	131-0955-00			Receptacle, electrical, female, BNC
J101	131-0955-00			Receptacle, electrical, female, BNC
J501	131-0955-00			Receptacle, electrical, female, BNC
J601	131-0955-00			Receptacle, electrical, female, BNC
J729	131-0955-00			Receptacle, electrical, female, BNC
J750	131-0955-00			Receptacle, electrical, female, BNC
J801	131-0955-00			Receptacle, electrical, female, BNC
J916	131-0955-00			Receptacle, electrical, female, BNC
J1238	131-0438-01			Receptacle, electrical, 3 contact, female
J1239	131-0438-01			Receptacle, electrical, 3 contact, female
J1299	131-0955-00			Receptacle, electrical, female, BNC
J1306	129-0064-00			Post, binding

For Service Manuals Contact  
**MAURIFRON TECHNICAL SERVICES**  
 8 Cherry Tree Rd, Chinnor  
 Oxon OX9 4QY  
 Tel: 01844-351634 Fax: 01844-352554  
 Email: enquiries@maurifron.co.uk

## Inductors

L64 <sup>11</sup>	*388-0839-00	T coil		
L164 <sup>12</sup>	*388-0839-00	T coil		
L295	*108-0262-00	0.6 $\mu$ H		
L394	*114-0232-00	0.13-0.22 $\mu$ H, Var	Core 276-0568-00	
L494	*114-0232-00	0.13-0.22 $\mu$ H, Var	Core 276-0568-00	

<sup>10</sup>Furnished as a unit with 5783.

<sup>11</sup>Furnished as a unit with C64.

<sup>12</sup>Furnished as a unit with C164.

## CHASSIS (cont)

Kct. No.	Tektronix Part No.	Serial/Model No. Eff	Disc	Description
<b>Inductors (cont)</b>				
L551 <sup>13</sup>	*388-0839-00			T coil
L555 <sup>14</sup>	*388-0839-00			T coil
L1238	*120-0398-00			Toroid, 15 turns, single
L1239	*120-0398-00			Toroid, 15 turns, single
L1437	*108-0422-00			80 $\mu$ H
L1480	*108-0321-00			Trace rotator
L1485	*108-0295-00			Y-Axis alignment
LR49B	*108-0621-00			66 $\mu$ H (wound on a 10 $\Omega$ , $\frac{1}{8}$ W, 5% resistor)
LR49F	*108-0621-00			66 $\mu$ H (wound on a 10 $\Omega$ , $\frac{1}{8}$ W, 5% resistor)
LR149B	*108-0621-00			66 $\mu$ H (wound on a 10 $\Omega$ , $\frac{1}{8}$ W, 5% resistor)
LR149F	*108-0621-00			66 $\mu$ H (wound on a 10 $\Omega$ , $\frac{1}{8}$ W, 5% resistor)

## Transistors

Q1133	*151-0136-00	Silicon	NPN	TO-5	Replaceable by 2N3053
Q1137	*151-0140-00	Silicon	NPN	TO-3	Selected from 2N3055
Q1163	*151-0136-00	Silicon	NPN	TO-5	Replaceable by 2N3053
Q1167	*151-0140-00	Silicon	NPN	TO-3	Selected from 2N3055
Q1197	151-0209-00	Silicon	NPN	TO-3	Selected from 2N3442
Q1430	151-0140-00	Silicon	NPN	TO-3	Selected from 2N3055

## Resistors

Resistors are fixed, composition,  $\pm 10\%$  unless otherwise indicated.

R2	307-0104-00	3.3 $\Omega$	$\frac{1}{4}$ W		5%
R3	315-0105-00	1 M $\Omega$	$\frac{1}{4}$ W		5%
R4	315-0101-00	100 $\Omega$	$\frac{1}{4}$ W		5%
R5B	322-0621-21	900 k $\Omega$	$\frac{1}{4}$ W	Prec	$\frac{1}{2}\%$
R5D	321-1389-01	111 k $\Omega$	$\frac{1}{8}$ W	Prec	$\frac{1}{2}\%$
R5E	315-0680-00	68 $\Omega$	$\frac{1}{4}$ W		5%
R5G	315-0910-00	91 $\Omega$	$\frac{1}{4}$ W		5%
R6A	315-0301-00	300 $\Omega$	$\frac{1}{4}$ W		5%
R6B	322-0624-01	990 k $\Omega$	$\frac{1}{4}$ W	Prec	$\frac{1}{2}\%$
R6D	321-1289-01	10.1 k $\Omega$	$\frac{1}{8}$ W	Prec	$\frac{1}{2}\%$
R6E	315-0750-00	75 $\Omega$	$\frac{1}{4}$ W		5%
R6G	315-0221-00	220 $\Omega$	$\frac{1}{4}$ W		5%

<sup>13</sup>Furnished as a unit with C551.

<sup>14</sup>Furnished as a unit with C555.

## CHASSIS (cont)

Kct. No.	Tektronix Part No.	Serial/Model No. Eff	Disc	Description		
<b>Resistors (cont)</b>						
R7	321-0756-03			50 k $\Omega$	1/8 W	Prec 1/4%
R21	311-1105-00			500 $\Omega$ , Var		
R25A	321-0910-02			307 $\Omega$	1/8 W	Prec 1/2%
R25C	321-0911-02			829 $\Omega$	1/8 W	Prec 1/2%
R25E	321-0612-02			500 $\Omega$	1/8 W	Prec 1/2%
R25J	321-0906-02			310 $\Omega$	1/8 W	Prec 1/2%
R35	311-0091-00			1 k $\Omega$ , Var		
R49B	321-1037-02			24 $\Omega$	1/8 W	Prec 1/2%
R49C	315-0112-00	XB110000		1.1 k $\Omega$		(nominal value) Selected
R49F	321-0907-02			98 $\Omega$	1/8 W	Prec 1/2%
R60A,B <sup>15</sup>	*311-0638-01			80 $\Omega$ x 1 k $\Omega$ , Var		
R63	315-0154-00			150 k $\Omega$	1/4 W	5%
R64	321-0114-00			150 $\Omega$	1/8 W	Prec 1%
R66	321-0064-00			45.3 $\Omega$	1/8 W	Prec 1%
R67	311-0169-00			100 $\Omega$ , Var		
R76	321-0064-00			45.3 $\Omega$	1/8 W	Prec 1%
R102	307-0104-00			3.3 $\Omega$	1/4 W	5%
R103	315-0105-00			1 M $\Omega$	1/4 W	5%
R104	315-0101-00			100 $\Omega$	1/4 W	5%
R105B	322-0621-21			900 k $\Omega$	1/4 W	Prec 1/2%
R105D	321-1389-01			111 k $\Omega$	1/8 W	Prec 1/2%
R105E	315-0680-00			68 $\Omega$	1/4 W	5%
R105G	315-0910-00			91 $\Omega$	1/4 W	5%
R106A	315-0301-00			300 $\Omega$	1/4 W	5%
R106B	322-0624-01			990 k $\Omega$	1/4 W	Prec 1/2%
R106D	321-1289-01			10.1 k $\Omega$	1/8 W	Prec 1/2%
R106E	315-0750-00			75 $\Omega$	1/4 W	5%
R106G	315-0221-00			220 $\Omega$	1/4 W	5%
R107	321-0756-03			50 k $\Omega$	1/8 W	Prec 1/4%
R112	316-0103-00			10 k $\Omega$	1/4 W	Prec 1/2%
R121	311-1105-00			500 $\Omega$ , Var		
R125A	321-0910-02			307 $\Omega$	1/8 W	Prec 1/2%
R125C	321-0911-02			829 $\Omega$	1/8 W	Prec 1/2%
R125E	321-0612-02			500 $\Omega$	1/8 W	Prec 1/2%
R125J	321-0906-02			310 $\Omega$	1/8 W	Prec 1/2%
R135	311-0091-00			1 k $\Omega$ , Var		
R149B	321-1037-02			24 $\Omega$	1/8 W	Prec 1/2%
R149C	315-0112-00	XB110000		1.1 k $\Omega$		(nominal value) Selected
R149F	321-0907-02			98 $\Omega$	1/8 W	
R160A,B <sup>16</sup>	*311-0638-01			80 $\Omega$ x 1 k $\Omega$ , Var		
R163	315-0154-00			150 k $\Omega$	1/4 W	5%
R164	321-0114-00			150 $\Omega$	1/8 W	Prec 1%
R166	321-0064-00			45.3 $\Omega$	1/8 W	Prec 1%
R167	311-0169-00			100 $\Omega$ , Var		
R176	321-0064-00			45.3 $\Omega$	1/8 W	Prec 1%
R232	315-0200-00			20 $\Omega$	1/4 W	5%
R295	315-0910-00			91 $\Omega$	1/4 W	5%

<sup>15</sup>Furnished as a unit with S60.<sup>16</sup>Furnished as a unit with S160.

## CHASSIS (cont)

Ckt. No.	Tektronix Part No.	Serial/Model No. Eff	Disc	Description			
<b>Resistors (cont)</b>							
R394	311-0609-00			2 k $\Omega$ , Var			
R396	306-0390-00			39 $\Omega$	2 W		
R397	308-0425-00			350 $\Omega$	8 W	WW	1%
R494	311-0609-00			2 k $\Omega$ , Var			
R495	315-0472-00			4.7 k $\Omega$	1/4 W		5%
R497	308-0425-00			350 $\Omega$	8 W	WW	1%
R503	321-0094-00			93.1 $\Omega$	1/8 W	Prec	1%
R505	316-0154-00			150 k $\Omega$	1/4 W		
R506	316-0154-00			150 k $\Omega$	1/4 W		
R567	311-0598-00			500 $\Omega$ , Var			
R601	315-0100-00			10 $\Omega$	1/4 W		5%
R604B	315-0914-00			910 k $\Omega$	1/4 W		5%
R604C	315-0114-00			110 k $\Omega$	1/4 W		5%
R607	315-0563-00			56 k $\Omega$	1/4 W		5%
R609	315-0104-00			100 k $\Omega$	1/4 W		5%
R610	315-0100-00			10 $\Omega$	1/4 W		5%
R649	311-0553-00			2 x 10 k $\Omega$ , Var			
R740A	323-0739-02	B010100	B099999	157.4 k $\Omega$	1/2 W	Prec	1/2%
R740A	323-0739-07	B100000		157.4 k $\Omega$	1/2 W	Prec	1/10%
R740B	323-0362-02			57.6 k $\Omega$	1/2 W	Prec	1/2%
R740C	323-0739-02	B010100	B099999	157.4 k $\Omega$	1/2 W	Prec	1/2%
R740C	323-0739-07	B100000		157.4 k $\Omega$	1/2 W	Prec	1/10%
R740E	323-0345-02			38.3 k $\Omega$	1/2 W	Prec	1/2%
R740G	325-0078-00			11.8 M $\Omega$	1 W	Prec	1%
R740H	325-0078-00			11.8 M $\Omega$	1 W	Prec	1%
R740J	325-0076-00			7.87 M $\Omega$	1 W	Prec	1%
R740K	325-0074-00			3.935 M $\Omega$	1 W	Prec	1%
R740M	325-0070-00	B010100	B099999	2.361 M $\Omega$	1 W	Prec	1/2%
R740M	323-0738-07	B100000		2.361 M $\Omega$	1/2 W	Prec	1/10%
R740P	323-0471-01	B010100	B099999	787 k $\Omega$	1/2 W	Prec	1/2%
R740P	323-0471-07	B100000		787 k $\Omega$	1/2 W	Prec	1/10%
R740R	323-0471-07			787 k $\Omega$	1/2 W	Prec	1/10%
R740S <sup>17</sup>	311-0554-00			20 k $\Omega$ , Var			
R740T	315-0272-00			2.7 k $\Omega$	1/4 W		5%
R740W	316-0154-00			150 k $\Omega$	1/4 W		
R741	301-0221-00			220 $\Omega$	1/2 W		5%
R742	316-0106-00			10 M $\Omega$	1/4 W		
R761	315-0102-00			1 k $\Omega$	1/4 W		5%
R762	311-0553-00			2 x 10 k $\Omega$ , Var			
R763	321-0372-00			73.2 k $\Omega$	1/8 W	Prec	1%
R765	311-0191-00			10 k $\Omega$ , Var			
R766	323-0347-00			40.2 k $\Omega$	1/2 W	Prec	1%
R801	315-0100-00			10 $\Omega$	1/4 W		5%

<sup>17</sup>Furnished as a unit with S7405.

## CHASSIS (cont)

Ckt. No.	Tektronix Part No.	Serial/Model No. Eff	Disc	Description		
<b>Resistors (cont)</b>						
R804B	315-0914-00		910 k $\Omega$	1/4 W		5%
R804C	315-0114-00		110 k $\Omega$	1/4 W		5%
R807	315-0563-00		56 k $\Omega$	1/4 W		5%
R809	315-0104-00		100 k $\Omega$	1/4 W		5%
R810	315-0100-00		10 $\Omega$	1/4 W		5%
R849	311-0555-00		10 k $\Omega$ , Var			
R930A	323-0739-02		157.4 k $\Omega$	1/2 W	Prec	1/2%
R930B	323-0362-02		57.6 k $\Omega$	1/2 W	Prec	1/2%
R930C	323-0739-02		157.4 k $\Omega$	1/2 W	Prec	1/2%
R930E	323-0345-02		38.3 k $\Omega$	1/2 W	Prec	1/2%
R930G	325-0078-00		11.8 M $\Omega$	1 W	Prec	1%
R930H	325-0078-00		11.8 M $\Omega$	1 W	Prec	1%
R930J	325-0076-00		7.87 M $\Omega$	1 W	Prec	1%
R930K	325-0074-00		3.935 M $\Omega$	1 W	Prec	1%
R930M	325-0070-00		2.361 M $\Omega$	1 W	Prec	1/2%
R930P	323-0471-01		787 k $\Omega$	1/2 W	Prec	1/2%
R930R	323-0471-07		787 k $\Omega$	1/2 W	Prec	1/10%
R930S <sup>18</sup>	311-0554-00		20 k $\Omega$ , Var			
R930T	315-0272-00		2.7 k $\Omega$	1/4 W		5%
R930U	315-0332-00		3.3 k $\Omega$	1/4 W		5%
R997	311-0386-00		2 k $\Omega$ , Var			
R1000A,B	311-0542-01		10 k $\Omega$ x 50 k $\Omega$ , Var			
R1029	316-0154-00		150 k $\Omega$	1/4 W		
R1104	316-0153-00		15 k $\Omega$	1/4 W		
R1105	316-0472-00		4.7 k $\Omega$	1/4 W		
R1106	315-0102-00		1 k $\Omega$	1/4 W		5%
R1107	316-0330-00		33 $\Omega$	1/4 W		
R1108	311-0548-00		25 $\Omega$ , Var			
R1111 <sup>19</sup>	*119-0221-00		10 $\Omega$			
R1112	316-0103-00		10 k $\Omega$	1/4 W		
R1137	315-0121-00		120 $\Omega$	1/4 W		5%
R1141 <sup>20</sup>	*119-0221-00		10 $\Omega$			
R1142	316-0103-00		10 k $\Omega$	1/4 W		
R1167	315-0121-00		120 $\Omega$	1/4 W		5%
R1171 <sup>21</sup>	*119-0221-00		10 $\Omega$			
R1172	316-0104-00		100 k $\Omega$	1/4 W		
R1197	308-0365-00		1.5 $\Omega$	3 W	WW	5%
R1202	316-0104-00		100 k $\Omega$	1/4 W		
R1204	302-0270-00		27 $\Omega$	1/2 W		
R1301	311-0511-00		10 k $\Omega$ , Var			
R1403	315-0204-00		200 k $\Omega$	1/4 W		5%

<sup>18</sup>Furnished as a unit with 5930S.<sup>19</sup>Furnished as a unit with C1111.<sup>20</sup>Furnished as a unit with C1141.<sup>21</sup>Furnished as a unit with C1171.

## CHASSIS (cont)

Ckt. No.	Tektronix Part No.	Serial/Model No. Eff	Disc	Description	
<b>Resistors (cont)</b>					
R1404	301-0105-00		1 M $\Omega$	1/2 W	5%
R1405	301-0305-00		3 M $\Omega$	1/2 W	5%
R1406	301-0305-00		3 M $\Omega$	1/2 W	5%
R1407	301-0305-00		3 M $\Omega$	1/2 W	5%
R1408	301-0305-00		3 M $\Omega$	1/2 W	5%
R1409	301-0305-00		3 M $\Omega$	1/2 W	5%
R1410	301-0305-00		3 M $\Omega$	1/2 W	5%
R1411	301-0305-00		3 M $\Omega$	1/2 W	5%
R1412	301-0305-00		3 M $\Omega$	1/2 W	5%
R1441	301-0103-00		10 k $\Omega$	1/2 W	5%
R1442	301-0106-00		10 M $\Omega$	1/2 W	5%
R1443	301-0106-00		10 M $\Omega$	1/2 W	5%
R1444	301-0106-00		10 M $\Omega$	1/2 W	5%
R1445	301-0106-00		10 M $\Omega$	1/2 W	5%
R1446	301-0106-00		10 M $\Omega$	1/2 W	5%
R1447	311-0657-00		2 M $\Omega$ , Var		
R1448	301-0206-00		20 M $\Omega$	1/2 W	5%
R1449	316-0105-00		1 M $\Omega$	1/4 W	
R1450	308-0588-00		12 $\Omega$	1/2 W	WW 1%
R1458	301-0103-00		10 k $\Omega$	1/2 W	5%
R1460	316-0105-00		1 M $\Omega$	1/4 W	
R1461	316-0105-00		1 M $\Omega$	1/4 W	
R1463	301-0205-00		2 M $\Omega$	1/2 W	5%
R1464	301-0335-00		3.3 M $\Omega$	1/2 W	5%
R1465	301-0335-00		3.3 M $\Omega$	1/2 W	5%
R1466	301-0335-00		3.3 M $\Omega$	1/2 W	5%
R1467	311-0254-00		5 M $\Omega$ , Var		
R1468	301-0106-00		10 M $\Omega$	1/2 W	5%
R1469	301-0155-00		1.5 M $\Omega$	1/2 W	5%
R1471	301-0183-00		18 k $\Omega$	1/2 W	5%
R1472	301-0223-00	B010100	B010469	22 k $\Omega$	1/2 W 5%
R1472	301-0273-00	B010470		27 k $\Omega$	1/2 W 5%
R1476	301-0103-00			10 k $\Omega$	1/2 W 5%
R1477	316-0470-00			47 $\Omega$	1/4 W
R1479	315-0221-00			220 $\Omega$	1/4 W 5%
R1480	311-0458-00			5 k $\Omega$ , Var	
R1485	311-0458-00			5 k $\Omega$ , Var	
R1488	315-0103-00			10 k $\Omega$	1/4 W 5%
R1489	311-0329-00			50 k $\Omega$ , Var	

## CHASSIS (cont)

Ckt. No.	Tektronix Part No.	Serial/Model No. Eff	Disc	Description
<b>Switches</b>				
	Wired or Unwired			
S1	260-1168-00			Lever CH 1 COUPLING
S5	*644-0022-00			Rotary CH 1 VOLTS/DIV
S5	260-1190-00			Rotary CH 1 VOLTS/DIV
S60 <sup>22</sup>				CH 1 CAL
S101	260-1168-00			Lever CH 2 COUPLING
S105	*644-0022-00			Rotary CH 2 VOLTS/DIV
S105	260-1190-00			Rotary CH 2 VOLTS/DIV
S160 <sup>23</sup>				CH 2 CAL
S238A	260-1147-00			Rotary MODE
S345	260-1143-00			Lever BANDWIDTH-BEAM FINDER
S602	260-1148-00			Lever A SOURCE
S608	260-1150-00			Lever A COUPLING
S650	260-0472-00			Lever A SLOPE
S740S <sup>24</sup>				A CAL
S750A,B	*262-0909-00	B010100	B099999	Rotary A,B TIME/DIV
S750A,B	*262-0909-02	B100000		Rotary A,B TIME/DIV
S750A,B	260-1152-00			Rotary A,B TIME/DIV
S765	*262-0910-00			Rotary A SWEEP LENGTH
S765	260-0825-00			Rotary A SWEEP LENGTH
S780	260-1149-00			Lever A SWEEP MODE
S783 <sup>25</sup>	260-0717-00			Push A RESET
S802	260-1148-00			Lever B SOURCE
S808	260-1150-00			Lever B COUPLING
S835	260-0587-00			Lever B SWEEP MODE
S850	260-0472-00			Lever B SLOPE
S930S <sup>26</sup>				B CAL
S1001A	260-1153-00			Rotary HORIZ DISPLAY
S1001B				
S1101	260-0834-00			Toggle MAG POWER
S1102 <sup>27</sup>				
S1103 <sup>27</sup>				
<b>Thermal Cut-Out</b>				
TK1100	260-0879-00			Thermostatic Open 191°F Close 161°F
<b>Transformers</b>				
T1101	*120-0649-00			LV Power
T1430	*120-0471-00			HV Power
<b>Electron Tube</b>				
V1479	*154-0619-00	B010100	B010469	CRT Standard Phosphor
V1479	*154-0619-05	B010470	B019999	CRT Standard Phosphor
V1479	*154-0619-10	B020000		CRT Standard Phosphor
<b>Optional Phosphors</b>				
	*154-0619-07			P2
	*154-0619-08			P7
	*154-0619-09			P11

<sup>22</sup>Furnished as a unit with R60A,B.<sup>23</sup>Furnished as a unit with R160A,B.<sup>24</sup>Furnished as a unit with R740S.<sup>25</sup>Furnished as a unit with D5792.<sup>26</sup>Furnished as a unit with R930S.<sup>27</sup>See Mechanical Parts List. Line Voltage Selector Body.

For Service Manuals Contact  
**MAURITRONICS**  
 8 Cherry Tree Ct, Chinnor  
 Oxon OX9 3EY  
 Tel: 01244-651631 Fax: 01244-655654  
 Email: enquiries@maurtronics.co.uk

**A1 VERTICAL PREAMP Circuit Board Assembly**

Ckt. No.	Tektronix Part No.	Serial/Model No. Eff	Disc	Description
	*670-0943-00	B010100	B039999	Complete Board
	*670-0943-02	B040000	B059999	Complete Board
	*670-0943-04	B060000	B069999	Complete Board
	*670-0943-01	B070000		Complete Board

**Capacitors**

Tolerance  $\pm 20\%$  unless otherwise indicated.

C9	281-0064-00			0.25-1.5 pF, Var	Plastic		
C10	281-0614-00			6800 pF	Cer	500 V	+80%—20%
C13	283-0111-00			0.1 $\mu$ F	Cer	50 V	
C16	281-0122-00			2.5-9 pF, Var	Cer		
C18	281-0651-00			47 pF	Cer		5%
C22	281-0064-00			0.25-1.5 pF, Var	Plastic		
C23	283-0080-00			0.022 $\mu$ F	Cer	25 V	+80%—20%
C25E	281-0122-00			2.5-9 pF, Var	Cer	100 V	
C25J	281-0616-00			6.8 pF	Cer	200 V	
C29	281-0599-00	B010100	B059999	1 pF	Cer	200 V	$\pm 0.25$ pF
C29	281-0537-00	B060000		0.68 pF	Cer	500 V	
C33	281-0610-00			2.2 pF	(nominal value)		Selected
C37	283-0000-00			0.001 $\mu$ F	Cer	500 V	
C44	283-0111-00			0.1 $\mu$ F	Cer	50 V	
C45	281-0123-00			5-25 pF, Var	Cer	100 V	
C49A	283-0639-00			56 pF	Mica	100 V	1%
C49G	281-0123-00			5-25 pF, Var	Cer	100 V	
C49H	281-0123-00	B010100	B069999	5-25 pF, Var	Cer	100 V	
C49H	281-0122-00	B070000		2.5-9 pF, Var	Cer	100 V	
C50	281-0616-00	B010100	B010469	6.8 pF	Cer	200 V	
C50	281-0618-00	B010470		4.7 pF	Cer	200 V	$\pm 0.5$ pF
C56	281-0709-00			7 pF	Cer	500 V	+0.1 pF
C78	281-0122-00			2.5-9 pF, Var	Cer	100 V	
C80	281-0638-00			240 pF	Cer	500 V	5%
C81	283-0003-00			0.01 $\mu$ F	Cer	150 V	
C82	281-0599-00	B010100	B079999	1 pF	Cer	200 V	$\pm 0.25$ pF
C82	281-0599-00	B080000		1 pF	(nominal value)	Selected	
C86	283-0080-00			0.022 $\mu$ F	Cer	25 V	+80%—20%
C90	281-0123-00			5-25 pF, Var	Cer	100 V	
C91	283-0003-00			0.01 $\mu$ F	Cer	150 V	
C109	281-0064-00			0.25-1.5 pF, Var	Plastic		
C110	281-0614-00			6800 pF	Cer	500 V	+80%—20%
C113	283-0111-00			0.1 $\mu$ F	Cer	50 V	
C116	281-0122-00			2.5-9 pF, Var	Cer	100 V	
C118	281-0651-00			47 pF	Cer		5%
C122	281-0064-00			0.25-1.5 pF, Var	Plastic		
C123	283-0191-00			0.022 $\mu$ F	Cer	50 V	
C125E	281-0122-00			2.5-9 pF, Var	Cer	100 V	
C125J	281-0616-00			6.8 pF	Cer	200 V	
C129	281-0599-00	B010100	B059999	1 pF	Cer	200 V	$\pm 0.25$ pF



## A1 VERTICAL PREAMP Circuit Board Assembly (cont)

Ckt. No.	Tektronix Part No.	Serial/Model No. Eff	Disc	Description
<b>Capacitors (cont)</b>				
C129	281-0537-00	B060000	0.68 pF	Cer 500 V
C133	281-0610-00		2.2 pF	(nominal value) Selected
C137	283-0000-00		0.001 $\mu$ F	Cer 500 V
C144	283-0111-00		0.1 $\mu$ F	Cer 50 V
C145	281-0123-00		5-25 pF, Var	Cer 100 V
C149A	283-0639-00		56 pF	Mica 100 V 1%
C149G	281-0123-00		5-25 pF, Var	Cer 100 V
C149H	281-0123-00	B010100	5-25 pF, Var	Cer 100 V
C149H	281-0122-00	B070000	2.5-9 pF, Var	Cer 100 V
C150	281-0616-00		6.8 pF	Cer 200 V
C178	281-0122-00		2.5-9 pF, Var	Cer 100 V
C180	281-0501-00		4.7 pF	Cer 500 V $\pm 1$ pF
C181	283-0003-00		0.01 $\mu$ F	Cer 150 V
C186	283-0080-00		0.022 $\mu$ F	Cer 25 V +80%—20%
C190	281-0123-00		5-25 pF, Var	Cer 100 V
C191	283-0003-00		0.01 $\mu$ F	Cer 150 V
C215	281-0524-00		150 pF	Cer 500 V
C218	285-0699-00		0.0047 $\mu$ F	Elect. 100 V 10%
C225	281-0524-00		150 pF	Cer 500 V
C241	281-0549-00		68 pF	Cer 500 V 10%
C253	283-0081-00		0.1 $\mu$ F	Cer 25 V +80%—20%
C278	281-0617-00		15 pF	Cer 200 V
C288	281-0617-00		15 pF	Cer 200 V
C290	290-0267-00		1 $\mu$ F	Elect. 35 V
C294	281-0602-00		68 pF	Cer 500 V 5%
C1221	283-0092-00	For Service Manuals Contact MAURITRON ELECTRONICS 8 Cherry Tree Way, Linnor Oxley, OXFORD Tel: 01844-351634 Fax: 01844-350554 Email: enquiries@mauritron.co.uk	0.03 $\mu$ F	Cer 200 V +80%—20%
C1222	290-0135-00		15 $\mu$ F	Elect. 20 V
C1223	290-0267-00		1 $\mu$ F	Elect. 35 V
C1224	283-0059-00		1 $\mu$ F	Cer 25 V +80%—20%
C1225	290-0267-00		1 $\mu$ F	Elect. 35 V
C1226	290-0135-00		15 $\mu$ F	Elect. 20 V
C1227	283-0080-00		0.022 $\mu$ F	Cer 25 V +80%—20%
C1228	283-0081-00		0.1 $\mu$ F	Cer 25 V +80%—20%
C1229	283-0080-00		0.022 $\mu$ F	Cer 25 V +80%—20%
C1230	283-0191-00		0.022 $\mu$ F	Cer 50 V
C1235	283-0081-00		0.1 $\mu$ F	Cer 25 V +80%—20%
<b>Semiconductor Device, Diodes</b>				
CR13	*152-0323-00		Silicon	Tek Spec
CR36	*152-0185-00		Silicon	Replaceable by 1N4152
CR113	*152-0323-00		Silicon	Tek Spec
CR136	*152-0185-00		Silicon	Replaceable by 1N4152
CR201	*152-0153-00		Silicon	Tek Spec
CR202	*152-0153-00		Silicon	Tek Spec
CR203	*152-0153-00		Silicon	Tek Spec
CR204	*152-0153-00		Silicon	Tek Spec
CR206	*152-0153-00		Silicon	Tek Spec
CR207	*152-0153-00		Silicon	Tek Spec

## A1 VERTICAL PREAMP Circuit Board Assembly (cont)

Ckt. No.	Tektronix Part No.	Serial/Model No. Eff	Disc	Description
<b>Semiconductor Device, Diodes (cont)</b>				
CR208	*152-0153-00			Silicon Tek Spec
CR209	*152-0153-00			Silicon Tek Spec
CR212	*152-0185-00			Silicon Replaceable by 1N4152
CR218	152-0141-02			Silicon 1N4152
CR222	*152-0185-00			Silicon Replaceable by 1N4152
CR228	152-0141-02			Silicon 1N4152
CR234	*152-0185-00			Silicon Replaceable by 1N4152
CR274	*152-0185-00			Silicon Replaceable by 1N4152
VR13	152-0278-00			Zener 1N4372A 400 mW, 3 V, 5%
VR15	152-0278-00			Zener 1N4372A 400 mW, 3 V, 5%
VR113	152-0278-00			Zener 1N4372A 400 mW, 3 V, 5%
VR115	152-0278-00			Zener 1N4372A 400 mW, 3 V, 5%

## Inductors

L13	*108-0440-00			8 $\mu$ H
L22	*108-0182-00			0.3 $\mu$ H
L23	276-0507-00			Core, ferramic suppressor
L37	276-0507-00			Core, ferramic suppressor
L38	276-0507-00			Core, ferramic suppressor
L44	*108-0373-00			56 nH
L54	276-0528-00			Core, ferramic suppressor
L78	*108-0367-00	B010100	B010469	1 $\mu$ H
L78	*108-0215-00	B010470		1.1 $\mu$ H
L81	276-0528-00			Core, ferramic suppressor
L90	*108-0655-00			75 nH
L91	276-0528-00			Core, ferramic suppressor
L113	*108-0440-00			8 $\mu$ H
L122	*108-0182-00			0.3 $\mu$ H
L123	276-0507-00			Core, ferramic suppressor
L137	276-0507-00			Core, ferramic suppressor
L138	276-0507-00			Core, ferramic suppressor
L144	*108-0373-00			56 nH
L181	276-0528-00			Core, ferramic suppressor
L190	*108-0655-00			75 nH
L191	276-0528-00			Core, ferramic suppressor
L201	276-0528-00			Core, ferramic suppressor
L202	276-0528-00			Core, ferramic suppressor
L203	276-0528-00			Core, ferramic suppressor
L204	276-0528-00			Core, ferramic suppressor
L206	276-0528-00			Core, ferramic suppressor
L207	276-0528-00			Core, ferramic suppressor
L208	276-0528-00			Core, ferramic suppressor
L209	276-0528-00			Core, ferramic suppressor
L215	276-0507-00			Core, ferramic suppressor
L225	276-0507-00			Core, ferramic suppressor
L293	*108-0181-01	XB040000		0.2 $\mu$ H
L1223	*108-0440-00			8 $\mu$ H

## A1 VERTICAL PREAMP Circuit Board Assembly (cont)

Ckt. No.	Tektronix Part No.	Serial/Model No. Eff	Disc	Description	
<b>Inductors (cont)</b>					
L1225	*108-0440-00			8 $\mu$ H	
L1227	*108-0440-00			8 $\mu$ H	
L1229	*108-0440-00			8 $\mu$ H	
L1230	*108-0440-00			8 $\mu$ H	
<b>Transistors</b>					
Q13A,B	151-1032-00			Silicon	FET TO-5 Dual
Q16A,B } Q34 } Q38 } Q44 }	*153-0590-00			Silicon	Matched set
	*151-0190-01			Silicon	NPN TO-106 Tek Spec
	*151-0271-00			Silicon	PNP TO-18 Tek Spec
Q45	*151-0219-00			Silicon	PNP TO-18 Replaceable by 2N4250
Q54	*151-0269-00			Silicon	NPN TO-106 Selected from SE3005
Q56	*151-0269-00			Silicon	NPN TO-106 Selected from SE3005
Q64	*151-0212-00			Silicon	NPN TO-18 Tek Spec
Q74	*151-0212-00			Silicon	NPN TO-18 Tek Spec
Q84	*151-0271-00			Silicon	PNP TO-18 Tek Spec
Q94	*151-0271-00			Silicon	PNP TO-18 Tek Spec
Q113A,B } Q116A,B } Q134 }	151-1032-00			Silicon	FET TO-5 Dual
	*153-0590-00			Silicon	Matched set
Q138	151-0190-01			Silicon	NPN TO-106 Tek Spec
Q144	*151-0271-00			Silicon	PNP TO-18 Tek Spec
Q145	*151-0219-00			Silicon	PNP TO-18 Replaceable by 2N4250
Q164	*151-0212-00			Silicon	NPN TO-18 Tek Spec
Q174	*151-0212-00			Silicon	NPN TO-18 Tek Spec
Q184	*151-0271-00			Silicon	PNP TO-18 Tek Spec
Q194	*151-0271-00			Silicon	PNP TO-18 Tek Spec
Q215	*151-0190-01	B010100	B109999	Silicon	NPN TO-106 Tek Spec
Q215	151-0302-00	B110000	B129999	Silicon	NPN TO-18 2N2222A
Q215	*151-0190-01	B130000		Silicon	NPN TO-106 Tek Spec
Q225	*151-0190-01	B010100	B109999	Silicon	NPN TO-106 Tek Spec
Q225	151-0302-00	B110000	B129999	Silicon	NPN TO-18 2N2222A
Q225	*151-0190-01	B130000		Silicon	NPN TO-106 Tek Spec
Q234	151-0223-00			Silicon	NPN TO-18 2N4275
Q244	151-0223-00			Silicon	NPN TO-18 2N4275
Q253	151-0220-00			Silicon	PNP TO-18 2N4122
Q274	*151-0222-00			Silicon	NPN TO-46 Selected from 2N4251
Q284	*151-0222-00			Silicon	NPN TO-46 Selected from 2N4251
Q293	*151-0230-00	B010100	B039999	Silicon	NPN TO-105 Selected from RCA 40235
Q293	*151-0269-00	B040000		Silicon	NPN TO-106 Selected from SE3005

For Service Manuals Contact  
**MAURITRON TECHNOLOGIES LTD**  
 8 Cherry Tree Rd, Chinnor  
 Oxon OX9 4QY  
 Tel: 01294 351004 Fax: 01294 351054  
 Email: enquiries@mauritron.co.uk

**A1 VERTICAL PREAMP Circuit Board Assembly (cont)**

Ckt. No.	Tektronix Part No.	Serial/Model No. Eff	Disc	Description		
<b>Resistors</b>						
Resistors are fixed, composition, $\pm 10\%$ unless otherwise indicated.						
R8	315-0821-00			820 $\Omega$	1/4 W	5%
R9	323-0612-03			950 k $\Omega$	1/2 W	Prec 1/4%
R10	315-0125-00			1.2 M $\Omega$	1/4 W	5%
R13	315-0151-00			150 $\Omega$	1/4 W	5%
R15	315-0151-00			150 $\Omega$	1/4 W	5%
R16	311-0634-00			500 $\Omega$ , Var		
R17	315-0152-00			1.5 k $\Omega$	1/4 W	5%
R18	325-0041-00			19.75 $\Omega$	1/20 W	Prec 1%
R19	315-0152-00			1.5 k $\Omega$	1/4 W	5%
R20	315-0273-00			27 k $\Omega$	1/4 W	5%
R22	321-0915-07			1.219 k $\Omega$	1/8 W	Prec 1/10%
R24	325-0041-00			19.75 $\Omega$	1/20 W	Prec 1%
R26	315-0222-00			2.2 k $\Omega$	1/4 W	5%
R27	321-0267-00			5.9 k $\Omega$	1/8 W	Prec 1%
R28	311-0978-00			250 $\Omega$ , Var		
R29	317-0431-00			430 $\Omega$	(nominal value) Selected	
R30	321-0125-00			196 $\Omega$	1/8 W	Prec 1%
R31	321-0125-00			196 $\Omega$	1/8 W	Prec 1%
R32	321-0267-00			5.9 k $\Omega$	1/8 W	Prec 1%
R33	311-0634-00			500 $\Omega$ , Var		
R34	321-0222-00			2 k $\Omega$	1/8 W	Prec 1%
R36	321-0222-00			2 k $\Omega$	1/8 W	Prec 1%
R38	321-0184-00			806 $\Omega$	1/8 W	Prec 1%
R39	315-0752-00			7.5 k $\Omega$	1/4 W	5%
R40	311-0607-00			10 k $\Omega$ , Var		
R41	321-0203-00			1.27 k $\Omega$	1/8 W	Prec 1%
R42	321-0114-07			150 $\Omega$	1/8 W	Prec 1/10%
R43	315-0182-00			1.8 k $\Omega$	1/4 W	5%
R44	311-0622-00			100 $\Omega$ , Var		
R45	315-0431-00			430 $\Omega$	1/4 W	5%
R46	315-0621-00			620 $\Omega$	1/4 W	5%
R47	321-0143-07			301 $\Omega$	1/8 W	Prec 1/10%
R48	301-0122-00			1.2 k $\Omega$	1/2 W	5%
R49A	311-0622-00			100 $\Omega$ , Var		
R49G	311-0622-00			100 $\Omega$ , Var		
R49H	311-0635-00			1 k $\Omega$ , Var		
R50	315-0153-00	B010100	B010469	15 k $\Omega$	1/4 W	5%
R50	315-0203-00	B010470		20 k $\Omega$	1/4 W	5%
R52	311-0607-00			10 k $\Omega$ , Var		
R53	315-0103-00			10 k $\Omega$	1/4 W	5%
R54	321-0206-00			1.37 k $\Omega$	1/8 W	Prec 1%

## A1 VERTICAL PREAMP Circuit Board Assembly (cont)

Ckt. No.	Tektronix Part No.	Serial/Model No. Eff	Disc	Description		
<b>Resistors (cont)</b>						
R55	321-0201-00		1.21 k $\Omega$	1/8 W	Prec	1%
R56	321-0076-00		60.4 $\Omega$	1/8 W	Prec	1%
R57	321-0201-00		1.21 k $\Omega$	1/8 W	Prec	1%
R62	321-0083-00		71.5 $\Omega$	1/8 W	Prec	1%
R68	315-0620-00		62 $\Omega$	1/4 W		5%
R69	321-0066-00		47.5 $\Omega$	1/8 W	Prec	1%
R77	323-0167-00		536 $\Omega$	1/2 W	Prec	1%
R75	311-0643-00		50 $\Omega$ , Var			
R78	315-0620-00		62 $\Omega$	1/4 W		5%
R79	321-0066-00		47.5 $\Omega$	1/8 W	Prec	1%
R80	315-0680-00		68 $\Omega$	1/4 W		5%
R81	317-0151-00		150 $\Omega$	1/8 W		5%
R82	317-0560-00		56 $\Omega$	1/8 W		5%
R83	322-0156-00		412 $\Omega$	1/4 W	Prec	1%
R85	307-0106-00		4.7 $\Omega$	1/4 W		5%
R86	321-0186-00		845 $\Omega$	1/8 W	Prec	1%
R90	311-0605-00		200 $\Omega$ , Var			
R91	317-0151-00		150 $\Omega$	1/8 W		5%
R92	317-0560-00		56 $\Omega$	1/8 W		5%
R93	322-0156-00		412 $\Omega$	1/4 W	Prec	1%
R96	321-0154-00		392 $\Omega$	1/8 W	Prec	1%
R108	315-0821-00		820 $\Omega$	1/4 W		5%
R109	323-0512-03		950 k $\Omega$	1/2 W	Prec	1/4%
R110	315-0125-00		1.2 M $\Omega$	1/4 W		5%
R113	315-0151-00		150 $\Omega$	1/4 W		5%
R115	315-0151-00		150 $\Omega$	1/4 W		5%
R116	311-0634-00		500 $\Omega$ , Var			
R117	315-0152-00		1.5 k $\Omega$	1/4 W		5%
R118	325-0041-00		19.75 $\Omega$	1/20 W	Prec	1%
R119	315-0152-00		1.5 k $\Omega$	1/4 W		5%
R120	315-0273-00		27 k $\Omega$	1/4 W		5%
R122	321-0915-07		1.219 k $\Omega$	1/8 W	Prec	1/10%
R124	325-0041-00		19.75 $\Omega$	1/20 W	Prec	1%
R126	315-0222-00		2.2 k $\Omega$	1/4 W		5%
R127	321-0267-00		5.9 k $\Omega$	1/8 W	Prec	1%
R128	311-0978-00		250 $\Omega$ , Var			
R129	317-0431-00		430 $\Omega$ (nominal value) Selected			
R130	321-0125-00		196 $\Omega$	1/8 W	Prec	1%
R131	321-0125-00		196 $\Omega$	1/8 W	Prec	1%
R132	321-0267-00		5.9 k $\Omega$	1/8 W	Prec	1%
R133	311-0634-00		500 $\Omega$ , Var			
R134	321-0222-00		2 k $\Omega$	1/8 W	Prec	1%
R136	321-0222-00		2 k $\Omega$	1/8 W	Prec	1%
R138	321-0184-00		806 $\Omega$	1/8 W	Prec	1%
R139	315-0752-00		7.5 k $\Omega$	1/4 W		5%

For Service Manuals Contact  
**MAURITRON TECHNICAL SERVICES**  
 8 Cherry Tree Rd, Chinnor  
 Oxon OX9 4QY  
 Tel: 01844-351694 Fax: 01844-351554  
 Email: enquiries@maurifon.co.uk

## A1 VERTICAL PREAMP Circuit Board Assembly (cont)

Ckt. No.	Part No. Tektronix	Serial/Model No. Eff Disc	Description			
<b>Resistors (cont)</b>						
R140	311-0607-00		10 k $\Omega$ , Var			
R141	321-0203-00		1.27 k $\Omega$	1/8 W	Prec	1%
R142	321-0114-07		150 $\Omega$	1/8 W	Prec	1/10%
R143	315-0182-00		1.8 k $\Omega$	1/4 W		5%
R144	311-0622-00		100 $\Omega$ , Var			
R145	315-0431-00		430 $\Omega$	1/4 W		5%
R146	315-0621-00		620 $\Omega$	1/4 W		5%
R147	321-0143-07		301 $\Omega$	1/8 W	Prec	1/10%
R148	301-0122-00		1.2 k $\Omega$	1/2 W		5%
R149A	311-0622-00		100 $\Omega$ , Var			
R149G	311-0622-00		100 $\Omega$ , Var			
R149H	311-0635-00		1 k $\Omega$ , Var			
R150	315-0153-00		15 k $\Omega$	1/4 W		5%
R162	321-0083-00		71.5 $\Omega$	1/8 W	Prec	1%
R169	321-0066-00		47.5 $\Omega$	1/8 W	Prec	1%
R177	323-0167-00		536 $\Omega$	1/2 W	Prec	1%
R175	311-0643-00		50 $\Omega$ , Var			
R179	321-0066-00		47.5 $\Omega$	1/8 W	Prec	1%
R180	315-0121-00		120 $\Omega$	1/4 W		5%
R181	317-0151-00		150 $\Omega$	1/8 W		5%
R182	317-0560-00		56 $\Omega$	1/8 W		5%
R183	322-0156-00		412 $\Omega$	1/4 W	Prec	1%
R185	307-0106-00		4.7 $\Omega$	1/4 W		5%
R186	321-0186-00		845 $\Omega$	1/8 W	Prec	1%
R190	311-0605-00		200 $\Omega$ , Var			
R191	317-0151-00		150 $\Omega$	1/8 W		5%
R192	317-0560-00		56 $\Omega$	1/8 W		5%
R193	322-0156-00		412 $\Omega$	1/4 W	Prec	1%
R196	321-0154-00		392 $\Omega$	1/8 W	Prec	1%
R207	322-0180-00		732 $\Omega$	1/4 W	Prec	1%
R208	322-0180-00		732 $\Omega$	1/4 W	Prec	1%
R210	321-0136-00		255 $\Omega$	1/8 W	Prec	1%
R212	321-0127-00		205 $\Omega$	1/8 W	Prec	1%
R213	315-0200-00		20 $\Omega$	1/4 W		5%
R214	322-0123-00		187 $\Omega$	1/4 W	Prec	1%
R215	321-0234-00		2.67 k $\Omega$	1/8 W	Prec	1%
R216	321-0229-00		2.37 k $\Omega$	1/8 W	Prec	1%
R217	315-0183-00		18 k $\Omega$	1/4 W		5%
R219	321-0125-00		196 $\Omega$	1/8 W	Prec	1%
R220	321-0136-00		255 $\Omega$	1/8 W	Prec	1%
R222	321-0127-00		205 $\Omega$	1/8 W	Prec	1%
R223	315-0200-00		20 $\Omega$	1/4 W		5%
R224	322-0123-00		187 $\Omega$	1/4 W	Prec	1%
R225	321-0234-00		2.67 k $\Omega$	1/8 W	Prec	1%
R226	321-0229-00		2.37 k $\Omega$	1/8 W	Prec	1%

## A1 VERTICAL PREAMP Circuit Board Assembly (cont)

Ckt. No.	Part No. Tektronix	Serial/Model No. Eff	Disc	Description		
<b>Resistors (cont)</b>						
R229	321-0125-00		196 $\Omega$	1/8 W	Prec	1%
R233	321-0081-00		68.1 $\Omega$	1/8 W	Prec	1%
R234	315-0102-00		1 k $\Omega$	1/4 W		5%
R236	315-0153-00		15 k $\Omega$	1/4 W		5%
R241	315-0563-00		56 k $\Omega$	1/4 W		5%
R244	315-0472-00		4.7 k $\Omega$	1/4 W		5%
R245	315-0332-00		3.3 k $\Omega$	1/4 W		5%
R253	315-0301-00		300 $\Omega$	1/4 W		5%
R255	315-0221-00		220 $\Omega$	1/4 W		5%
R270	321-0199-00		1.15 k $\Omega$	1/8 W	Prec	1%
R271	321-0219-00		1.87 k $\Omega$	1/8 W	Prec	1%
R272	311-0978-00		250 $\Omega$ , Var			
R274	321-0150-00		357 $\Omega$	1/8 W	Prec	1%
R276	321-0118-00		165 $\Omega$	1/8 W	Prec	1%
R278	321-0065-00		46.4 $\Omega$	1/8 W	Prec	1%
R279	323-0148-00		340 $\Omega$	1/2 W	Prec	1%
R280	321-0199-00		1.15 k $\Omega$	1/8 W	Prec	1%
R284	321-0230-00		2.43 k $\Omega$	1/8 W	Prec	1%
R286	321-0118-00		165 $\Omega$	1/8 W	Prec	1%
R288	321-0065-00		46.4 $\Omega$	1/8 W	Prec	1%
R289	323-0148-00		340 $\Omega$	1/2 W	Prec	1%
R290	316-0100-00		10 $\Omega$	1/4 W		
R292	315-0820-00	B010100	82 $\Omega$	1/4 W		5%
R293	315-0122-00		1.2 k $\Omega$	1/4 W		5%
R294	315-0390-00		39 $\Omega$	1/4 W		5%
R501	321-0081-00		68.1 $\Omega$	1/8 W	Prec	1%
R502	321-0068-00		49.9 $\Omega$	1/8 W	Prec	1%
R1222	316-0100-00		10 $\Omega$	1/4 W		
R1224	315-0101-00		100 $\Omega$	1/4 W		5%
R1228	315-0100-00		10 $\Omega$	1/4 W		5%
R1235	315-0100-00		10 $\Omega$	1/4 W		5%

For Service Manuals Contact  
MAURITRON TECHNOLOGIES  
8 Cherry Tree Rd, Chalfont  
Oxon OX9 4QY  
Tel: 01844-351894 Fax: 01844-350554  
Email: enquiries@mauriton.co.uk

## Switch

Wired or Unwired

S181	260-0723-00	Slide	INVERT
------	-------------	-------	--------

## Transformer

T240	*120-0384-00	Toroid, 2 windings
------	--------------	--------------------

**A2 VERTICAL OUTPUT Circuit Board Assembly**

Ckt. No.	Tektronix Part No.	Serial/Model No. Eff	Disc	Description
	*670-0939-00	B010100	B029999	Complete Board
	*670-0939-01	B030000		Complete Board

**Capacitors**

Tolerance  $\pm 20\%$  unless otherwise indicated.

C307	281-0577-00			14 pF	Cer	500 V	5%
C317	283-0204-00			0.01 $\mu$ F	Cer	50 V	
C326	281-0617-00	XB030000		15 pF	Cer	200 V	
C330	283-0156-00			1000 pF	Cer	200 V	+100%—0%
C335	283-0095-00			56 pF	Cer	200 V	10%
C337 <sup>28</sup>	*388-0867-00	B010100	B010779	T coil, 4T			
C337 <sup>28</sup>	*388-0867-01	B010780	B029999	T coil, 4T			
C337	281-0609-00	B030000		1 pF (Added if necessary)			
C341	283-0204-00			0.01 $\mu$ F	Cer	50 V	
C352	281-0617-00			15 pF	Cer	200 V	
C353	281-0123-00			5-25 pF, Var	Cer	100 V	
C355	283-0156-00			1000 pF	Cer	200 V	+100%—0%
C407	281-0577-00			14 pF	Cer	500 V	5%
C417	283-0204-00			0.01 $\mu$ F	Cer	50 V	
C424	283-0201-00			27 pF	Cer	200 V	10%
C425	281-0627-00	XB030000		1 pF (nominal value)	Selected		
C426	281-0122-00			2.5-9 pF, Var	Cer	100 V	
C430	283-0156-00			1000 pF	Cer	200 V	+100%—0%
C435	281-0621-00			12 pF	Cer	500 V	1%
C437 <sup>29</sup>	*388-0867-00	B010100	B010779	T coil, 4T			
C437 <sup>29</sup>	*388-0867-01	B010780	B029999	T coil, 4T			
C437	281-0609-00	B030000		1 pF (Added if necessary)			
C442	283-0204-00			0.01 $\mu$ F	Cer	50 V	
C455	283-0156-00			1000 pF	Cer	200 V	+100%—0%
C1232	283-0204-00			0.01 $\mu$ F	Cer	50 V	
C1234	283-0204-00			0.01 $\mu$ F	Cer	50 V	

**Semiconductor Device, Diodes**

CR323	*152-0185-00			Silicon	Replaceable by 1N4152
CR324	*152-0185-00			Silicon	Replaceable by 1N4152
CR325	*152-0185-00			Silicon	Replaceable by 1N4152
CR423	*152-0185-00	XB030000		Silicon	Replaceable by 1N4152
CR424	*152-0185-00			Silicon	Replaceable by 1N4152
VR339	152-0166-00			Zener	1N753A 400 mW, 6.2 V, 5%
VR388	152-0278-00			Zener	1N4372A 400 mW, 3 V, 5%

**Relay**

K442	*148-0044-00			Armature, sens, DPDT
------	--------------	--	--	----------------------

<sup>28</sup>Furnished as a unit with L337.

<sup>29</sup>Furnished as a unit with L437.



## A2 VERTICAL OUTPUT Circuit Board Assembly (cont)

Ckt. No.	Tektronix Part No.	Serial/Model No. Eff	Disc	Description
<b>Inductors</b>				
L308	*108-0262-00			0.6 $\mu$ H
L318	*108-0170-01			0.5 $\mu$ H
L333	276-0569-00			Core, toroid ferrite
L334 <sup>30</sup>				
L335	*108-0262-00			0.6 $\mu$ H
L337 <sup>31</sup>	*388-0867-00	B010100	B010779	T coil, 4T
L337 <sup>31</sup>	*388-0867-01	B010789	B029999	T coil, 4T
L337	*108-0675-00	B030000		124 nH
L343	*108-0440-00			8 $\mu$ H
L418	*108-0170-01			0.5 $\mu$ H
L434 <sup>30</sup>				
L435	*108-0262-00			0.6 $\mu$ H
L437 <sup>32</sup>	*388-0867-00	B010100	B010780	T coil, 4T
L437 <sup>32</sup>	*388-0867-01	B010780	B029999	T coil, 4T
L437	*108-0675-00	B030000		124 nH
L1234	*108-0440-00			8 $\mu$ H
LR318	*108-0430-00			0.88 $\mu$ H (wound on a 68 $\Omega$ , 1/4 W, 5% resistor)
LR319	*108-0445-00			0.6 $\mu$ H (wound on a 91 $\Omega$ , 1/4 W, 5% resistor)
LR418	*108-0429-00			1.2 $\mu$ H (wound on a 47 $\Omega$ , 1/4 W, 5% resistor)
LR419	*108-0428-00			4.2 $\mu$ H (wound on a 33 $\Omega$ , 1/2 W, 5% resistor)

For Service Manuals Contact  
MAURITRON TECHNOLOGIES  
8 Cherry Tree Rd, Chinnor  
Oxon OX9 4QY  
Tel: 01844-351224 Fax: 01844-350554  
Email: enquiries@mauritron.co.uk

## Transistors

Q314	*151-0222-00	Silicon	NPN	TO-46	Selected from 2N4251
Q324	*151-0271-00	Silicon	PNP	TO-18	Tek Spec
Q334	151-0221-00	Silicon	PNP	TO-18	2N4258
Q354	*151-0222-00	Silicon	NPN	TO-46	Selected from 2N4251
Q364	*151-0193-00	Silicon	NPN	TO-18	Tek Spec
Q388	151-0220-00	Silicon	PNP	TO-18	2N4122
Q414	*151-0222-00	Silicon	NPN	TO-46	Selected from 2N4251
Q424	*151-0271-00	Silicon	PNP	TO-18	Tek Spec
Q434	151-0221-00	Silicon	PNP	TO-18	2N4258
Q454	*151-0222-00	Silicon	NPN	TO-46	Selected from 2N4251
Q464	*151-0193-00	Silicon	NPN	TO-18	Tek Spec

## Resistors

Resistors are fixed, composition,  $\pm 10\%$  unless otherwise indicated.

R307	321-0064-00	45.3 $\Omega$	1/8 W	Prec	1%
R308	317-0101-00	100 $\Omega$	1/8 W		5%
R311	315-0222-00	2.2 k $\Omega$	1/4 W		5%
R312	315-0181-00	180 $\Omega$	1/4 W		5%
R316	315-0181-00	180 $\Omega$	1/4 W		5%

<sup>30</sup>Part of Circuit Board.

<sup>31</sup>Furnished as a unit with C337.

<sup>32</sup>Furnished as a unit with C437.

## A2 VERTICAL OUTPUT Circuit Board Assembly (cont)

Ckt. No.	Tektronix Part No.	Serial/Model No. Eff Disc	Description
Resistors (cont)			
R317	317-0390-00		39 $\Omega$ $\frac{1}{8}$ W 5%
R318	321-0121-00		178 $\Omega$ (nominal value) Selected $\frac{1}{8}$ W 5%
R321	321-0105-00		121 $\Omega$ $\frac{1}{8}$ W Prec 1%
R323	321-0105-00		121 $\Omega$ $\frac{1}{8}$ W Prec 1%
R324	321-0075-00		59 $\Omega$ $\frac{1}{8}$ W Prec 1%
R325	315-0123-00		12 k $\Omega$ $\frac{1}{4}$ W 5%
R326	315-0123-00	XB030000	12 k $\Omega$ $\frac{1}{4}$ W 5%
R330	317-0330-00		33 $\Omega$ $\frac{1}{8}$ W 5%
R331	317-0431-00		430 $\Omega$ $\frac{1}{8}$ W 5%
R332	317-0242-00		2.4 k $\Omega$ $\frac{1}{8}$ W 5%
R333	317-0151-00		150 $\Omega$ $\frac{1}{8}$ W 5%
R334	311-0644-00		20 k $\Omega$ , Var $\frac{1}{8}$ W Prec 1%
R338	321-0094-00		93.1 $\Omega$ $\frac{1}{8}$ W Prec 1%
R339	301-0221-00		220 $\Omega$ $\frac{1}{2}$ W 5%
R340	315-0751-00		750 $\Omega$ $\frac{1}{4}$ W 5%
R341	322-0114-00		150 $\Omega$ $\frac{1}{4}$ W Prec 1%
R346	321-0055-00		36.5 $\Omega$ $\frac{1}{8}$ W Prec 1%
R347	321-0055-00		36.5 $\Omega$ $\frac{1}{8}$ W Prec 1%
R353	311-0605-00		200 $\Omega$ , Var $\frac{1}{8}$ W 5%
R355	317-0470-00		47 $\Omega$ $\frac{1}{8}$ W 5%
R356	317-0221-00		220 $\Omega$ $\frac{1}{8}$ W 5%
R357	317-0221-00		220 $\Omega$ $\frac{1}{8}$ W 5%
R362	315-0181-00		180 $\Omega$ $\frac{1}{4}$ W 5%
R381	301-0103-00		10 k $\Omega$ $\frac{1}{2}$ W 5%
R382	311-0634-00		500 $\Omega$ , Var $\frac{1}{4}$ W 5%
R383	315-0122-00		1.2 k $\Omega$ $\frac{1}{4}$ W 5%
R384	315-0152-00		1.5 k $\Omega$ $\frac{1}{4}$ W 5%
R385	301-0912-00		9.1 k $\Omega$ $\frac{1}{2}$ W 5%
R407	321-0064-00		45.3 $\Omega$ $\frac{1}{8}$ W Prec 1%
R415	317-0390-00		39 $\Omega$ $\frac{1}{8}$ W 5%
R416	315-0181-00		180 $\Omega$ $\frac{1}{4}$ W 5%
R417	311-0633-00		5 k $\Omega$ , Var $\frac{1}{8}$ W Prec 1%
R418	321-0120-00		174 $\Omega$ $\frac{1}{8}$ W Prec 1%
R419	311-0634-00		500 $\Omega$ , Var $\frac{1}{8}$ W Prec 1%
R421	321-0105-00		121 $\Omega$ $\frac{1}{8}$ W Prec 1%
R423	321-0105-00		121 $\Omega$ $\frac{1}{8}$ W Prec 1%
RT424	308-0244-00		1 k $\Omega$ Thermal
R426	311-0635-00		1 k $\Omega$ , Var
R430	317-0330-00		33 $\Omega$ $\frac{1}{8}$ W 5%
R431	317-0431-00		430 $\Omega$ $\frac{1}{8}$ W 5%
R432	317-0242-00		2.4 k $\Omega$ $\frac{1}{8}$ W 5%

**A2 VERTICAL OUTPUT Circuit Board Assembly (cont)**

Ckt. No.	Tektronix Part No.	Serial/Model No. Eff	Disc	Description
<b>Resistors (cont)</b>				
R434	315-0221-00		220 $\Omega$	1/4 W 5%
R438	321-0094-00		93.1 $\Omega$	1/8 W Prec 1%
R446	321-0055-00		36.5 $\Omega$	1/8 W Prec 1%
R447	321-0055-00		36.5 $\Omega$	1/8 W Prec 1%
R455	317-0470-00		47 $\Omega$	1/8 W 5%
R456	317-0221-00		220 $\Omega$	1/8 W 5%
R457	317-0221-00		220 $\Omega$	1/8 W 5%

**Transformer**

T358	*120-0469-00			Toroid, 3 turns, bifilar
------	--------------	--	--	--------------------------

**A3 THICK FILM HYBRID Circuit Board Assembly**

\*155-0040-00

Complete Board

**Capacitors**Tolerance  $\pm 20\%$  unless otherwise indicated.

C368<sup>33</sup>  
 C369<sup>33</sup>  
 C375<sup>33</sup>  
 C468<sup>33</sup>  
 C475<sup>33</sup>

For Service Manuals Contact  
 MAURITON TECHNOLOGIES LTD  
 8 Cherry Tree Rd, Oxford  
 Oxon OX9 4QY  
 Tel: 01844-351694 Fax: 01844-351554  
 Email: enquiries@mauriton.co.uk

**Semiconductor Device, Diodes**

VR363	152-0195-00	Zener	1N751A	400 mV, 5.1 V, 5%
VR463	152-0195-00	Zener	1N751A	400 mV, 5.1 V, 5%

**Inductors**

L368	*108-0616-00		89 nH
L369	*108-0440-00		Toroid, 4 turns
L385	*108-0440-00		Toroid, 4 turns
L468	*108-0616-00		89 nH

\*Furnished as a unit with \*155-0040-00.

**A3 THICK FILM HYBRID Circuit Board Assembly (cont)**

Ckt. No.	Tektronix Part No.	Serial/Model No. Eff	No. Disc	Description
<b>Transistors</b>				
Q374	151-0213-00			Silicon
Q394	*151-0211-00			NPN TO-18 Tek Spec
Q474	151-0213-00			Silicon NPN TO-5 Selected from 2N3866
Q494	*151-0211-00			Silicon NPN TO-18 Tek Spec
				NPN TO-5 Selected from 2N3866

**Resistors**

Resistors are fixed, composition,  $\pm 10\%$  unless otherwise indicated.

R364 <sup>34</sup>						
R365	311-0633-00			5 k $\Omega$ , Var		
R368 <sup>34</sup>						
R371 <sup>34</sup>						
R375 <sup>34</sup>						
R391	307-0107-00			5.6 $\Omega$	1/4 W	5%
R464 <sup>34</sup>						
R468 <sup>34</sup>						
R471 <sup>34</sup>						
R472 <sup>34</sup>						
R475 <sup>34</sup>						
R491	307-0107-00			5.6 $\Omega$	1/4 W	5%

**A4 A SWEEP Circuit Board Assembly**

*670-0941-00	B010100	B010499	Complete Board
*670-0941-01	B010500	B010599	Complete Board
*670-0941-02	B010600	B039999	Complete Board
*670-0941-04	B040000	B079999	Complete Board
*670-0941-03	B080000		Complete Board

**Capacitors**

Tolerance  $\pm 20\%$  unless otherwise indicated.

C508	281-0504-00	10 pF	Cer	500 V	10%
C512	290-0267-00	1 $\mu$ F	Elect.	35 V	
C513	290-0267-00	1 $\mu$ F	Elect.	35 V	
C519	290-0267-00	1 $\mu$ F	Elect.	35 V	
C521	281-0506-00	12 pF	Cer	500 V	10%
C533	281-0511-00	22 pF	Cer	500 V	10%
C539	290-0267-00	1 $\mu$ F	Elect.	35 V	
C540	283-0111-00	0.1 $\mu$ F	Cer	50 V	
C543	281-0511-00	22 pF	Cer	500 V	10%
C614	281-0571-00	82 pF	Cer	500 V	

\*Furnished as a unit with \*155-0040-00.

## A4 A SWEEP Circuit Board Assembly (cont)

Ckt. No.	Tektronix Part No.	Serial/Model No. Eff	Disc	Description
Capacitors (cont)				
C617	283-0068-00		0.01 $\mu$ F	Cer 500 V
C623	283-0111-00		0.1 $\mu$ F	Cer 50 V
C626	281-0523-00		100 pF	Cer 350 V
C645	283-0080-00		0.022 $\mu$ F	Cer 25 V +80%—20%
C651	283-0080-00		0.022 $\mu$ F	Cer 25 V +80%—20%
C652	283-0080-00		0.022 $\mu$ F	Cer 25 V +80%—20%
C659	283-0080-00		0.022 $\mu$ F	Cer 25 V +80%—20%
C662	283-0111-00		0.1 $\mu$ F	Cer 50 V
C664	283-0000-00		0.001 $\mu$ F	Cer 500 V
C666	281-0617-00		15 pF	Cer 200 V
C668	283-0000-00		0.001 $\mu$ F	Cer 500 V
C671	281-0602-00		68 pF	Cer 500 V
C672	283-0080-00		0.022 $\mu$ F	Cer 25 V +80%—20%
C674	283-0000-00		0.001 $\mu$ F	Cer 500 V
C676	283-0111-00		0.1 $\mu$ F	Cer 50 V
C684	283-0178-00		0.1 $\mu$ F	Cer 100 V +80%—20%
C685	281-0617-00	XB040000	15 pF	Cer 200 V
C689	290-0246-00		3.3 $\mu$ F	Elect. 15 V 10%
C692	290-0267-00		1 $\mu$ F	Elect. 35 V
C702	281-0525-00		470 pF	Cer 500 V
C713	283-0080-00		0.022 $\mu$ F	Cer 25 V +80%—20%
C714	290-0267-00		1 $\mu$ F	Elect. 35 V
C721	283-0111-00		0.1 $\mu$ F	Cer 50 V
C725	283-0177-00		1 $\mu$ F	Cer 25 V +80%—20%
C728	281-0513-00		27 pF	Cer 500 V
C731	283-0080-00		0.022 $\mu$ F	Cer 25 V +80%—20%
C735	281-0558-00		18 pF	Cer 500 V
C739	283-0000-00		0.001 $\mu$ F	Cer 500 V
C744	283-0111-00		0.1 $\mu$ F	Cer 50 V
C757	281-0523-00		100 pF	Cer 350 V
C758	290-0135-00		15 $\mu$ F	Elect. 20 V
C759	281-0523-00		100 pF	Cer 350 V
C774	283-0080-00		0.022 $\mu$ F	Cer 25 V +80%—20%
C775	281-0622-00		47 pF	Cer 500 V 1%
C778	283-0080-00		0.022 $\mu$ F	Cer 25 V +80%—20%
C784	290-0134-00		22 $\mu$ F	Elect. 15 V
C785	281-0523-00	B010100	100 pF	Cer 350 V
C787	283-0119-00		2200 pF	Cer 200 V 5%
C793	283-0081-00	XB010600	0.1 $\mu$ F	Cer 25 V +80%—20%
C1246	290-0135-00		15 $\mu$ F	Elect. 20 V
C1248	290-0135-00		15 $\mu$ F	Elect. 20 V
C1249	283-0178-00		0.1 $\mu$ F	Cer 100 V +80%—20%
C1252	290-0267-00		1 $\mu$ F	Elect. 35 V
C1254	290-0267-00		1 $\mu$ F	Elect. 35 V
C1255	290-0267-00		1 $\mu$ F	Elect. 35 V

**A4 A SWEEP Circuit Board Assembly (cont)**

Kct. No.	Tektronix Part No.	Serial/Model No. Eff	Disc	Description
<b>Semiconductor Device, Diodes</b>				
CR516	*152-0153-00		Silicon	Tek Spec
CR623	*152-0323-00		Silicon	Tek Spec
CR636	*152-0185-00		Silicon	Replaceable by 1N4152
CR638	*152-0185-00		Silicon	Replaceable by 1N4152
CR651	*152-0185-00		Silicon	Replaceable by 1N4152
CR652	*152-0185-00		Silicon	Replaceable by 1N4152
CR654	*152-0153-00		Silicon	Tek Spec
CR655	*152-0153-00		Silicon	Tek Spec
CR657	152-0310-00		Tunnel	5 mA
CR671	*152-0322-00		Silicon	Tek Spec
CR681	*152-0153-00		Silicon	Tek Spec
CR687	*152-0185-00		Silicon	Replaceable by 1N4152
CR692	*152-0185-00		Silicon	Replaceable by 1N4152
CR701	*152-0153-00		Silicon	Tek Spec
CR702	152-0310-00		Tunnel	5 mA
CR709	*152-0153-00	For Service Manuals Contact MAURITON TECHNOLOGIES 8 Cherry Tree Rd, Chinnor Oxon OX9 4QY Tel: 01844-851694 Fax: 01844-850554 Email: enquiries@mauriton.co.uk	Silicon	Tek Spec
CR710	*152-0185-00		Silicon	Replaceable by 1N4152
CR715	*152-0153-00		Silicon	Tek Spec
CR717	*152-0153-00		Silicon	Tek Spec
CR721	*152-0185-00		Silicon	Replaceable by 1N4152
CR726	*152-0185-00		Silicon	Replaceable by 1N4152
CR728	*152-0185-00		Silicon	Replaceable by 1N4152
CR732	*152-0185-00		Silicon	Replaceable by 1N4152
CR735	*152-0185-00		Silicon	Replaceable by 1N4152
CR739	*152-0185-00	XB010600	Silicon	Replaceable by 1N4152
CR749	*152-0185-00		Silicon	Replaceable by 1N4152
CR750	*152-0185-00		Silicon	Replaceable by 1N4152
CR757	152-0151-00		Silicon	Assembly of 1N4152
CR759	*152-0185-00		Silicon	Replaceable by 1N4152
CR769	*152-0185-00		Silicon	Replaceable by 1N4152
CR770	*152-0185-00		Silicon	Replaceable by 1N4152
CR772	*152-0185-00		Silicon	Replaceable by 1N4152
CR773	*152-0185-00		Silicon	Replaceable by 1N4152
CR793	*152-0185-00		Silicon	Replaceable by 1N4152
CR794	*152-0153-00		Silicon	Tek Spec
CR795	*152-0153-00		Silicon	Tek Spec
CR796	*152-0153-00		Silicon	Tek Spec
CR797	*152-0153-00		Silicon	Tek Spec
VR521	152-0166-00		Zener	1N753A 400 mW, 6.2 V, 5%
VR543	152-0166-00		Zener	1N753A 400 mW, 6.2 V, 5%
VR641	152-0278-00		Zener	1N4372A 400 mW, 3 V, 5%
VR642	152-0278-00		Zener	1N4372A 400 mW, 3 V, 5%
VR1249	152-0149-00		Zener	1N961B 0.4 mW, 10 V, 5%

## A4 A SWEEP Circuit Board Assembly (cont)

Ckt. No.	Tektronix Part No.	Serial/Model No. Eff	Disc	Description
<b>Inductors</b>				
L543	*108-0262-00			0.6 $\mu$ H
L636	276-0507-00			Core, ferramic suppressor
L638	276-0507-00			Core, ferramic suppressor
L651	276-0507-00			Core, ferramic suppressor
L652	276-0507-00			Core, ferramic suppressor
L656	*108-0620-00			90 nH
L664	*108-0619-00			90 nH
L687	276-0507-00			Core, ferramic suppressor
L735	276-0507-00			Core, ferramic suppressor
L759	276-0507-00			Core, ferramic suppressor
L1246	*108-0440-00			8 $\mu$ H
L1248	*108-0440-00			8 $\mu$ H
L1255	*120-0382-00			Toroid, 14 turns, single
LR695	*108-0491-00			25 $\mu$ H (wound on a 180 $\Omega$ , 1/2 W, 5% resistor)
<b>Transistors</b>				
Q514	*151-0212-00		Silicon	NPN TO-18 Tek Spec
Q524	*151-0271-00		Silicon	PNP TO-18 Tek Spec
Q534	*151-0271-00		Silicon	PNP TO-18 Tek Spec
Q544	*151-0222-00		Silicon	NPN TO-46 Selected from 2N4251
Q623	151-1025-00		Silicon	FET N channel, junction type TO-18 X55
Q624	*151-0259-00		Silicon	NPN TO-106 Selected from 2N3563
Q636	*151-0259-00		Silicon	NPN TO-106 Selected from 2N3563
Q646	*151-0259-00		Silicon	NPN TO-106 Selected from 2N3563
Q664	*151-0271-00		Silicon	PNP TO-18 Tek Spec
Q669	151-0221-00		Silicon	PNP TO-18 2N4258
Q674	*151-0212-00		Silicon	NPN TO-18 Tek Spec
Q685	151-0223-00		Silicon	NPN TO-18 2N4275
Q694	151-0220-00		Silicon	PNP TO-18 2N4122
Q695	151-0223-00		Silicon	NPN TO-18 2N4275
Q704	151-0131-00		Germanium	PNP TO-18 2N964
Q714	151-0224-00		Silicon	NPN TO-18 2N3692
Q716	151-0223-00		Silicon	NPN TO-18 2N4275
Q724	*151-0283-00		Silicon	NPN TO-72 Tek Spec
Q726	151-0224-00		Silicon	NPN TO-18 2N3692
Q727	151-0223-00		Silicon	NPN TO-18 2N4275
Q733	151-1025-00		Silicon	FET N channel, junction type TO-18 X55
Q734	*151-0127-00		Silicon	NPN TO-18 Selected from 2N2369
Q737	151-0220-00		Silicon	PNP TO-18 2N4122
Q744	*151-0133-00		Silicon	PNP TO-18 Tek Spec
Q753	*151-0261-00		Silicon	PNP TO-78 Dual, Tek Spec

**A4 A SWEEP Circuit Board Assembly (cont)**

Ckt. No.	Tektronix Part No.	Serial/Model No. Eff	Disc		Description
<b>Transistors (cont)</b>					
Q754	*151-0133-00			Silicon	PNP TO-18 Tek Spec
Q764	151-0224-00			Silicon	NPN TO-18 2N3692
Q774	*151-0133-00	B010100	B010469	Silicon	NPN TO-18 Tek Spec
Q774	151-0188-00	B010470		Silicon	PNP TO-92 2N3906
Q775	*151-0133-00	B010100	B010469	Silicon	PNP TO-18 Tek Spec
Q775	151-0188-00	B010470		Silicon	PNP TO-92 2N3906
Q784	151-0223-00			Silicon	NPN TO-18 2N4275
Q785	151-0220-00			Silicon	NPN TO-18 2N4122
Q786	151-0223-00	B010100	B079999	Silicon	NPN TO-18 2N4275
Q786	151-0302-00	B080000		Silicon	NPN TO-18 2N2222A
Q794	*151-0136-00			Silicon	NPN TO-5 Replaceable by 2N3053
<b>Resistors</b>					
Resistors are fixed, composition, ±10% unless otherwise indicated.					
R508	315-0101-00			100 Ω	1/4 W 5%
R509	321-0094-00			93.1 Ω	1/8 W Prec 1%
R510	321-0179-00			715 Ω	1/8 W Prec 1%
R511	311-0634-00			500 Ω, Var	
R512	317-0220-00			22 Ω	1/8 W 5%
R513	315-0470-00			47 Ω	1/4 W 5%
R514	321-0213-00			1.62 kΩ	1/8 W Prec 1%
R515	321-0114-00			150 Ω	1/8 W Prec 1%
R516	321-0180-00			732 Ω	1/8 W Prec 1%
R517	315-0470-00			47 Ω	1/4 W 5%
R518	321-0154-00			392 Ω	1/8 W Prec 1%
R519	315-0100-00			10 Ω	1/4 W 5%
R521	315-0101-00			100 Ω	1/4 W 5%
R525	321-0197-00			1.1 kΩ	1/8 W Prec 1%
R530	315-0470-00			47 Ω	1/4 W 5%
R531	321-0212-00			1.58 kΩ	1/8 W Prec 1%
R532	321-0139-00			274 Ω	1/8 W Prec 1%
R533	315-0470-00			47 Ω	1/4 W 5%
R534	321-0190-00			931 Ω	1/8 W Prec 1%
R536	321-0175-00			649 Ω	1/8 W Prec 1%
R538	315-0470-00			47 Ω	1/4 W 5%
R539	307-0106-00			4.7 Ω	1/4 W 5%
R543	317-0620-00			62 Ω	1/8 W 5%
R544	315-0220-00			22 Ω	1/4 W 5%
R614	321-0356-00			49.9 kΩ	1/8 W Prec 1%
R615	323-0612-00			950 kΩ	1/2 W Prec 1%
R617	315-0105-00			1 MΩ	1/4 W 5%
R623	315-0270-00			27 Ω	1/4 W 5%
R624	315-0151-00			150 Ω	1/4 W 5%
R625	315-0272-00			2.7 kΩ	1/4 W 5%
R626	315-0471-00			470 Ω	1/4 W 5%



## A4 A SWEEP Circuit Board Assembly (cont)

Ckt. No.	Tektronix Part No.	Serial/Model No. Eff	Disc	Description	
<b>Resistors (cont)</b>					
R628	315-0182-00			1.8 k $\Omega$	1/4 W 5%
R637	315-0162-00			1.6 k $\Omega$	1/4 W 5%
R641	315-0362-00			3.6 k $\Omega$	1/4 W 5%
R642	315-0133-00			13 k $\Omega$	1/4 W 5%
R643	311-0510-00	B010100	B1129999	10 k $\Omega$ , Var	
R643	311-1228-00	B130000		10 k $\Omega$ , Var	
R644	315-0272-00			2.7 k $\Omega$	1/4 W 5%
R645	315-0270-00			27 $\Omega$	1/4 W 5%
R646	315-0391-00			390 $\Omega$	1/4 W 5%
R648	315-0122-00			1.2 k $\Omega$	1/4 W 5%
R651	315-0101-00			100 $\Omega$	1/4 W 5%
R652	315-0101-00			100 $\Omega$	1/4 W 5%
R656	315-0181-00			180 $\Omega$	1/4 W 5%
R657	315-0472-00			4.7 k $\Omega$	1/4 W 5%
R658	315-0431-00			430 $\Omega$	1/4 W 5%
R659	315-0100-00			10 $\Omega$	1/4 W 5%
R664	301-0153-00			15 k $\Omega$	1/2 W 5%
R666	317-0560-00			56 $\Omega$	1/8 W 5%
R667	315-0821-00			820 $\Omega$	1/4 W 5%
R668	315-0391-00			390 $\Omega$	1/4 W 5%
R669	315-0391-00			390 $\Omega$	1/4 W 5%
R670	315-0201-00			200 $\Omega$	1/4 W 5%
R671	315-0103-00			10 k $\Omega$	1/4 W 5%
R673	315-0220-00			22 $\Omega$	1/4 W 5%
R674	315-0152-00			1.5 k $\Omega$	1/4 W 5%
R676	315-0510-00			51 $\Omega$	1/4 W 5%
R680	315-0101-00			100 $\Omega$	1/4 W 5%
R681	315-0273-00			27 k $\Omega$	1/4 W 5%
R684	315-0101-00			100 $\Omega$	1/4 W 5%
R685	315-0104-00			100 k $\Omega$	1/4 W 5%
R690	315-0104-00			100 k $\Omega$	1/4 W 5%
R692	315-0470-00			47 $\Omega$	1/4 W 5%
R694	315-0272-00			2.7 k $\Omega$	1/4 W 5%
R696	315-0910-00			91 $\Omega$	1/4 W 5%
R697	315-0332-00			3.3 k $\Omega$	1/4 W 5%
R699	315-0102-00			1 k $\Omega$	1/4 W 5%
R701	315-0101-00			100 $\Omega$	1/4 W 5%
R702	315-0330-00			33 $\Omega$	1/4 W 5%
R704	321-0176-00			665 $\Omega$	1/8 W Prec 1%
R705	315-0752-00			7.5 k $\Omega$	1/4 W 5%
R707	315-0472-00			4.7 k $\Omega$	1/4 W 5%

## A4 A SWEEP Circuit Board Assembly (cont)

Ckt. No.	Tektronix Part No.	Serial/Model No. Eff Disc	Description
<b>Resistors (cont)</b>			
R710	315-0202-00	2 k $\Omega$	1/4 W 5%
R712	321-0164-00	499 $\Omega$	1/8 W Prec 1%
R713	321-0269-00	6.19 k $\Omega$	1/8 W Prec 1%
R714	315-0330-00	33 $\Omega$	1/4 W 5%
R715	315-0101-00	100 $\Omega$	1/4 W 5%
R716	322-0151-00	365 $\Omega$	1/4 W Prec 1%
R717	321-0257-00	4.64 k $\Omega$	1/8 W Prec 1%
R718	315-0562-00	5.6 k $\Omega$	1/4 W 5%
R719	315-0823-00	82 k $\Omega$	1/4 W 5%
R720	321-0175-00	649 $\Omega$	1/8 W Prec 1%
R721	321-0203-00	1.27 k $\Omega$	1/8 W Prec 1%
R722	315-0101-00	100 $\Omega$	1/4 W 5%
R723	315-0470-00	47 $\Omega$	1/4 W 5%
R724	301-0681-00	680 $\Omega$	1/2 W 5%
R725	315-0100-00	10 $\Omega$	1/4 W 5%
R726	315-0122-00	1.2 k $\Omega$	1/4 W 5%
R727	315-0331-00	330 $\Omega$	1/4 W 5%
R728	315-0332-00	3.3 k $\Omega$	1/4 W 5%
R729	315-0331-00	330 $\Omega$	1/4 W 5%
R730	315-0101-00	100 $\Omega$	1/4 W 5%
R731	315-0470-00	47 $\Omega$	1/4 W 5%
R732	315-0470-00	47 $\Omega$	1/4 W 5%
R733	321-0271-00	6.49 k $\Omega$	1/8 W Prec 1%
R735	315-0101-00	100 $\Omega$	1/4 W 5%
R736	315-0101-00	100 $\Omega$	1/4 W 5%
R737	323-0271-00	6.49 k $\Omega$	1/2 W Prec 1%
R738	321-0221-00	1.96 k $\Omega$	1/8 W Prec 1%
R739	315-0152-00	1.5 k $\Omega$	1/4 W 5%
R743	311-0635-00	1 k $\Omega$ , Var	
R744	321-0068-00	49.9 $\Omega$	1/8 W Prec 1%
R745	308-0307-00	5 k $\Omega$	3 W WW 1%
R749	315-0220-00	22 $\Omega$	1/4 W 5%
R750	301-0331-00	330 $\Omega$	1/2 W 5%
R751	315-0181-00	180 $\Omega$	1/4 W 5%
R752	315-0222-00	2.2 k $\Omega$	1/4 W 5%
R753	321-0259-00	4.87 k $\Omega$	1/8 W Prec 1%
R754	322-0338-00	32.4 k $\Omega$	1/4 W Prec 1%
R755	321-0258-00	4.75 k $\Omega$	1/8 W Prec 1%
R756	315-0101-00	100 $\Omega$	1/4 W 5%
R757	303-0912-00	9.1 k $\Omega$	1 W 5%
R758	315-0101-00	100 $\Omega$	1/4 W 5%

For Service Manuals Contact  
**MAURITRON TECHNOLOGIES LTD**  
 8 Cherry Tree Road, Bicester  
 Oxon OX9 3EJ  
 Tel: 01844-351304 Fax: 01844-350354  
 Email: enquiries@mauritron.co.uk

## A4 A SWEEP Circuit Board Assembly (cont)

Ckt. No.	Tektronix Part No.	Serial/Model No. Eff	Disc	Description		
<b>Resistors (cont)</b>						
R759	321-0232-00		2.55 k $\Omega$	$\frac{1}{8}$ W	Prec	1%
R768	315-0910-00		91 $\Omega$	$\frac{1}{4}$ W		5%
R769	315-0202-00		2 k $\Omega$	$\frac{1}{4}$ W		5%
R770	322-0188-00		887 $\Omega$	$\frac{1}{4}$ W	Prec	1%
R771	322-0202-00		1.24 k $\Omega$	$\frac{1}{4}$ W	Prec	1%
R772	321-0141-00		287 $\Omega$	$\frac{1}{8}$ W	Prec	1%
R773	321-0327-00		24.9 k $\Omega$	$\frac{1}{8}$ W	Prec	1%
R774	315-0101-00		100 $\Omega$	$\frac{1}{4}$ W		5%
R775	321-0268-00		6.04 k $\Omega$	$\frac{1}{8}$ W	Prec	1%
R776	315-0270-00		27 $\Omega$	$\frac{1}{4}$ W		5%
R777	321-0182-00		768 $\Omega$	$\frac{1}{8}$ W	Prec	1%
R778	315-0470-00		47 $\Omega$	$\frac{1}{4}$ W		5%
R779	321-0241-00		3.16 k $\Omega$	$\frac{1}{8}$ W	Prec	1%
R780	315-0682-00		6.8 k $\Omega$	$\frac{1}{4}$ W		5%
R781	315-0114-00		110 k $\Omega$	$\frac{1}{4}$ W		5%
R782	315-0392-00		3.9 k $\Omega$	$\frac{1}{4}$ W		5%
R784	315-0222-00		2.2 k $\Omega$	$\frac{1}{4}$ W		5%
R785	315-0102-00		1 k $\Omega$	$\frac{1}{4}$ W		5%
R786	315-0223-00		22 k $\Omega$	$\frac{1}{4}$ W		5%
R787	315-0473-00		47 k $\Omega$	$\frac{1}{4}$ W		5%
R790	321-0268-00		6.04 k $\Omega$	$\frac{1}{8}$ W	Prec	1%
R791	321-0266-00		5.76 k $\Omega$	$\frac{1}{8}$ W	Prec	1%
R793	301-0820-00		82 $\Omega$	$\frac{1}{2}$ W		5%
R794	315-0473-00		47 k $\Omega$	$\frac{1}{4}$ W		5%
R796	315-0622-00		6.2 k $\Omega$	$\frac{1}{4}$ W		5%
R797	321-0265-00		5.62 k $\Omega$	$\frac{1}{8}$ W	Prec	1%
R917	315-0153-00		15 k $\Omega$	$\frac{1}{4}$ W		5%
R1249	315-0470-00		47 $\Omega$	$\frac{1}{4}$ W		5%
R1252	307-0106-00		4.7 $\Omega$	$\frac{1}{4}$ W		5%
R1254	307-0106-00		4.7 $\Omega$	$\frac{1}{4}$ W		5%

**Transformer**

T669	*120-0684-00	Toroid, 2 windings
T670	*120-0684-00	Toroid, 2 windings
T680	*120-0468-00	Toroid, 6 turns, bifilar

**A5 B SWEEP Circuit Board Assembly**

Ckt. No.	Tektronix Part No.	Serial/Model No. Eff	Disc	Description
	*670-0942-00	B010100	B010499	Complete Board
	*670-0942-01	B010500	B019999	Complete Board
	*670-0942-02	B020000	B079999	Complete Board
	*670-0942-03	B080000	B089999	Complete Board
	*670-0942-06	B090000	B149999	Complete Board
	*670-0942-07	B150000		Complete Board

**Capacitors**

Tolerance  $\pm 20\%$  unless otherwise indicated.

C560	283-0080-00			0.022 $\mu\text{F}$	Cer	25 V	+80%—20%
C561	290-0267-00			1 $\mu\text{F}$	Elect.	35 V	
C564	283-0080-00			0.022 $\mu\text{F}$	Cer	25 V	+80%—20%
C568	283-0666-00			890 pF	Mica	100 V	2%
C569	281-0524-00			150 pF	Cer	500 V	
C817	281-0571-00			82 pF	Cer	500 V	
C819	283-0068-00			0.01 $\mu\text{F}$	Cer	500 V	
C823	283-0111-00			0.1 $\mu\text{F}$	Cer	50 V	
C826	281-0523-00			100 pF	Cer	350 V	
C829	283-0080-00			0.022 $\mu\text{F}$	Cer	25 V	+80%—20%
C835	283-0080-00			0.022 $\mu\text{F}$	Cer	25 V	+80%—20%
C841	283-0080-00			0.022 $\mu\text{F}$	Cer	25 V	+80%—20%
C851	283-0080-00			0.022 $\mu\text{F}$	Cer	25 V	+80%—20%
C852	283-0080-00			0.022 $\mu\text{F}$	Cer	25 V	+80%—20%
C859	283-0080-00			0.022 $\mu\text{F}$	Cer	25 V	+80%—20%
C862	283-0111-00			0.1 $\mu\text{F}$	Cer	50 V	
C864	283-0067-00			0.001 $\mu\text{F}$	Cer	200 V	10%
C866	281-0617-00			15 pF	Cer	200 V	
C871	281-0549-00			68 pF	Cer	500 V	10%
C902	281-0525-00			470 pF	Cer	500 V	
C904	281-0518-00	B010100	B019999X	47 pF	Cer	500 V	
C909	290-0267-00			1 $\mu\text{F}$	Elect.	35 V	
C911	290-0267-00			1 $\mu\text{F}$	Elect.	35 V	
C918	283-0080-00			0.022 $\mu\text{F}$	Cer	25 V	+80%—20%
C921	283-0080-00			0.022 $\mu\text{F}$	Cer	25 V	+80%—20%
C925	281-0558-00			18 pF	Cer	500 V	
C929	283-0080-00			0.022 $\mu\text{F}$	Cer	25 V	+80%—20%
C934	283-0178-00			0.1 $\mu\text{F}$	Cer	100 V	+80%—20%
C937	281-0518-00			47 pF	Cer	500 V	
C938	281-0523-00			100 pF	Cer	350 V	
For Service Manuals Contact <b>MAURITRON TECHNICAL SERVICES</b> 8 Cherry Tree Rd, Chinnor Oxon OX9 4QY Tel:- 01044-351634 Fax:- 01044-350554 Email:- enquiries@mauritron.co.uk							
C943	283-0080-00			0.022 $\mu\text{F}$	Cer	25 V	+80%—20%
C946	290-0248-01			150 $\mu\text{F}$	Elect.	15 V	
C958	283-0080-00			0.022 $\mu\text{F}$	Cer	25 V	+80%—20%
C959	281-0523-00			100 pF	Cer	350 V	
C961	283-0080-00			0.022 $\mu\text{F}$	Cer	25 V	+80%—20%
C967	281-0518-00			47 pF	Cer	500 V	
C977	281-0558-00			18 pF	Cer	500 V	
C983	281-0518-00			47 pF	Cer	500 V	
C990	281-0505-00			12 pF	Cer	500 V	10%
C1001	283-0080-00			0.022 $\mu\text{F}$	Cer	25 V	+80%—20%

## A5 B SWEEP Circuit Board Assembly (cont)

Ckt. No.	Tektronix Part No.	Serial/Model No. Eff	Disc	Description
<b>Capacitors (cont)</b>				
C1003	283-0080-00		0.022 $\mu$ F	Cer 25 V +80%—20%
C1009	290-0134-00		22 $\mu$ F	Elect. 15 V
C1028	283-0080-00		0.022 $\mu$ F	Cer 25 V +80%—20%
C1038	283-0067-00		0.001 $\mu$ F	Cer 200 V 10%
C1048	283-0067-00		0.001 $\mu$ F	Cer 200 V 10%
C1056	283-0111-00		0.1 $\mu$ F	Cer 50 V
C1061	283-0083-00		0.0047 $\mu$ F	Cer 500 V 5%
C1068	283-0189-00		0.1 $\mu$ F	Cer 400 V
C1073	281-0538-00		1 pF	Cer 500 V
C1074	281-0064-00		0.25-1.5 pF, Var	Plastic
C1079	281-0511-00		22 pF	Cer 500 V 10%
C1081	283-0083-00		0.0047 $\mu$ F	Cer 500 V 5%
C1093	281-0538-00		1 pF	Cer 500 V
C1094	281-0064-00		0.25-1.5 pF, Var	Plastic
C1095	281-0166-00		1.9-15.7 pF, Var	Air 500 V
C1096	281-0503-00		8 pF	Cer 500 V $\pm 0.5$ pF
C1099	281-0511-00		22 pF	Cer 100 V 10%
C1256	283-0178-00		0.1 $\mu$ F	Cer 25 V +80%—20%
C1257	283-0080-00		0.022 $\mu$ F	Cer 25 V +80%—20%
C1258	283-0059-00		1 $\mu$ F	Cer 25 V +80%—20%
C1259	283-0059-00		1 $\mu$ F	Cer 25 V +80%—20%
C1262	290-0267-00		1 $\mu$ F	Elect. 35 V
C1264	290-0267-00		1 $\mu$ F	Elect. 35 V
C1265	283-0189-00		0.1 $\mu$ F	Cer 400 V
C1266	283-0178-00		0.1 $\mu$ F	Cer 100 V +80%—20%
C1267	283-0111-00		0.1 $\mu$ F	Cer 50 V
C1268	283-0080-00		0.022 $\mu$ F	Cer 25 V +80%—20%
C1269	283-0111-00		0.1 $\mu$ F	Cer 50 V

## Semiconductor Device, Diodes

CR819	*152-0323-00	Silicon	Tek Spec
CR828	*152-0185-00	Silicon	Replaceable by 1N4152
CR833	*152-0185-00	Silicon	Replaceable by 1N4152
CR836	*152-0185-00	Silicon	Replaceable by 1N4152
CR838	*152-0185-00	Silicon	Replaceable by 1N4152
CR851	*152-0185-00	Silicon	Replaceable by 1N4152
CR852	*152-0185-00	Silicon	Replaceable by 1N4152
CR854	*152-0153-00	Silicon	Tek Spec
CR855	*152-0153-00	Silicon	Tek Spec
CR857	152-0310-00	Tunnel	5 mA

**A5 B SWEEP Circuit Board Assembly (cont)**

Ckt. No.	Tektronix Part No.	Serial/Model No. Eff	Disc	Description
<b>Semiconductor Device, Diodes (cont)</b>				
CR871	*152-0153-00		Silicon	Tek Spec
CR901	*152-0153-00		Silicon	Tek Spec
CR902	152-0310-00		Tunnel	5 mA
CR906	*152-0153-00		Silicon	Tek Spec
CR907	*152-0153-00		Silicon	Tek Spec
CR908	*152-0153-00		Silicon	Tek Spec
CR912	*152-0185-00		Silicon	Replaceable by 1N4152
CR922	*152-0185-00		Silicon	Replaceable by 1N4152
CR929	*152-0185-00		Silicon	Replaceable by 1N4152
CR933	*152-0185-00		Silicon	Replaceable by 1N4152
CR936	*152-0185-00		Silicon	Replaceable by 1N4152
CR937	*152-0185-00		Silicon	Replaceable by 1N4152
CR938	*152-0185-00		Silicon	Replaceable by 1N4152
CR948	*152-0185-00		Silicon	Replaceable by 1N4152
CR949	*152-0185-00		Silicon	Replaceable by 1N4152
CR951	*152-0185-00		Silicon	Replaceable by 1N4152
CR952	*152-0185-00		Silicon	Replaceable by 1N4152
CR955	*152-0075-00		Germanium	Tek Spec
CR967	*152-0185-00		Silicon	Replaceable by 1N4152
CR981	*152-0185-00		Silicon	Replaceable by 1N4152
CR982	*152-0185-00		Silicon	Replaceable by 1N4152
CR991	*152-0185-00		Silicon	Replaceable by 1N4152
CR992	*152-0185-00		Silicon	Replaceable by 1N4152
CR993	*152-0185-00		Silicon	Replaceable by 1N4152
CR995	152-0307-00		Silicon	Dual
CR1024	*152-0153-00		Silicon	Tek Spec
CR1025	*152-0153-00		Silicon	Tek Spec
CR1030	*152-0153-00		Silicon	Tek Spec
CR1031	*152-0153-00		Silicon	Tek Spec
CR1032	*152-0153-00		Silicon	Tek Spec
CR1033	*152-0153-00		Silicon	Tek Spec
VR841	152-0278-00		Zener	1N4372A 400 mW, 3 V, 5%
VR842	152-0278-00		Zener	1N4372A 400 mW, 3 V, 5%

For Service Manuals Contact  
**MAURITRON TECHNICAL SERVICES**  
 8 Cherry Tree Rd, Chinnor  
 Oxon OX9 4QY  
 Tel: 01044-351034 Fax: 01044-350554  
 Email: enquiries@mauratron.co.uk

**Relays**

K566	*108-0431-00	Reed drive
K566S1	260-0839-00	Mag reed SPST
K1028	*108-0431-00	Reed drive
K1028S1	260-0839-00	Mag reed SPST

## A5 B SWEEP Circuit Board Assembly (cont)

Ckt. No.	Tektronix Part No.	Serial/Model No. Eff	Disc	Description
<b>Inductors</b>				
L568	*114-0229-00			2.2-4.4 $\mu$ H, Var Core 276-0506-00
L836	276-0507-00			Core, ferramic suppressor
L838	276-0507-00			Core, ferramic suppressor
L851	276-0507-00			Core, ferramic suppressor
L852	276-0507-00			Core, ferramic suppressor
L856	*108-0619-00			90 nH
L864	*108-0620-00			90 nH
L925	276-0507-00			Core, ferramic suppressor
L1024	276-0528-00	XB080000		Core, ferramic suppressor
L1039	*108-0215-00			1.1 $\mu$ H
L1049	*108-0215-00			1.1 $\mu$ H
L1072	276-0507-00			Core, ferramic suppressor
L1092	276-0507-00			Core, ferramic suppressor
L1259	*120-0382-00			Toroid, 14 turns, single
L1266	*108-0440-00			8 $\mu$ H
L1267	*108-0440-00			8 $\mu$ H
L1269	*108-0440-00			8 $\mu$ H
<b>Transistors</b>				
Q823	151-1025-00			Silicon FET N channel, junction type TO-18 X55
Q826	*151-0259-00			Silicon NPN TO-106 Selected from 2N3563
Q836	*151-0259-00			Silicon NPN TO-106 Selected from 2N3563
Q846	*151-0259-00			Silicon NPN TO-106 Selected from 2N3563
Q864	*151-0271-00			Silicon PNP TO-18 Tek Spec
Q904	151-0131-00			Germanium PNP TO-18 2N964
Q910	151-0223-00			Silicon NPN TO-18 2N4275
Q912	151-0224-00			Silicon NPN TO-18 2N3692
Q919	*151-0283-00			Silicon NPN TO-72 Tek Spec
Q921	151-1025-00			Silicon FET N channel, junction type, TO-18 X55
Q925	*151-0127-00			Silicon NPN TO-18 Selected from 2N2369
Q927	151-0220-00			Silicon PNP TO-18 2N4122
Q929	*151-0133-00	B010100	B019999	Silicon PNP TO-18 Tek Spec
Q929	151-0188-00	B020000		Silicon PNP TO-92 2N3906
Q938	*151-0261-00			Silicon PNP TO-78 Dual, Tek Spec
Q948	151-0223-00			Silicon NPN TO-18 2N4275
Q954	*151-0190-01			Silicon NPN TO-106 Tek Spec
Q963	151-0188-00			Silicon PNP TO-92 2N3906
Q969	151-0188-00			Silicon PNP TO-92 2N3906
Q974	151-0188-00			Silicon PNP TO-92 2N3906
Q978	151-0188-00			Silicon PNP TO-92 2N3906

## A5 B SWEEP Circuit Board Assembly (cont)

Ckt. No.	Tektronix Part No.	Serial/Model No. Eff	Disc	Description		
<b>Transistors (cont)</b>						
Q984	151-0188-00			Silicon	PNP	TO-92 2N3906
Q986	151-0188-00			Silicon	PNP	TO-92 2N3906
Q996	151-1004-00			Silicon	FET	TO-18 N channel, junction type
Q998	151-0224-00			Silicon	NPN	TO-18 2N3692
Q1012	*151-0127-00	B010100	B079999	Silicon	NPN	TO-18 Selected from 2N2369
Q1012 <sup>35</sup>	*153-0600-00	B080000		Silicon	NPN	Potted assembly
Q1016	*151-0127-00	B010100	B079999	Silicon	NPN	TO-18 Selected from 2N2369
Q1016 <sup>35</sup>	*153-0600-00	B080000		Silicon	NPN	Potted assembly
Q1018	*151-0271-00			Silicon	PNP	TO-18 Tek Spec
Q1020	*151-0271-00			Silicon	PNP	TO-18 Tek Spec
Q1038	*151-0271-00			Silicon	PNP	TO-18 Tek Spec
Q1048	*151-0271-00			Silicon	PNP	TO-18 Tek Spec
Q1051	151-0220-00			Silicon	PNP	TO-18 2N4122
Q1053	151-0220-00			Silicon	PNP	TO-18 2N4122
Q1055	*151-0127-00			Silicon	NPN	TO-18 Selected from 2N2369
Q1058	151-0221-00			Silicon	PNP	TO-18 2N4258
Q1060	*151-0127-00			Silicon	NPN	TO-18 Selected from 2N2369
Q1064	*151-0274-00			Silicon	NPN	TO-5 Selected from 2N3501
Q1066	*151-0270-00			Silicon	PNP	TO-5 Tek Spec
Q1078	*151-0127-00			Silicon	NPN	TO-18 Selected from 2N2369
Q1080	151-0221-00			Silicon	PNP	TO-18 2N4258
Q1084	*151-0274-00			Silicon	NPN	TO-5 Selected from 2N3501
Q1086	*151-0270-00			Silicon	PNP	TO-5 Tek Spec
Q1098	*151-0127-00			Silicon	NPN	TO-18 Selected from 2N2369

For Service Manuals Contact  
**MAURITRON LTD**  
 8 Cherry Tree Lane, Bicester  
 Oxon OX9 3EY  
 Tel: 01294-351634 Fax: 01294-350354  
 Email: enquiries@mauritron.co.uk

## Resistors

Resistors are fixed, composition,  $\pm 10\%$  unless otherwise indicated.

R560	315-0100-00	10 $\Omega$	$\frac{1}{4}$ W		5%
R561	323-0151-00	365 $\Omega$	$\frac{1}{2}$ W	Prec	1%
R563	321-0110-00	137 $\Omega$	$\frac{1}{8}$ W	Prec	1%
R564	301-0151-00	150 $\Omega$	$\frac{1}{2}$ W		5%
R565	321-0190-00	931 $\Omega$	$\frac{1}{8}$ W	Prec	1%
R569	311-0643-00	50 $\Omega$ , Var			
R815	323-0612-00	950 k $\Omega$	$\frac{1}{2}$ W	Prec	1%
R817	321-0356-00	49.9 k $\Omega$	$\frac{1}{8}$ W	Prec	1%
R819	315-0105-00	1 M $\Omega$	$\frac{1}{4}$ W		5%
R823	315-0270-00	27 $\Omega$	$\frac{1}{4}$ W		5%
R824	315-0151-00	150 $\Omega$	$\frac{1}{4}$ W		5%
R825	315-0272-00	2.7 k $\Omega$	$\frac{1}{4}$ W		5%
R826	315-0471-00	470 $\Omega$	$\frac{1}{4}$ W		5%
R828	315-0183-00	18 k $\Omega$	$\frac{1}{4}$ W		5%
R829	315-0162-00	1.6 k $\Omega$	$\frac{1}{4}$ W		5%

<sup>35</sup>Q1012 and Q1016 furnished as a unit.



## A5 B SWEEP Circuit Board Assembly (cont)

Ckt. No.	Tektronix Part No.	Serial/Model No. Eff	Disc	Description	
Resistors (cont)					
R833	315-0183-00			18 k $\Omega$	1/4 W 5%
R835	315-0162-00			1.6 k $\Omega$	1/4 W 5%
R837	315-0162-00			1.6 k $\Omega$	1/4 W 5%
R840	315-0510-00			51 $\Omega$	1/4 W 5%
R841	315-0113-00			11 k $\Omega$	1/4 W 5%
R842	315-0133-00			13 k $\Omega$	1/4 W 5%
R843	311-0510-00	B010100	B129999	10 k $\Omega$ , Var	
R843	311-1228-00	B130000		10 k $\Omega$ , Var	
R844	315-0272-00			2.7 k $\Omega$	1/4 W 5%
R845	315-0752-00			7.5 k $\Omega$	1/4 W 5%
R846	315-0331-00			330 $\Omega$	1/4 W 5%
R848	315-0122-00			1.2 k $\Omega$	1/4 W 5%
R851	315-0101-00			100 $\Omega$	1/4 W 5%
R852	315-0101-00			100 $\Omega$	1/4 W 5%
R856	315-0181-00			180 $\Omega$	1/4 W 5%
R857	315-0472-00			4.7 k $\Omega$	1/4 W 5%
R858	315-0431-00			430 $\Omega$	1/4 W 5%
R859	315-0100-00			10 $\Omega$	1/4 W 5%
R864	301-0273-00			27 k $\Omega$	1/2 W 5%
R866	317-0560-00			56 $\Omega$	1/8 W 5%
R871	315-0103-00			10 k $\Omega$	1/4 W 5%
R901	315-0101-00			100 $\Omega$	1/4 W 5%
R902	315-0330-00			33 $\Omega$	1/4 W 5%
R903	315-0472-00			4.7 k $\Omega$	1/4 W 5%
R904	321-0176-00			665 $\Omega$	1/8 W Prec 1%
R905	315-0752-00			7.5 k $\Omega$	1/4 W 5%
R907	315-0680-00			68 $\Omega$	1/4 W 5%
R909	315-0220-00			22 $\Omega$	1/4 W 5%
R910	323-0152-00			374 $\Omega$	1/2 W Prec 1%
R911	315-0100-00			10 $\Omega$	1/4 W 5%
R912	301-0751-00			750 $\Omega$	1/2 W 5%
R913	315-0101-00			100 $\Omega$	1/4 W 5%
R914	321-0203-00			1.27 k $\Omega$	1/8 W Prec 1%
R916	315-0331-00			330 $\Omega$	1/4 W 5%
R918	321-0175-00			649 $\Omega$	1/8 W Prec 1%
R919	316-0101-00			100 $\Omega$	1/4 W 5%
R920	315-0101-00			100 $\Omega$	1/4 W 5%
R921	315-0470-00			47 $\Omega$	1/4 W 5%
R922	315-0470-00			47 $\Omega$	1/4 W 5%
R923	321-0271-00			6.49 k $\Omega$	1/8 W Prec 1%
R924	315-0470-00			47 $\Omega$	1/4 W 5%

## A5 B SWEEP Circuit Board Assembly (cont)

Ckt. No.	Tektronix Part No.	Serial/Model No. Eff	Disc	Description		
<b>Resistors (cont)</b>						
R926	315-0101-00		100 $\Omega$	$\frac{1}{4}$ W		5%
R927	323-0284-00		8.87 k $\Omega$	$\frac{1}{2}$ W	Prec	1%
R928	321-0222-00		2 k $\Omega$	$\frac{1}{8}$ W	Prec	1%
R929	315-0152-00		1.5 k $\Omega$	$\frac{1}{4}$ W		5%
R932	311-0635-00		1 k $\Omega$ , Var			
R933	308-0307-00		5 k $\Omega$	3 W	WW	1%
R934	315-0470-00		47 $\Omega$	$\frac{1}{4}$ W		5%
R935	303-0103-00		10 k $\Omega$	1 W		5%
R936	315-0101-00		100 $\Omega$	$\frac{1}{4}$ W		5%
R937	315-0101-00		100 $\Omega$	$\frac{1}{4}$ W		5%
R938	315-0181-00		180 $\Omega$	$\frac{1}{4}$ W		5%
R939	321-0232-00		2.55 k $\Omega$	$\frac{1}{8}$ W	Prec	1%
R940	315-0220-00		22 $\Omega$	$\frac{1}{4}$ W		5%
R942	323-0294-00		11.3 k $\Omega$	$\frac{1}{2}$ W	Prec	1%
R943	311-0658-00		500 $\Omega$ , Var			
R944	321-0296-00		11.8 k $\Omega$	$\frac{1}{8}$ W	Prec	1%
R945	321-0080-00		66.5 $\Omega$	$\frac{1}{8}$ W	Prec	1%
R946	321-0126-00		200 $\Omega$	$\frac{1}{8}$ W	Prec	1%
R948	315-0302-00		3 k $\Omega$	$\frac{1}{4}$ W		5%
R949	321-0261-00		5.11 k $\Omega$	$\frac{1}{8}$ W	Prec	1%
R950	315-0333-00		33 k $\Omega$	$\frac{1}{4}$ W		5%
R951	315-0362-00		3.6 k $\Omega$	$\frac{1}{4}$ W		5%
R954	315-0103-00		10 k $\Omega$	$\frac{1}{4}$ W		5%
R956	315-0103-00		10 k $\Omega$	$\frac{1}{4}$ W		5%
R957	315-0303-00		30 k $\Omega$	$\frac{1}{4}$ W		5%
<p>For Service Manuals Contact  MAURITRON TECHNICAL CO. LTD  8 Cherry Tree Rd, Chalfont  Oxon OX9 4QY  Tel: 01844-351004 Fax: 01844-351054  Email: enquiries@maurifron.co.uk</p>						
R958	315-0224-00		220 k $\Omega$	$\frac{1}{4}$ W		5%
R959	315-0101-00		100 $\Omega$	$\frac{1}{4}$ W		5%
R960	321-0245-00		3.48 k $\Omega$	$\frac{1}{8}$ W	Prec	1%
R961	315-0562-00		5.6 k $\Omega$	$\frac{1}{4}$ W		5%
R962	315-0101-00		100 $\Omega$	$\frac{1}{4}$ W		5%
R964	321-0198-00		1.13 k $\Omega$	$\frac{1}{8}$ W	Prec	1%
R966	321-0223-00		2.05 k $\Omega$	$\frac{1}{8}$ W	Prec	1%
R967	321-0226-00		2.21 k $\Omega$	$\frac{1}{8}$ W	Prec	1%
R968	321-0184-00		806 $\Omega$	$\frac{1}{8}$ W	Prec	1%
R970	315-0103-00		10 k $\Omega$	$\frac{1}{4}$ W		5%
R971	315-0203-00		20 k $\Omega$	$\frac{1}{4}$ W		5%
R972	315-0103-00		10 k $\Omega$	$\frac{1}{4}$ W		5%
R973	321-0152-00		374 $\Omega$	$\frac{1}{8}$ W	Prec	1%
R975	321-0198-00		1.13 k $\Omega$	$\frac{1}{8}$ W	Prec	1%
R976	321-0223-00		2.05 k $\Omega$	$\frac{1}{8}$ W	Prec	1%

## A5 B SWEEP Circuit Board Assembly (cont)

Ckt. No.	Tektronix Part No.	Serial/Model No. Eff	Disc	Description			
<b>Resistors (cont)</b>							
R977	321-0226-00			2.21 k $\Omega$	1/8 W	Prec	1%
R978	321-0184-00			806 $\Omega$	1/8 W	Prec	1%
R980	321-0333-00			28.7 k $\Omega$	1/8 W	Prec	1%
R981	321-0320-00			21 k $\Omega$	1/8 W	Prec	1%
R982	321-0237-00			2.87 k $\Omega$	1/8 W	Prec	1%
R984	315-0751-00			750 $\Omega$	1/4 W		5%
R986	301-0822-00			8.2 k $\Omega$	1/2 W		5%
R987	315-0152-00			1.5 k $\Omega$	1/4 W		5%
R988	301-0822-00			8.2 k $\Omega$	1/2 W		5%
R989	315-0122-00			1.2 k $\Omega$	1/4 W		5%
R990	315-0562-00			5.6 k $\Omega$	1/4 W		5%
R991	301-0622-00			6.2 k $\Omega$	1/2 W		5%
R992	315-0122-00			1.2 k $\Omega$	1/4 W		5%
R993	315-0471-00			470 $\Omega$	1/4 W		5%
R996	315-0101-00			100 $\Omega$	1/4 W		5%
R998	321-0177-00			681 $\Omega$	1/8 W	Prec	1%
R999	321-0245-00			3.48 k $\Omega$	1/8 W	Prec	1%
R1001	315-0124-00			120 k $\Omega$	1/4 W		5%
R1003	315-0152-00			1.5 k $\Omega$	1/4 W		5%
R1004	315-0332-00			3.3 k $\Omega$	1/4 W		5%
R1005	321-0034-00			22.1 $\Omega$	1/8 W	Prec	1%
R1007	321-0001-00	B010100	B149999	10 $\Omega$	1/8 W	Prec	1%
R1007	321-0020-00	B150000		15.8 $\Omega$	1/8 W	Prec	1%
RT1007	307-0122-00	XB150000		50 $\Omega$	Thermal		
R1008	321-0216-00			1.74 k $\Omega$	1/8 W	Prec	1%
R1009	315-0470-00			47 $\Omega$	1/4 W		5%
R1010	321-0239-00			3.01 k $\Omega$	1/8 W	Prec	1%
R1012	303-0752-00			7.5 k $\Omega$	1 W		5%
R1013	321-0231-00			2.49 k $\Omega$	1/8 W	Prec	1%
R1015	322-0193-00			1 k $\Omega$	1/4 W	Prec	1%
R1016	303-0752-00			7.5 k $\Omega$	1 W		5%
R1017	321-0231-00			2.49 k $\Omega$	1/8 W	Prec	1%
R1018	321-0329-00			26.1 k $\Omega$	1/8 W	Prec	1%
R1019	323-0183-00			787 $\Omega$	1/2 W	Prec	1%
R1020	321-0329-00			26.1 k $\Omega$	1/8 W	Prec	1%
R1021	323-0271-00			6.49 k $\Omega$	1/2 W	Prec	1%
R1022	323-0271-00			6.49 k $\Omega$	1/2 W	Prec	1%
R1024	311-0635-00			1 k $\Omega$ , Var			
R1025	321-0210-00			1.5 k $\Omega$	1/8 W	Prec	1%
R1026	311-0622-00			100 $\Omega$ , Var			
R1027	321-0107-00			127 $\Omega$	1/8 W	Prec	1%
R1028	301-0151-00			150 $\Omega$	1/2 W		5%

## A5 B SWEEP Circuit Board Assembly (cont)

Ckt. No.	Tektronix Part No.	Serial/Model No. Eff	Disc	Description		
Resistors (cont)						
R1030	315-0562-00			5.6 k $\Omega$	1/4 W	5%
R1031	311-0644-00			20 k $\Omega$ , Var		
R1032	315-0562-00			5.6 k	1/4 W	5%
R1034	321-0097-00			100 $\Omega$	1/8 W	Prec 1%
R1035	321-0106-00			124 $\Omega$	1/8 W	Prec 1%
R1036	321-0097-00			100 $\Omega$	1/8 W	Prec 1%
R1038	315-0241-00	B010100	B010499	240 $\Omega$	1/4 W	5%
R1038	315-0201-00	B010500		200 $\Omega$	1/4 W	5%
R1039	322-0133-00			237 $\Omega$	1/4 W	Prec 1%
R1042	321-0077-00			61.9 $\Omega$	1/8 W	Prec 1%
R1044	322-0164-00			499 $\Omega$	1/4 W	Prec 1%
R1045	321-0164-00			499 $\Omega$	1/8 W	Prec 1%
R1046	322-0164-00			499 $\Omega$	1/4 W	Prec 1%
R1048	315-0241-00	B010100	B010499	240 $\Omega$	1/4 W	5%
R1048	315-0201-00	B010500		200 $\Omega$	1/4 W	5%
R1049	322-0133-00			237 $\Omega$	1/4 W	Prec 1%
R1055	323-0117-00			162 $\Omega$	1/2 W	Prec 1%
R1056	321-0154-00			392 $\Omega$	1/8 W	Prec 1%
R1058	322-0084-00			73.2 $\Omega$	1/4 W	Prec 1%
R1059	321-0183-00			787 $\Omega$	1/8 W	Prec 1%
R1060	323-0169-00			562 $\Omega$	1/2 W	Prec 1%
R1065	303-0273-00			27 k $\Omega$	1 W	5%
R1066	323-0227-00	B010100	B089999	2.26 k $\Omega$	1/2 W	Prec 1%
R1066	323-0215-00	B090000		1.69 k $\Omega$	1/2 W	Prec 1%
R1067	315-0470-00			47 $\Omega$	1/4 W	5%
R1068	323-0349-00			42.2 k $\Omega$	1/2 W	Prec 1%
R1069	323-0349-00			42.2 k $\Omega$	1/2 W	Prec 1%
R1070	323-0253-00	B010100	B089999	4.22 k $\Omega$	1/2 W	Prec 1%
R1070	323-0237-00	B090000		2.87 k $\Omega$	1/2 W	Prec 1%
R1072	315-0101-00			100 $\Omega$	1/4 W	5%
R1073	322-0605-00			10.1 k $\Omega$	1/4 W	Prec 1%
R1074	322-0287-00			9.53 k $\Omega$	1/4 W	Prec 1%
R1076	321-0243-00			3.32 k $\Omega$	1/8 W	Prec 1%
R1077	321-0222-00			2 k $\Omega$	1/8 W	Prec 1%
R1078	321-0212-00			1.58 k $\Omega$	1/8 W	Prec 1%
R1079	321-0126-00			200 $\Omega$	1/8 W	Prec 1%
R1080	322-0107-00			127 $\Omega$	1/4 W	Prec 1%
R1082	321-0166-00			523 $\Omega$	1/8 W	Prec 1%
R1083	321-0175-00			649 $\Omega$	1/8 W	Prec 1%
R1085	303-0273-00			27 k $\Omega$	1 W	5%
R1086	323-0227-00	B010100	B089999	2.26 k $\Omega$	1/2 W	Prec 1%
R1086	323-0215-00	B090000		1.69 k $\Omega$	1/2 W	Prec 1%
R1087	315-0470-00	B010100	B079999	47 $\Omega$	1/4 W	5%
R1087	315-0151-00	B080000		150 $\Omega$	1/4 W	5%
R1092	315-0101-00			100 $\Omega$	1/4 W	5%
R1093	322-0605-00			10.1 k $\Omega$	1/4 W	Prec 1%

**A5 B SWEEP Circuit Board Assembly (cont)**

Ckt. No.	Tektronix Part No.	Serial/Model No. Eff	Disc	Description		
<b>Resistors (cont)</b>						
R1094	322-0287-00		9.53 kΩ	1/4 W	Prec	1%
R1095	311-0633-00		5 kΩ, Var			
R1096	321-0243-00		3.32 kΩ	1/8 W	Prec	1%
R1097	321-0222-00		2 kΩ	1/8 W	Prec	1%
R1098	321-0212-00		1.58 kΩ	1/8 W	Prec	1%
R1099	321-0126-00		200 Ω	1/8 W	Prec	1%
R1256	315-0101-00		100 Ω	1/4 W		5%
R1257	315-0220-00		22 Ω	1/4 W		5%
R1258	315-0470-00		47 Ω	1/4 W		5%
R1259	315-0220-00		22 Ω	1/4 W		5%
R1262	307-0106-00		4.7 Ω	1/4 W		5%
R1264	307-0106-00		4.7 Ω	1/4 W		5%
R1265	315-0101-00		100 Ω	1/4 W		5%
R1268	315-0220-00		22 Ω	1/4 W		5%

**Transformer**

T870	*120-0468-00	Toroid, 6 turns, bifilar
------	--------------	--------------------------

For Service Manuals Contact  
**MAURITON TECHNOLOGICAL SERVICES**  
 8 Cherry Tree Rd, Chinnor  
 Oxon OX9 4CY  
 Tel: 01844-301331 Fax: 01211-253554  
 Email: enquiries@mauriton.co.uk

**A6 CALIBRATOR Circuit Board Assembly**

\*670-0937-00

Complete Board

**Capacitors**

Tolerance ±20% unless otherwise indicated.

C1271	290-0267-00	1 μF	Elect.	35 V	
C1275	285-0595-00	0.1 μF	PTM	100 V	1%
C1286	283-0010-00	0.05 μF	Cer	50 V	
C1294	281-0518-00	47 pF	Cer	500 V	

**Transistors**

Q1275	151-0224-00	Silicon	NPN	TO-18	2N3692
Q1285	151-0224-00	Silicon	NPN	TO-18	2N3692
Q1294	151-0220-00	Silicon	PNP	TO-18	2N4122

**A6 CALIBRATOR Circuit Board Assembly (cont)**

Ckt. No.	Tektronix Part No.	Serial/Model No. Eff	Disc	Description		
<b>Resistors</b>						
Resistors are fixed, composition, $\pm 10\%$ unless otherwise indicated.						
R1271	315-0120-00		12 $\Omega$	1/4 W		5%
R1274	316-0471-00		470 $\Omega$	1/4 W		
R1275	315-0472-00		4.7 k $\Omega$	1/4 W		5%
R1284	316-0222-00		2.2 k $\Omega$	1/4 W		
R1285	315-0682-00		6.8 k $\Omega$	1/4 W		5%
R1286	316-0471-00		470 $\Omega$	1/4 W		
R1296	321-0649-00		2.19 k $\Omega$	1/8 W	Prec	1/4%
R1298	322-0126-06		200 $\Omega$	1/4 W	Prec	1/4%
R1299	321-1080-01		67.3 $\Omega$	1/8 W	Prec	1/2%

**Transformer**

T1275	*120-0460-00	Calibrator frequency
-------	--------------	----------------------

**A7 LOW VOLTAGE REGULATOR Circuit Board Assembly**

\*670-0938-00

Complete Circuit

**Capacitors**

Tolerance  $\pm 20\%$  unless otherwise indicated.

C1116	290-0267-00	1 $\mu\text{F}$	Elect.	35 V	
C1127	283-0078-00	0.001 $\mu\text{F}$	Cer	500 V	
C1153	283-0078-00	0.001 $\mu\text{F}$	Cer	500 V	
C1155	290-0286-00	50 $\mu\text{F}$	Elect.	25 V	+75%—10%
C1184	283-0092-00	0.03 $\mu\text{F}$	Cer	200 V	+80%—20%
C1192	283-0083-00	0.0047 $\mu\text{F}$	Cer	500 V	5%
C1195	290-0305-00	3 $\mu\text{F}$	Elect.	150 V	
C1196	290-0198-00	17 $\mu\text{F}$	Elect.	150 V	+30%—15%

**Semiconductor Device, Diodes**

CR1120	*152-0185-00	Silicon	Replaceable by 1N4152
CR1125	152-0066-00	Silicon	1N3194
CR1154	*152-0185-00	Silicon	Replaceable by 1N4152
CR1158	*152-0185-00	Silicon	Replaceable by 1N4152
CR1159	*152-0185-00	Silicon	Replaceable by 1N4152

## A7 LOW VOLTAGE REGULATOR Circuit Board Assembly (cont)

Ckt. No.	Tektronix Part No.	Serial/Model No. Eff	Disc	Description
<b>Semiconductor Device, Diodes (cont)</b>				
CR1185	*152-0185-00		Silicon	Replaceable by 1N4152
CR1189	*152-0185-00		Silicon	Replaceable by 1N4152
CR1193	*152-0185-00		Silicon	Replaceable by 1N4152
CR1196	152-0066-00		Silicon	1N3194
VR1116	152-0212-00		Zener	1N936 500 mW, 9 V, 5% TC
VR1182	152-0282-00		Zener	1N972B 400 mW, 30 V, 5%
VR1184	152-0268-00		Zener	1N979B 400 mW, 56 V, 5%
VR1190	152-0195-00		Zener	1N751A 400 mW, 5.1 V, 5%

## Transistors

Q1116	151-0224-00		Silicon	NPN TO-18	2N3692
Q1119	151-0224-00		Silicon	NPN TO-18	2N3692
Q1124	151-0224-00		Silicon	NPN TO-18	2N3692
Q1149	151-0224-00		Silicon	NPN TO-18	2N3692
Q1154	151-0224-00		Silicon	NPN TO-18	2N3692

Q1184	151-0224-00		Silicon	NPN TO-18	2N3692
Q1193	151-0223-00		Silicon	NPN TO-18	2N4275
Q1194	151-0224-00		Silicon	NPN TO-18	2N3692

For Service Manuals Contact  
**MAURITRON TECHNOLOGIES LTD**  
 8 Cherry Tree Road, Oxon  
 Oxon OX9 4QY  
 Tel: 01844-351694 Fax: 01844-351694  
 Email: enquiries@mauritron.co.uk

## Resistors

Resistors are fixed, composition,  $\pm 10\%$  unless otherwise indicated.

R1116	316-0101-00	100 $\Omega$	$\frac{1}{4}$ W		
R1117	323-0154-00	392 k $\Omega$	$\frac{1}{2}$ W	Prec	1%
R1118	301-0273-00	27 k $\Omega$	$\frac{1}{2}$ W		5%
R1119	308-0224-00	0.3 $\Omega$	2 W	WW	
R1120	315-0561-00	560 $\Omega$	$\frac{1}{4}$ W		5%
R1123	321-0212-00	1.58 $\Omega$	$\frac{1}{8}$ W	Prec	1%
R1124	311-0515-00	250 $\Omega$ , Var			
R1125	321-0160-00	453 $\Omega$	$\frac{1}{8}$ W	Prec	1%
R1149	308-0244-00	0.3 $\Omega$	2 W	WW	
R1153	301-0243-00	24 k $\Omega$	$\frac{1}{2}$ W		5%
R1155	316-0221-00	220 $\Omega$	$\frac{1}{4}$ W		
R1157	323-0205-00	1.33 k $\Omega$	$\frac{1}{2}$ W	Prec	1%
R1158	311-0514-00	100 $\Omega$ , Var			
R1159	323-0205-00	1.33 k $\Omega$	$\frac{1}{2}$ W	Prec	1%
R1182	301-0123-00	12 k $\Omega$	$\frac{1}{2}$ W		5%
R1183	301-0303-00	30 k $\Omega$	$\frac{1}{2}$ W		5%
R1184	316-0102-00	1 k $\Omega$	$\frac{1}{4}$ W		
R1187	323-0308-00	15.8 k $\Omega$	$\frac{1}{2}$ W	Prec	1%
R1188	311-0515-00	250 $\Omega$ , Var			
R1189	321-0230-00	2.43 k $\Omega$	$\frac{1}{8}$ W	Prec	1%

**A7 LOW VOLTAGE REGULATOR Circuit Board Assembly (cont)**

Ckt. No.	Tektronix Part No.	Serial/Model No. Eff	Disc	Description		
<b>Resistors (cont)</b>						
R1190	308-0103-00		2.5 k $\Omega$	5 W	WW	1%
R1192	315-0470-00		47 $\Omega$	1/4 W		5%
R1193	321-0157-00		422 $\Omega$	1/8 W	Prec	1%
R1194	323-0345-00		38.3 k $\Omega$	1/2 W	Prec	1%
R1195	316-0102-00		1 k $\Omega$	1/4 W		

**A8 Z AXIS Circuit Board Assembly**

\*670-0940-00

Complete Board

**Capacitors**

Tolerance  $\pm 20\%$  unless otherwise indicated.

C1303	283-0080-00		0.022 $\mu$ F	Cer	25 V	+80%—20%
C1311	283-0003-00		0.01 $\mu$ F	Cer	150 V	
C1316	283-0080-00		0.022 $\mu$ F	Cer	25 V	+80%—20%
C1321	283-0080-00		0.022 $\mu$ F	Cer	25 V	+80%—20%
C1322	281-0547-00		2.7 pF	Cer	500 V	10%
C1324	283-0083-00		0.0047 $\mu$ F	Cer	500 V	5%
C1326	283-0092-00		0.03 $\mu$ F	Cer	200 V	+80%—20%
C1333	283-0080-00		0.022 $\mu$ F	Cer	25 V	+80%—20%
C1346	283-0080-00		0.022 $\mu$ F	Cer	25 V	+80%—20%
C1351	281-0547-00		2.7 pF	Cer	500 V	10%
C1352	281-0064-00		0.25-1.5 pF, Var	Plastic		
C1353	283-0092-00		0.03 $\mu$ F	Cer	200 V	+80%—20%
C1356	283-0092-00		0.03 $\mu$ F	Cer	200 V	+80%—20%
C1358	283-0092-00		0.03 $\mu$ F	Cer	200 V	+80%—20%
C1402	285-0919-00		0.22 $\mu$ F	Plastic	100 V	10%
C1419	285-0622-00		0.1 $\mu$ F	PTM	100 V	
C1482	283-0003-00		0.01 $\mu$ F	Cer	150 V	

**Semiconductor Device, Diodes**

CR1314	*152-0153-00	Silicon	Tek Spec
CR1318	*152-0153-00	Silicon	Tek Spec
CR1326	*152-0107-00	Silicon	Replaceable by 1N647
CR1343	*152-0185-00	Silicon	Replaceable by 1N4152
CR1353	*152-0107-00	Silicon	Replaceable by 1N647



## A8 Z AXIS Circuit Board Assembly (cont)

Ckt. No.	Tektronix Part No.	Serial/Model No. Eff	Disc	Description
<b>Semiconductor Device, Diodes (cont)</b>				
CR1355	*152-0061-00		Silicon	Tek Spec
CR1357	*152-0061-00		Silicon	Tek Spec
VR1356	152-0022-00		Zener	MOT 1M25Z5 1 W, 25 V, 5%
<b>Inductor</b>				
L1314	276-0528-00			Core, ferramic suppressor
<b>Transistors</b>				
Q1314	*151-0259-00		Silicon	NPN TO-106 Selected from 2N3563
Q1323	151-0223-00		Silicon	NPN TO-18 2N4275
Q1324	151-0214-00		Silicon	PNP TO-5 2N3495
Q1334	*151-0124-00		Silicon	NPN TO-5 Selected from 2N3119
Q1343	*151-0124-00		Silicon	NPN TO-5 Selected from 2N3119
Q1413	151-0220-00		Silicon	PNP TO-18 2N4122
Q1414	*151-0126-00		Silicon	NPN TO-18 Replaceable by 2N2484
Q1423	*151-0136-00		Silicon	NPN TO-5 Replaceable by 2N3053
<b>Resistors</b>				
Resistors are fixed, composition, $\pm 10\%$ unless otherwise indicated.				
R1303	315-0123-00		12 k $\Omega$	$\frac{1}{4}$ W 5%
R1304	315-0123-00		12 k $\Omega$	$\frac{1}{4}$ W 5%
R1305	321-0241-00		3.16 k $\Omega$	$\frac{1}{8}$ W Prec 1%
R1307	316-0470-00		47 $\Omega$	$\frac{1}{4}$ W
R1308	301-0473-00		47 k $\Omega$	$\frac{1}{2}$ W 5%
R1309	316-0470-00		47 $\Omega$	$\frac{1}{4}$ W
R1311	316-0471-00		470 $\Omega$	$\frac{1}{4}$ W
R1312	323-0318-00		20 k $\Omega$	$\frac{1}{2}$ W Prec 1%
R1315	321-0241-00		3.16 k $\Omega$	$\frac{1}{8}$ W Prec 1%
R1316	316-0101-00		100 $\Omega$	$\frac{1}{4}$ W
<p style="text-align: center;">For Service Manuals Contact  <b>MAURITRON</b> LTD        8 Cherry Tree Lane, Bicester        Oxon OX9 4DZ        Tel: 01844-351894 Fax: 01844-351554        Email: enquiries@mauritron.co.uk</p>				
R1320	315-0221-00		220 $\Omega$	$\frac{1}{4}$ W 5%
R1321	315-0390-00		39 $\Omega$	$\frac{1}{4}$ W 5%
R1324	316-0102-00		1 k $\Omega$	$\frac{1}{4}$ W
R1326	301-0243-00		24 k $\Omega$	$\frac{1}{2}$ W 5%
R1327	315-0240-00		24 $\Omega$	$\frac{1}{4}$ W 5%
R1330	315-0121-00		120 $\Omega$	$\frac{1}{4}$ W 5%
R1332	301-0122-00		1.2 k $\Omega$	$\frac{1}{2}$ W 5%
R1333	316-0470-00		47 $\Omega$	$\frac{1}{4}$ W
R1344	301-0680-00		68 $\Omega$	$\frac{1}{2}$ W 5%
R1345	305-0822-00		8.2 k $\Omega$	2 W 5%
R1346	316-0101-00		100 $\Omega$	$\frac{1}{4}$ W
R1351	323-0335-00		30.1 k $\Omega$	$\frac{1}{2}$ W Prec 1%
R1353	316-0101-00		100 $\Omega$	$\frac{1}{4}$ W
R1354	305-0183-00		18 k $\Omega$	2 W 5%
R1357	316-0101-00		100 $\Omega$	$\frac{1}{4}$ W

**A8 Z AXIS Circuit Board Assembly (cont)**

Ckt. No.	Tektronix Part No.	Serial/Model No. Eff	Disc	Description			
<b>Resistors (cont)</b>							
R1358	308-0348-00			3.32 kΩ	3 W	WW	1%
R1401	311-0465-00	B010100	B129999	100 kΩ, Var			
R1401	311-1235-00	B130000		100 kΩ, Var			
R1402	301-0435-00			4.3 MΩ	1/2 W		5%
R1414	316-0103-00			10 kΩ	1/4 W		
R1415	316-0102-00			1 kΩ	1/4 W		
R1416	315-0474-00			470 kΩ	1/4 W		5%
R1417	316-0101-00			100 Ω	1/4 W		
R1418	316-0104-00			100 kΩ	1/4 W		
R1425	301-0303-00			30 kΩ	1/2 W		5%
R1482	311-0465-00	B010100	B129999	100 kΩ, Var			
R1482	311-1235-00	B130000		100 kΩ, Var			

For Service Manuals Contact  
**MAURITON TECHNICAL SERVICES LTD**  
 8 Cherry Tree Rd, Leamington  
 Oxon OX9 4CY  
 Tel:- 01844-351094 Fax:- 01844-250554  
 Email:- enquiries@mauriton.co.uk

# SECTION 8

## DIAGRAMS AND CIRCUIT BOARD ILLUSTRATIONS

### Symbols and Reference Designators

Electrical components shown on the diagrams are in the following units unless noted otherwise:

Capacitors = Values one or greater are in picofarads (pF).  
 Values less than one are in microfarads ( $\mu$ F).  
 Resistors = Ohms ( $\Omega$ )

Symbols used on the diagrams are based on USA Standard Y32.2-1967.

The following special symbols are used on the diagrams:

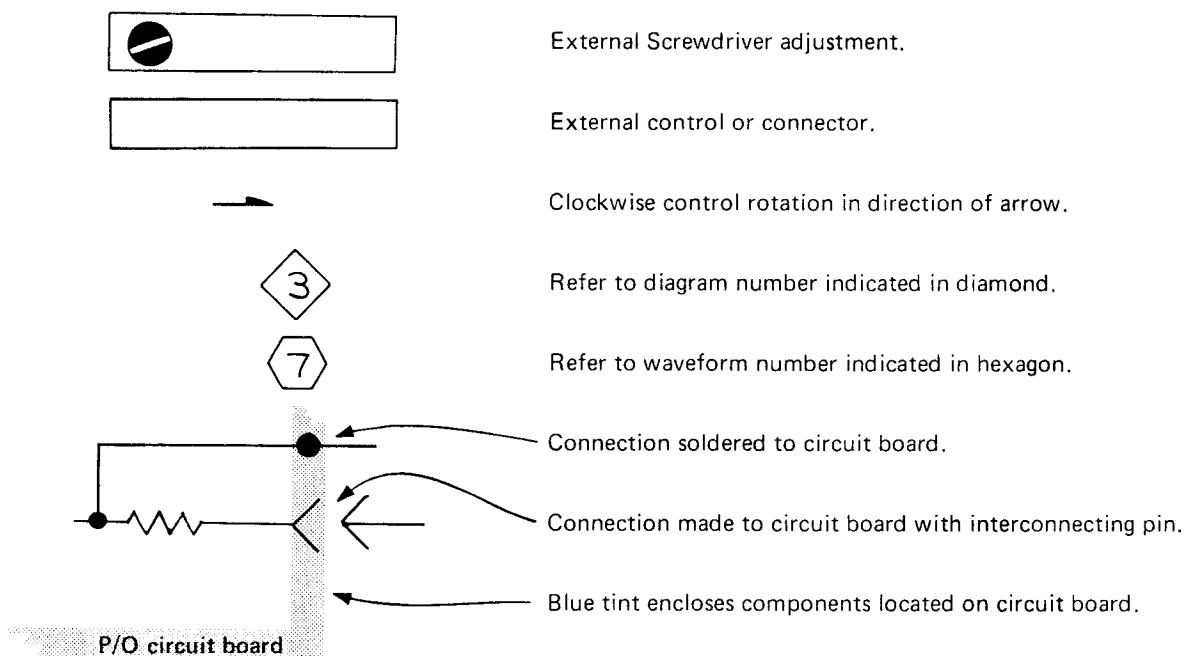

The following prefix letters are used as reference designators to identify components or assemblies on the diagrams.

A	Assembly, separable or repairable (circuit board, etc.)	LR	Inductor/resistor combination
AT	Attenuator, fixed or variable	M	Meter
B	Motor	Q	Transistor or silicon-controlled rectifier
BT	Battery	P	Connector, movable portion
C	Capacitor, fixed or variable	R	Resistor, fixed or variable
CR	Diode, signal or rectifier	RT	Thermistor
DL	Delay line	S	Switch
DS	Indicating device (lamp)	T	Transformer
F	Fuse	TP	Test point
FL	Filter	U	Assembly, inseparable or non-repairable (integrated circuit, etc.)
H	Heat dissipating device (heat sink, heat radiator, etc.)	V	Electron tube
HR	Heater	VR	Voltage regulator (zener diode, etc.)
J	Connector, stationary portion	Y	Crystal
K	Relay		
L	Inductor, fixed or variable		

# VOLTAGE AND WAVEFORM TEST CONDITIONS

Typical voltage measurements and waveform photographs were obtained under the following conditions unless noted otherwise on the individual diagrams:

### Test Oscilloscope (with 10X Probe)

Frequency response	DC to 40 megahertz
Deflection factor (with probe)	50 millivolts to 50 volts/ division
Input impedance	10 megohms, 13.5 picofarads
Probe ground	454A chassis ground
Trigger Source	External to indicate true time relationship between signals
Recommended type (as used on waveforms on diagrams)	Tektronix 7704 with 7A16 plug-in unit and P6052 Probe in 10X position.

### Voltmeter

Type	Digital multimeter
Input impedance	10 megohms
Range	0 to 200 volts
Reference voltage	454A chassis ground
Recommended type (as used for voltages on diagrams)	Tektronix 7704 with 7D13 Digital Multimeter Plug-In Unit

### 454A Conditions

Line voltage	115 volts
Signal applied	Calibrator output signal con- nected to INPUT CH 1 and INPUT CH 2 connectors for waveforms only
Connectors	No connections
Trace position	Centered
Control settings	As follows except as noted otherwise on individual dia- grams:

### CRT Controls

INTENSITY	Midrange
FOCUS	Adjust for focused display
SCALE ILLUM	As desired
BANDWIDTH-BEAM FINDER	FULL

### Vertical Controls (both channels if applicable)

VOLTS/DIV	.2
VAR	CAL
POSITION	Midrange
Input Coupling	DC
MODE	CH 1
TRIGGER	NORM
INVERT	Pushed in

### Triggering Controls (both A and B if applicable)

LEVEL	0
SLOPE	+
COUPLING	AC
SOURCE	INT

### Sweep Controls

DELAY-TIME	0.10
MULTIPLIER	
A TIME/DIV	1 ms
B TIME/DIV	1 ms
A VARIABLE	CAL
A SWEEP MODE	AUTO TRIG
B SWEEP MODE	TRIGGERABLE AFTER DELAY TIME
HORIZ DISPLAY	A
MAG	OFF
A SWEEP LENGTH	FULL
POSITION	Midrange
FINE	Midrange
POWER	ON

### Side-Panel Controls

B TIME/DIV VARIABLE	CAL
------------------------	-----

All voltages given on the diagrams are in volts. Waveforms shown are actual waveform photographs taken with a Tektronix Oscilloscope Camera System and Projected Graticule.

Voltages and waveforms on the diagrams (shown in blue) are not absolute and may vary between instruments because of differing component tolerances, internal calibration or front-panel control settings.

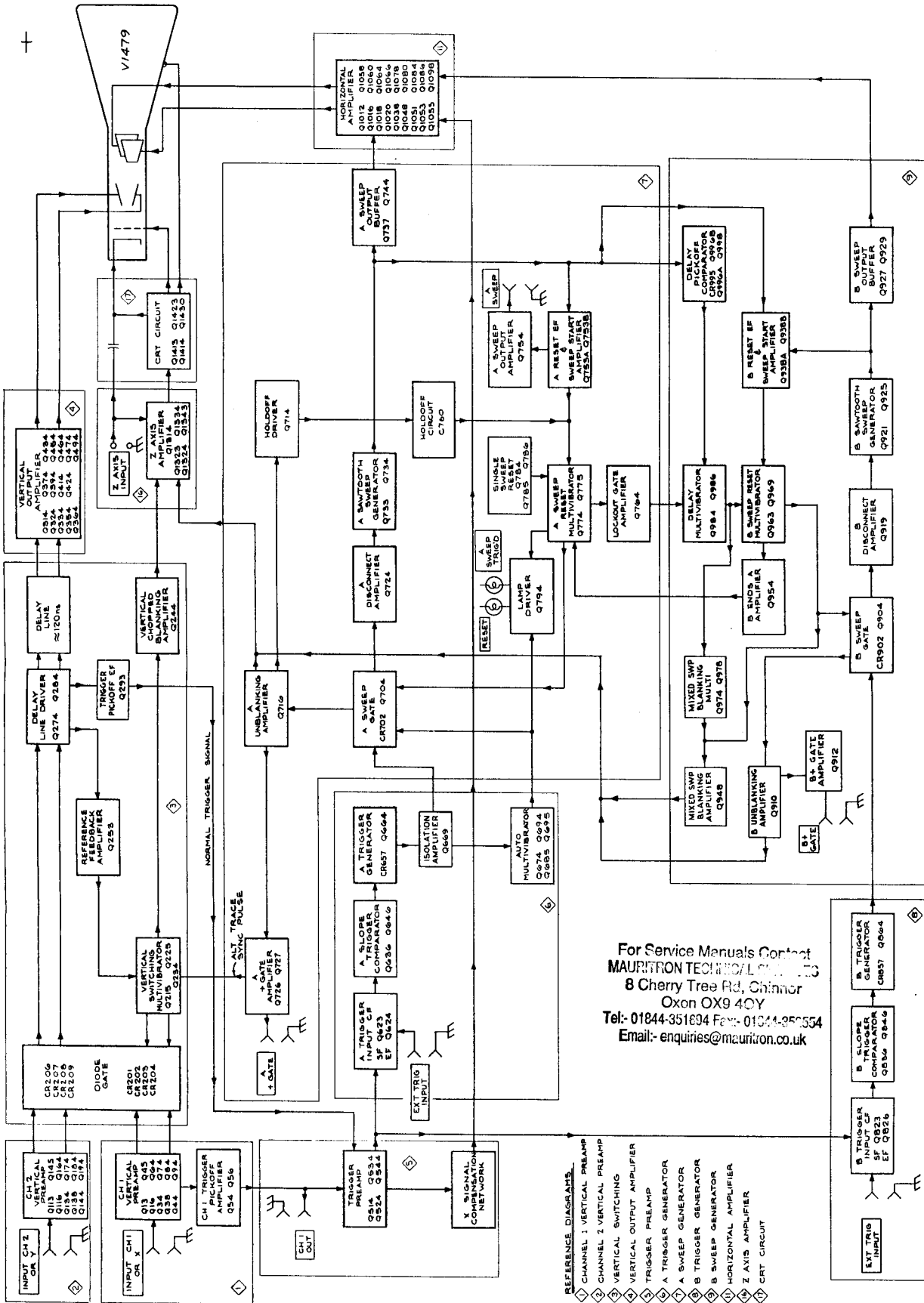

- REFERENCE DIAGRAMS
- ① CHANNEL 1 VERTICAL PREAMP
  - ② CHANNEL 2 VERTICAL PREAMP
  - ③ VERTICAL SWITCHING
  - ④ VERTICAL OUTPUT AMPLIFIER
  - ⑤ TRIGGER PREAMP
  - ⑥ A TRIGGER GENERATOR
  - ⑦ A SWEEP GENERATOR
  - ⑧ B TRIGGER GENERATOR
  - ⑨ B SWEEP GENERATOR
  - ⑩ HORIZONTAL AMPLIFIER
  - ⑪ CRT CIRCUIT

For Service Manuals Contact  
**MAURITRON TECHNOLOGIES**  
 8 Cherry Tree Rd, Chinnor  
 Oxon OX9 4OY  
 Tel: 01844-351694 Fax: 01844-352354  
 Email: enquiries@mauritron.co.uk

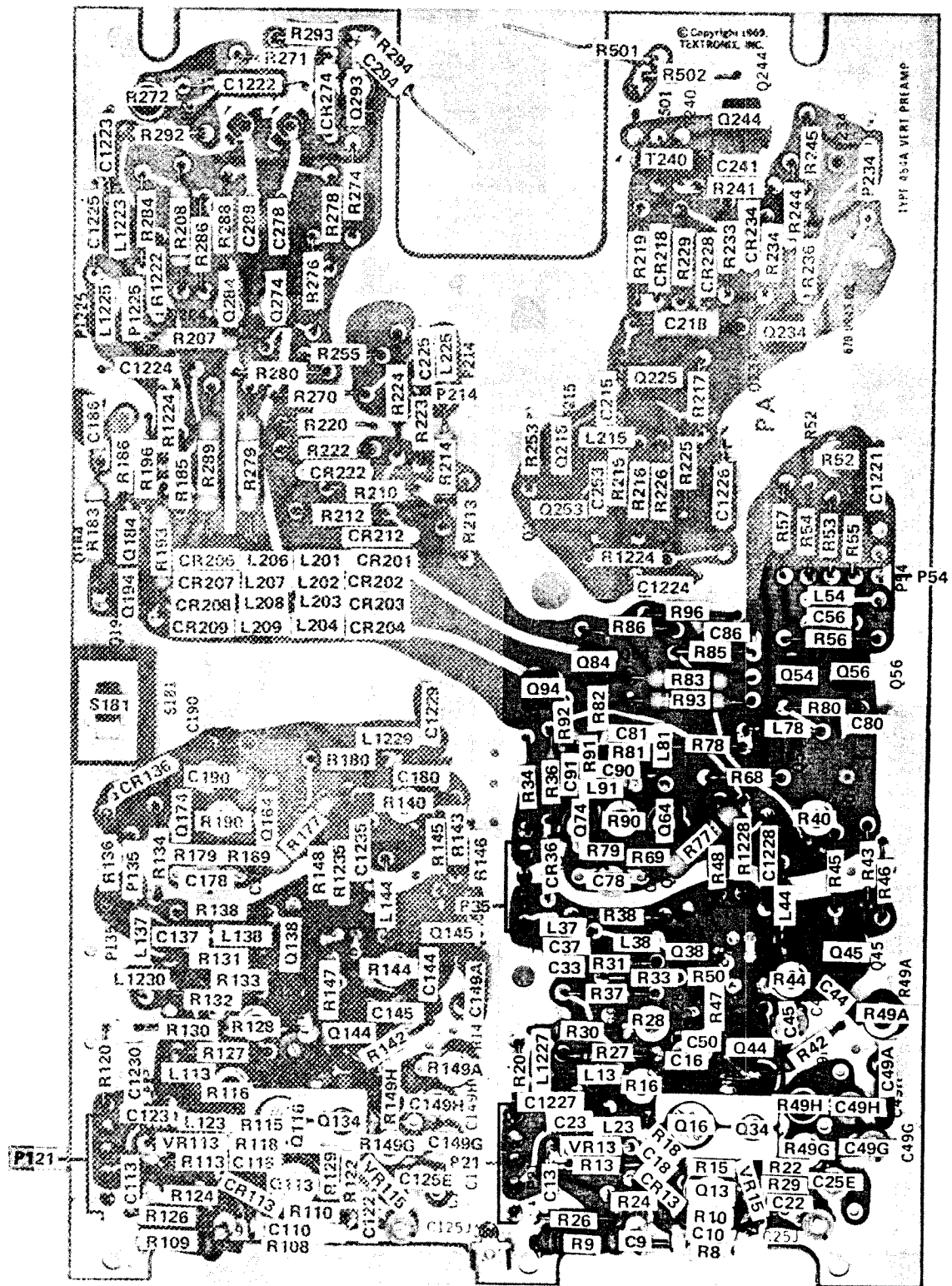
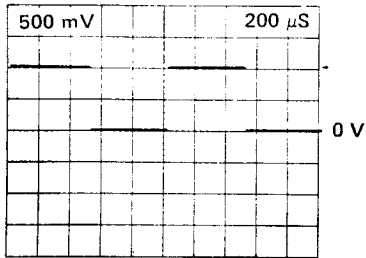
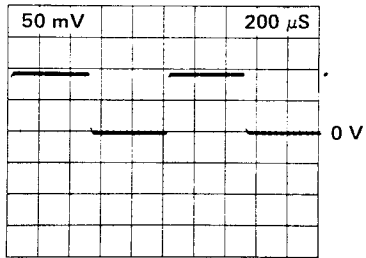

Fig. 8-1. Partial Vertical Preamp circuit board—P/O A1. Channel 1 Vertical Preamp circuit shown.

1



2



3

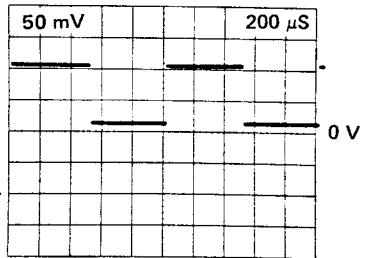

4

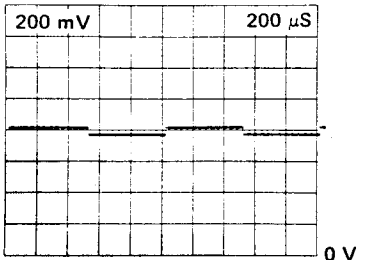

5

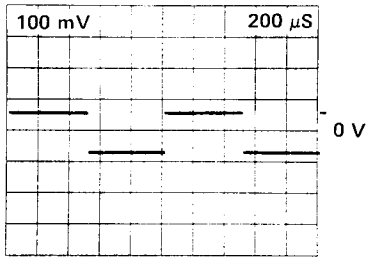

6

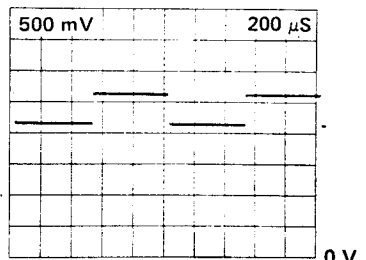

7

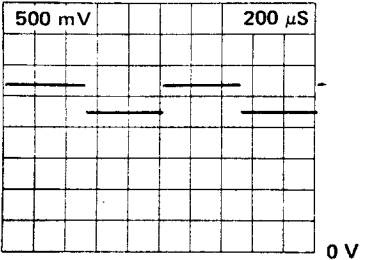

8

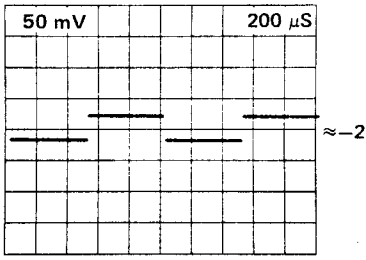

9

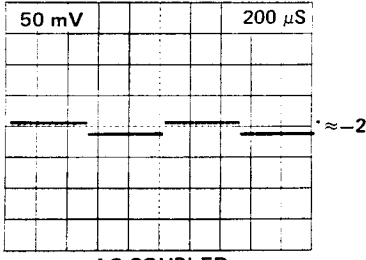

10

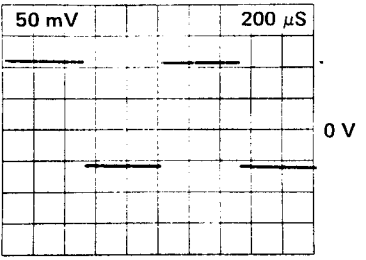

For Service Manuals Contact  
 MAURITON TELECOMMUNICATIONS  
 8 Cherry Tree Lane, Broomfield  
 Oxford OX2 0DQ  
 Tel: 01844-331144 Fax: 01844-331154  
 Email: enquiries@mauriton.co.uk

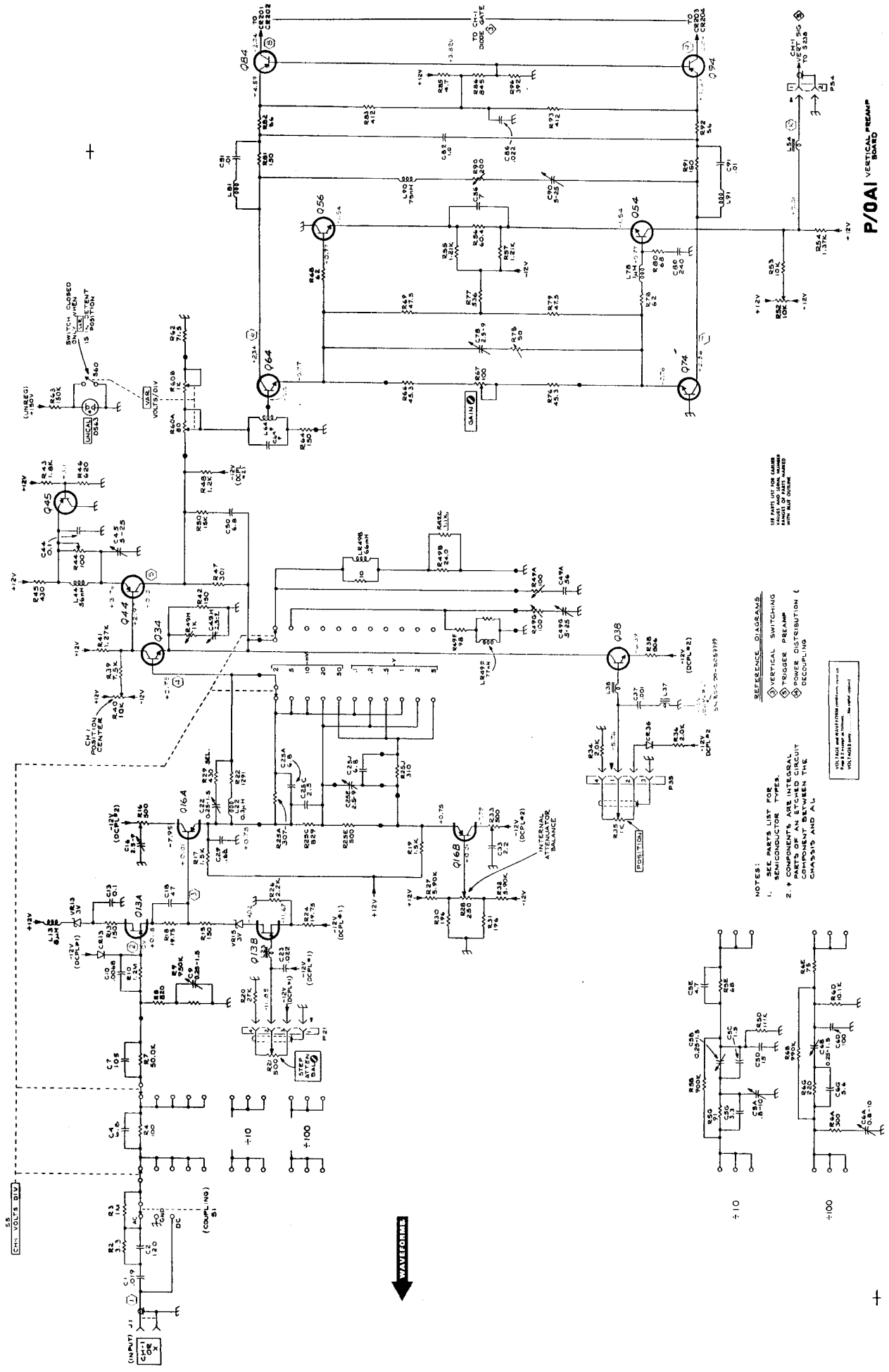

- NOTES:
1. SEE PARTS LIST FOR RESISTOR AND CAPACITOR VALUES.
  2. \* COMPONENTS ARE INTEGRAL PARTS OF AN ETCHED CIRCUIT COMPONENT BETWEEN THE CHASSIS AND AL.

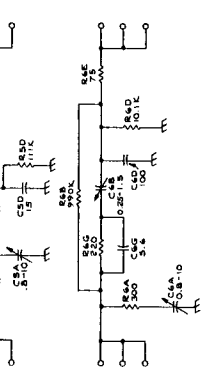

SEE PARTS LIST FOR VALUES OF RESISTORS AND CAPACITORS. \* INTEGRAL PARTS OF ETCHED CIRCUIT COMPONENTS.

P/001 VERTICAL PREAMP BOARD



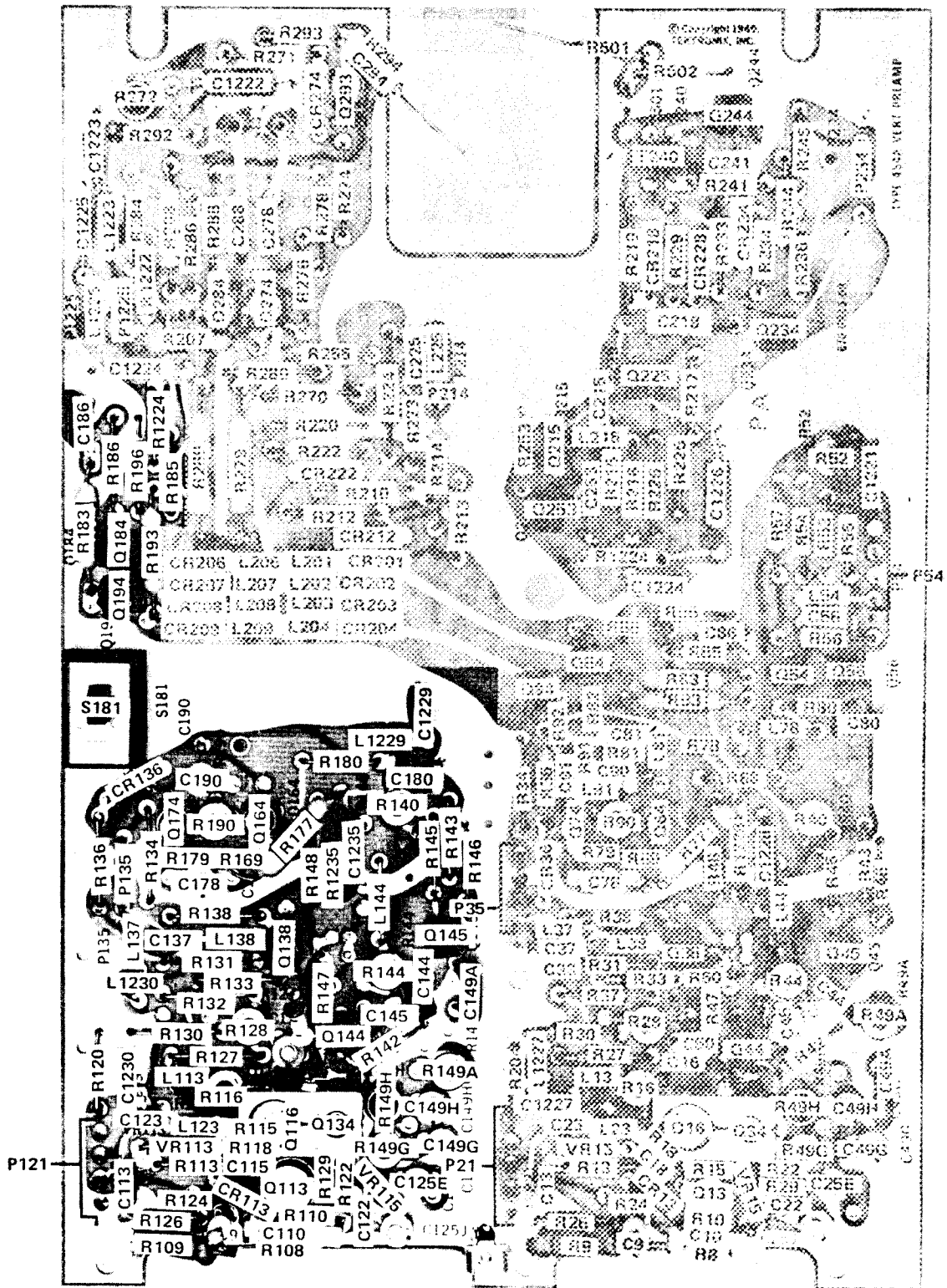
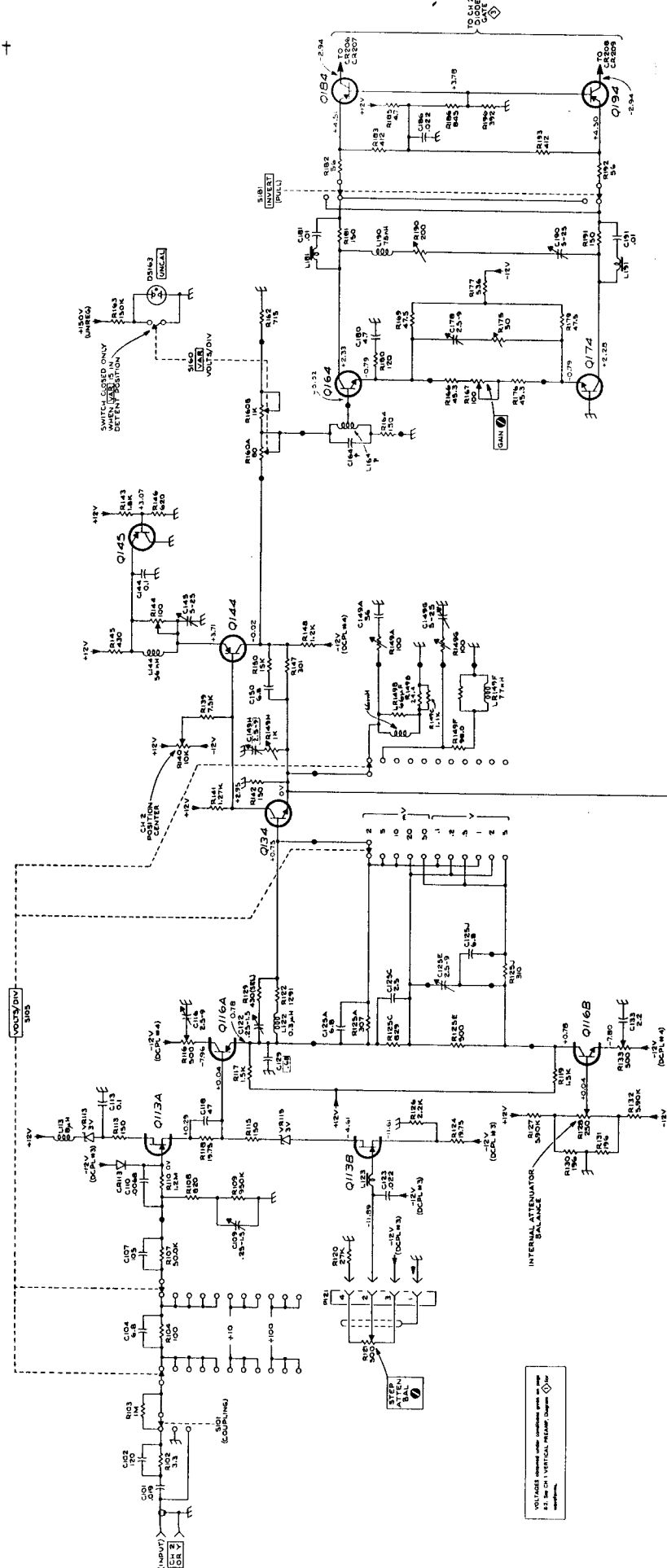

Fig. 8-2. Partial Vertical Preamp circuit board—P/O A1. Channel 2 Vertical Preamp circuit shown.

For Service Manuals Contact  
 MAURITRON TECHNICAL SERVICES LTD  
 8 Cherry Tree Lane, Boreham  
 Oxon OX8 5DZ  
 Tel: 01844-351694 Fax: 01844-351695  
 Email: enquiries@mauritron.co.uk



REFERENCE DIAGRAMS  
 ① VERTICAL SWITCHING  
 ② POWER DISTRIBUTION & DECOUPLING

NOTE 1: SEE PART LIST FOR VALUES OF RESISTORS AND CAPACITORS WITH BUT WITHOUT  
 NOTE 2: 1. SEMICONDUCTOR TYPES  
 2. 2 COMPONENTS ARE INTEGRAL PARTS OF AN ETCHED CIRCUIT COMPONENT BETWEEN THE CHASSIS AND A1

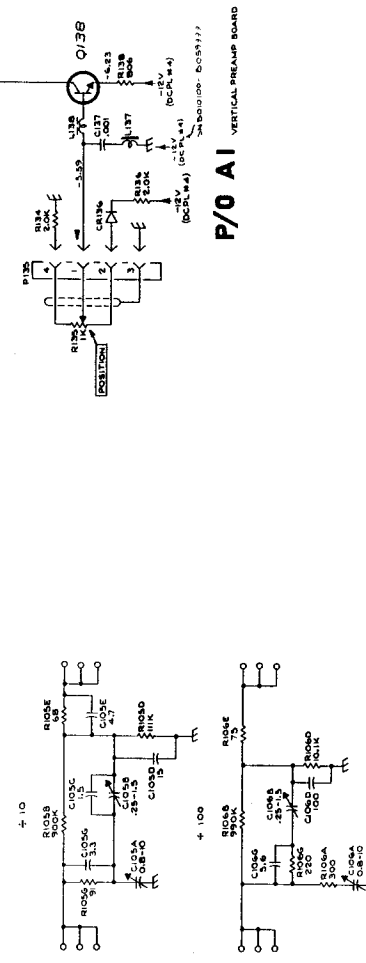

P/O A1 VERTICAL PREAMP BOARD

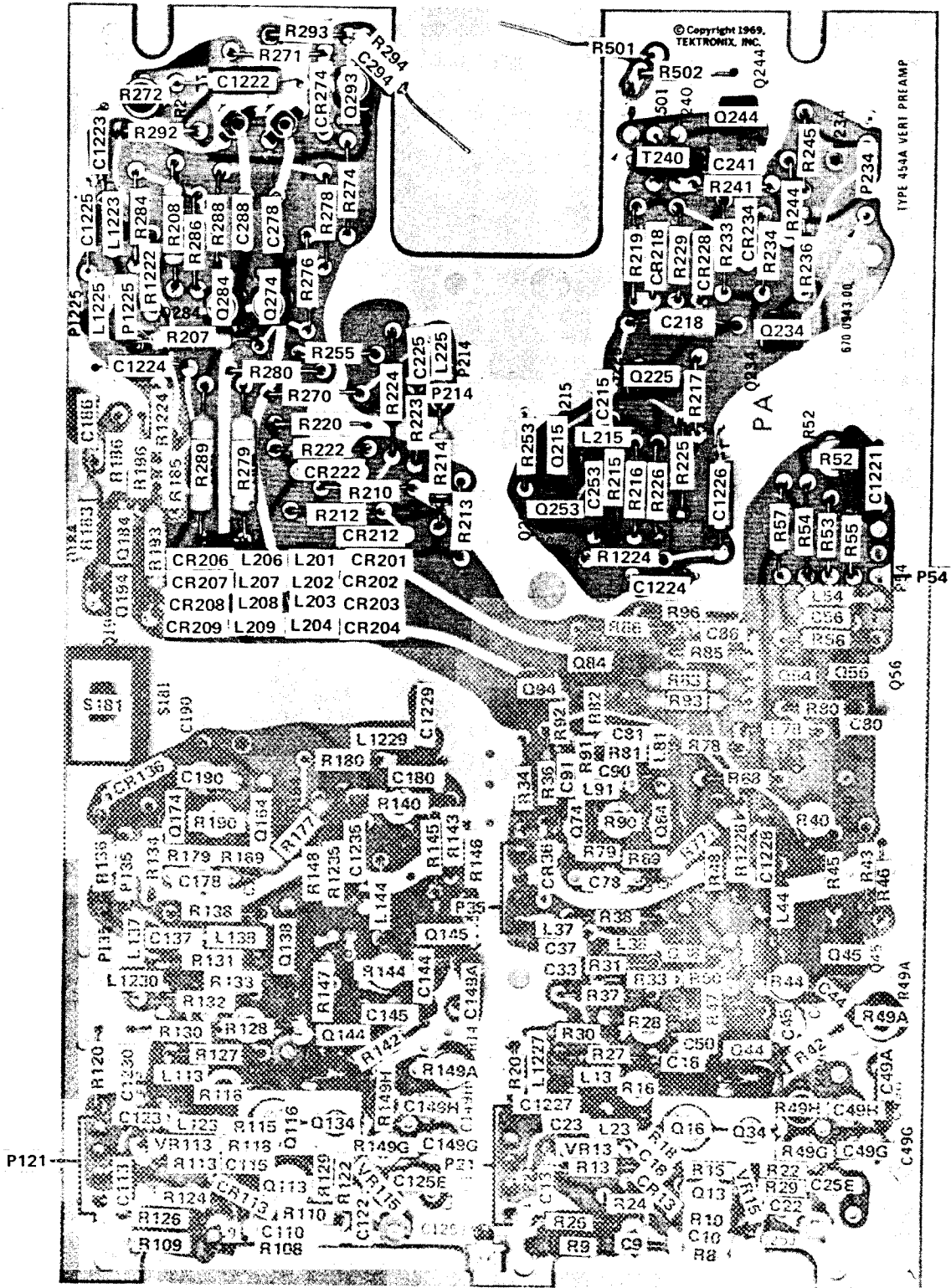
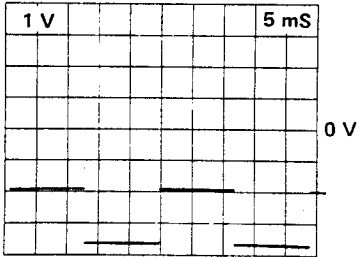

Fig. 8-3. Partial Vertical Preamp circuit board—P/O A1. Vertical Switching circuit shown.

For Service Manual's Contact  
 MAURITRON TECHNICAL SERVICES LTD  
 8 Cherry Tree Rd  
 Oxon OX9 4...  
 Tel: 01844-551304 Fax: 01844-551304  
 Email: enquires@mauratron.co.uk

1\*



2\*\*

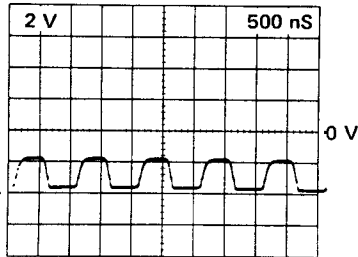

3\*

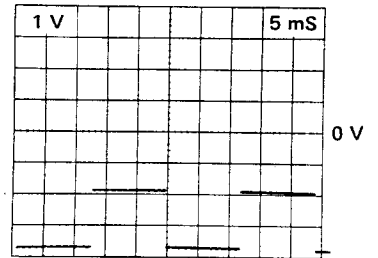

4\*\*

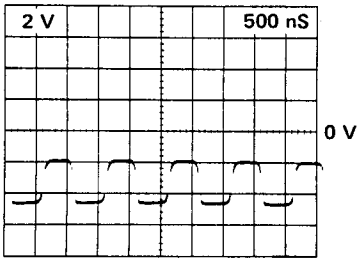

5\*\*

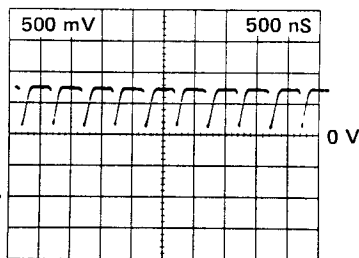

6\*\*

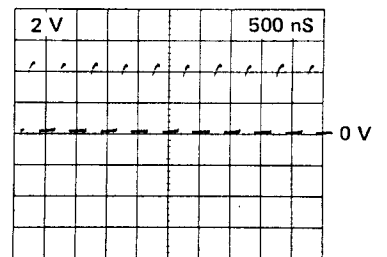

7\*\*

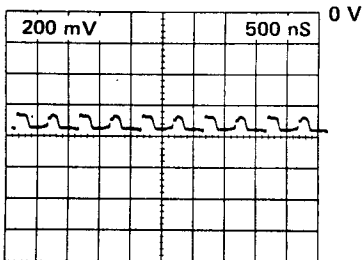

8

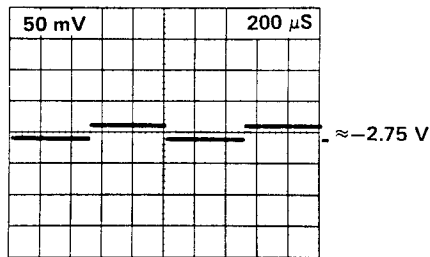

AC COUPLED

9

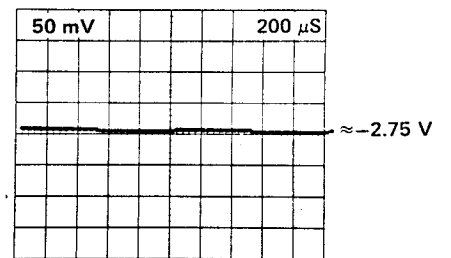

AC COUPLED

10

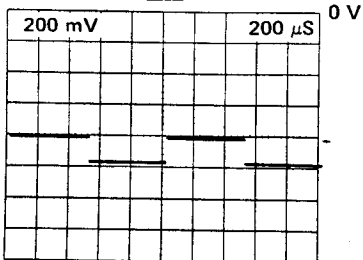

11

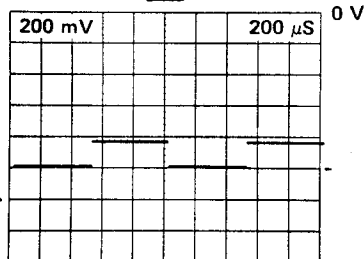

12

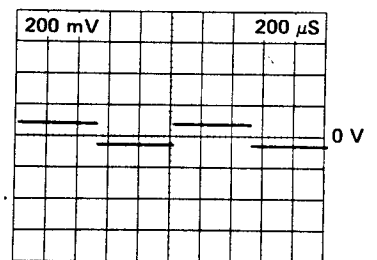

For Service Manuals Contact  
 MAURITRON TECHNICAL SERVICES  
 8 Chiswick Trade Rd, Chiswick  
 Uxbridge, Middx, U.K. UB8 3JY  
 Tel: 01844-851094 Fax: 01844-851054  
 Email: enquiries@mauritron.co.uk

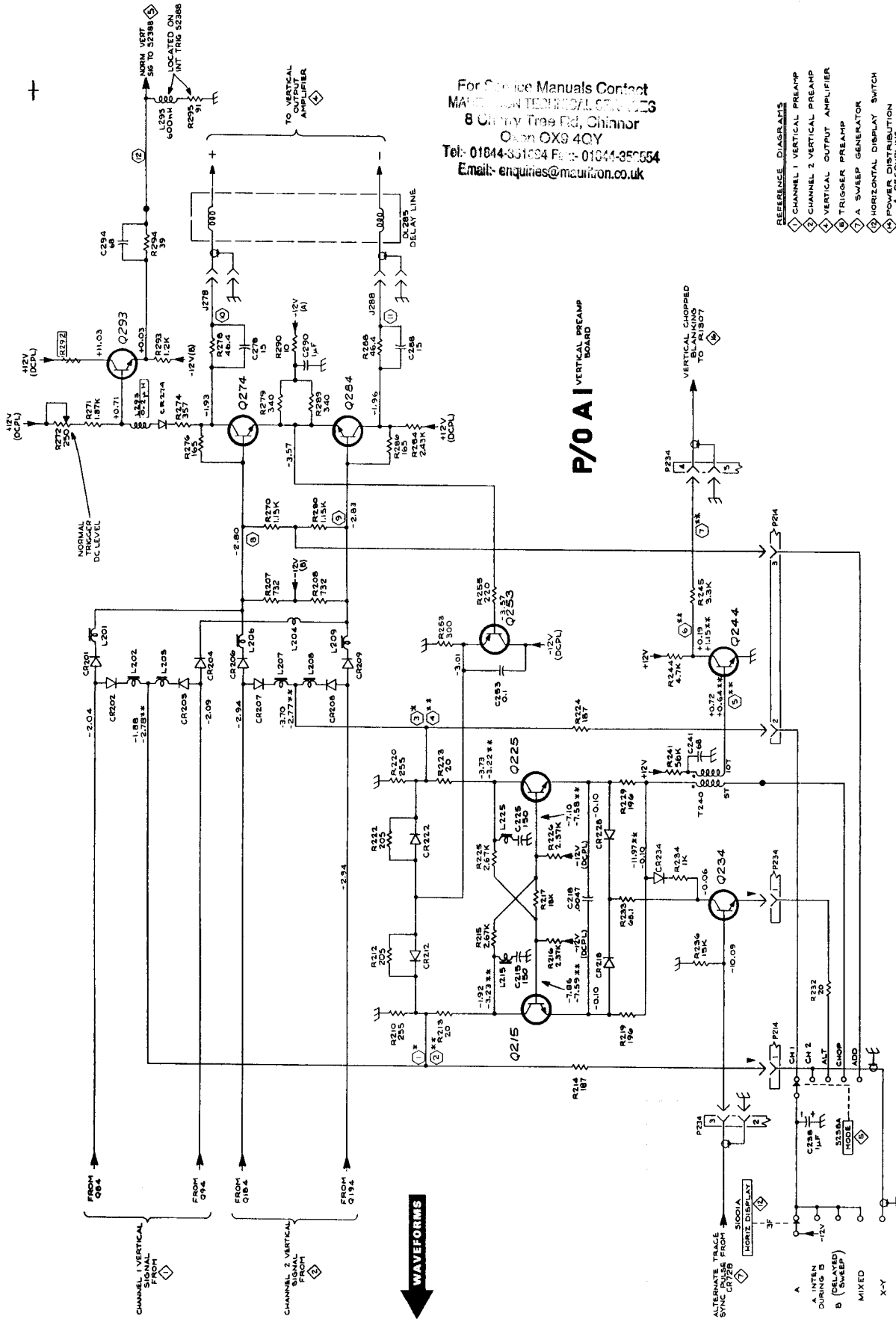

- REFERENCE DIAGRAMS
- ① CHANNEL 1 VERTICAL PREAMP
  - ② CHANNEL 2 VERTICAL PREAMP
  - ③ VERTICAL OUTPUT AMPLIFIER
  - ④ TRIGGER PREAMP
  - ⑤ A SWEEP GENERATOR
  - ⑥ HORIZONTAL DISPLAY SWITCH
  - ⑦ POWER DISTRIBUTION
  - ⑧ Z AXIS AMPLIFIER

SEE PARTS LIST FOR EARLIER VALUES AND SERIAL NUMBER VALUES OF PARTS MARKED WITH BLUE SQUARE

SEE PARTS LIST FOR SEMICONDUCTOR TYPES

VOLTAGES AND WAVEFORMS obtained under conditions given on page 512 except as follows:

MODE ..... ALT  
 \*MODE ..... CHOP



Fig. 8-5

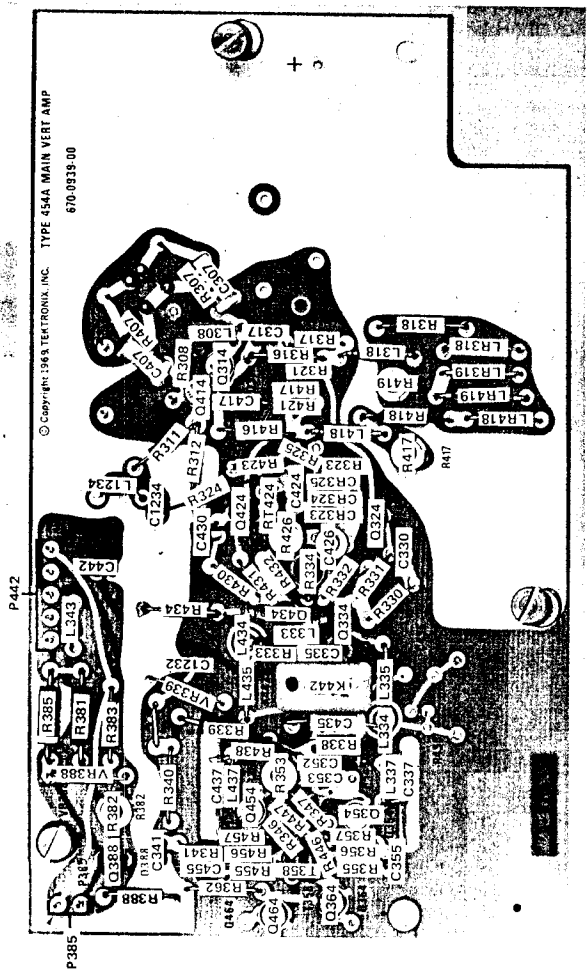

Fig. 8-4. Main Vertical Amplifier circuit board-A2.

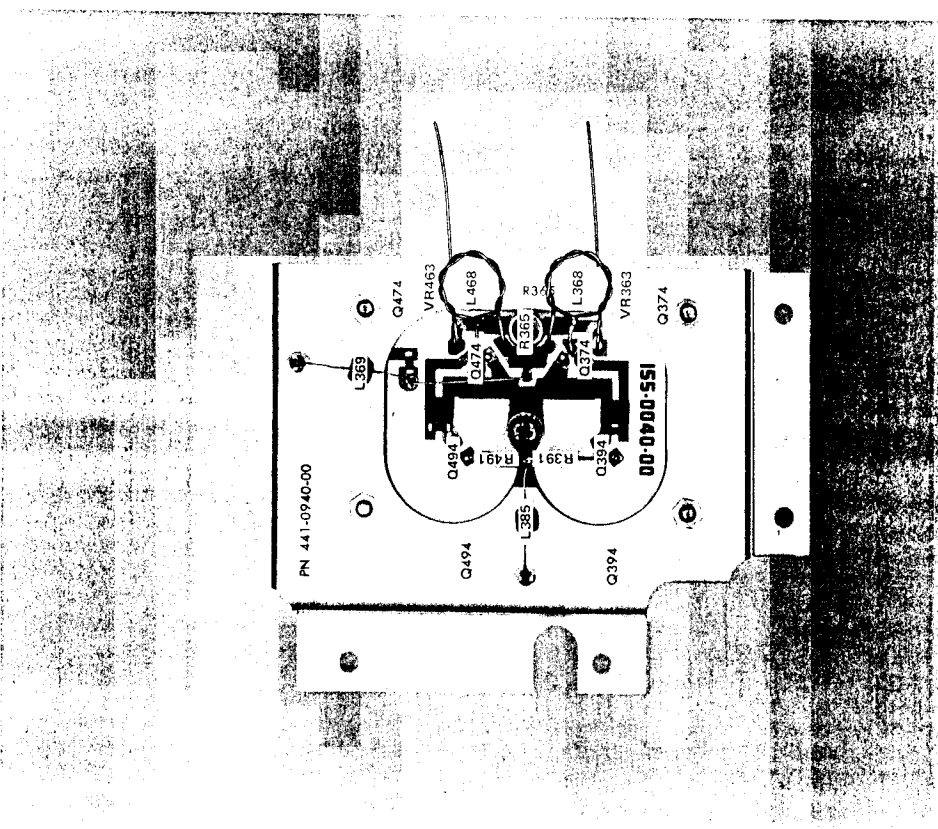
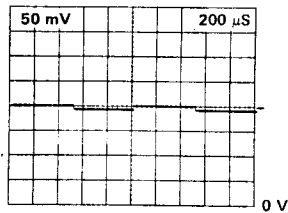
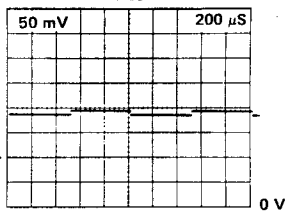

Fig. 8-5. Vertical Amplifier Thick Film Hybrid Circuit-A3.

1



2



3

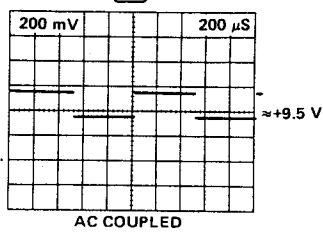

4

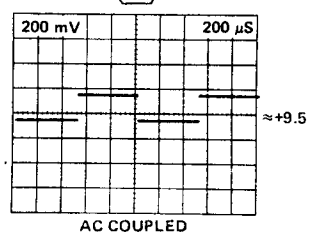

5

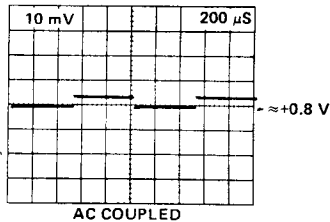

6

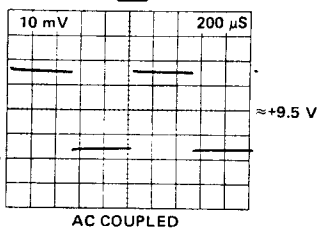

7

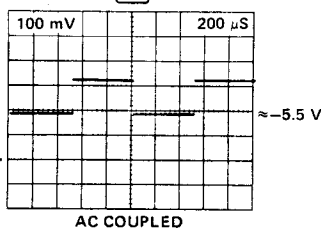

8

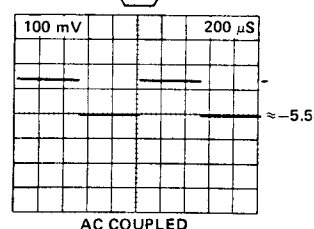

9

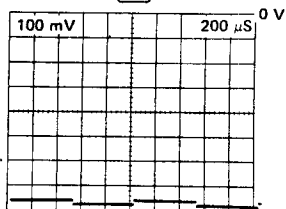

10\*

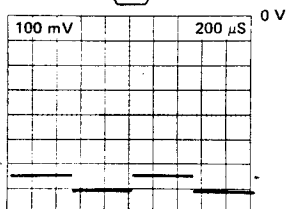

11

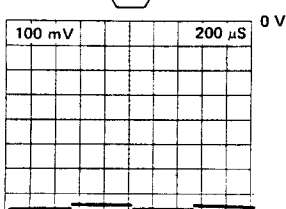

12\*

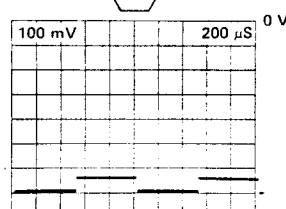

13

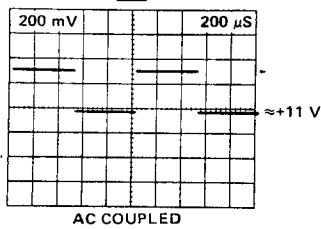

14\*

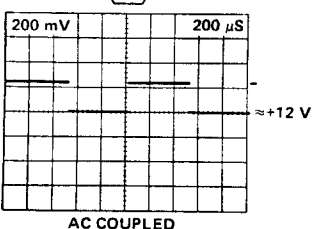

15

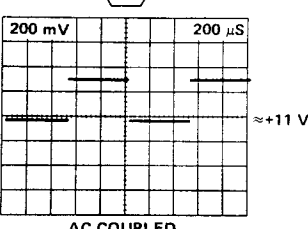

16\*

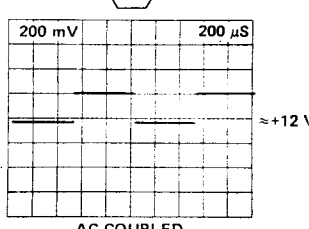

17

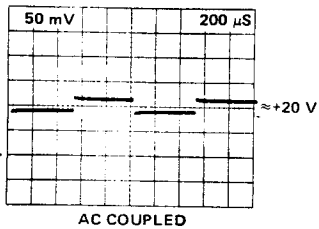

18\*

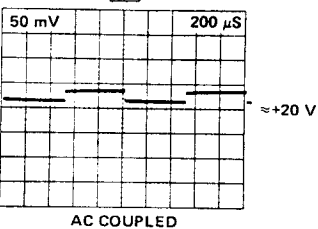

19

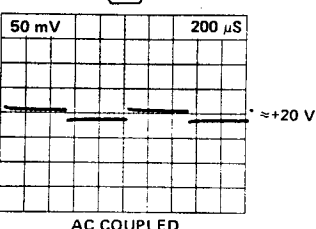

20\*

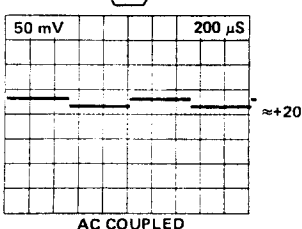

21

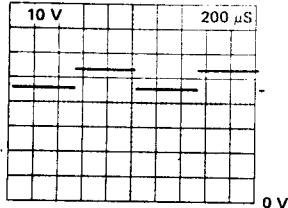

22\*

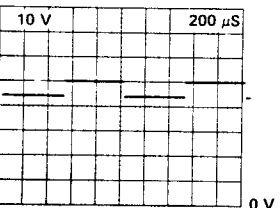

23

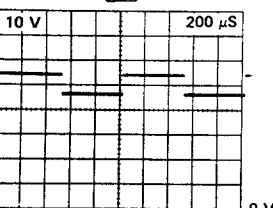

24\*

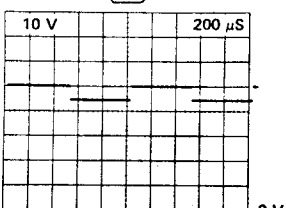

VERTICAL OUTPUT  
AMPLIFIER

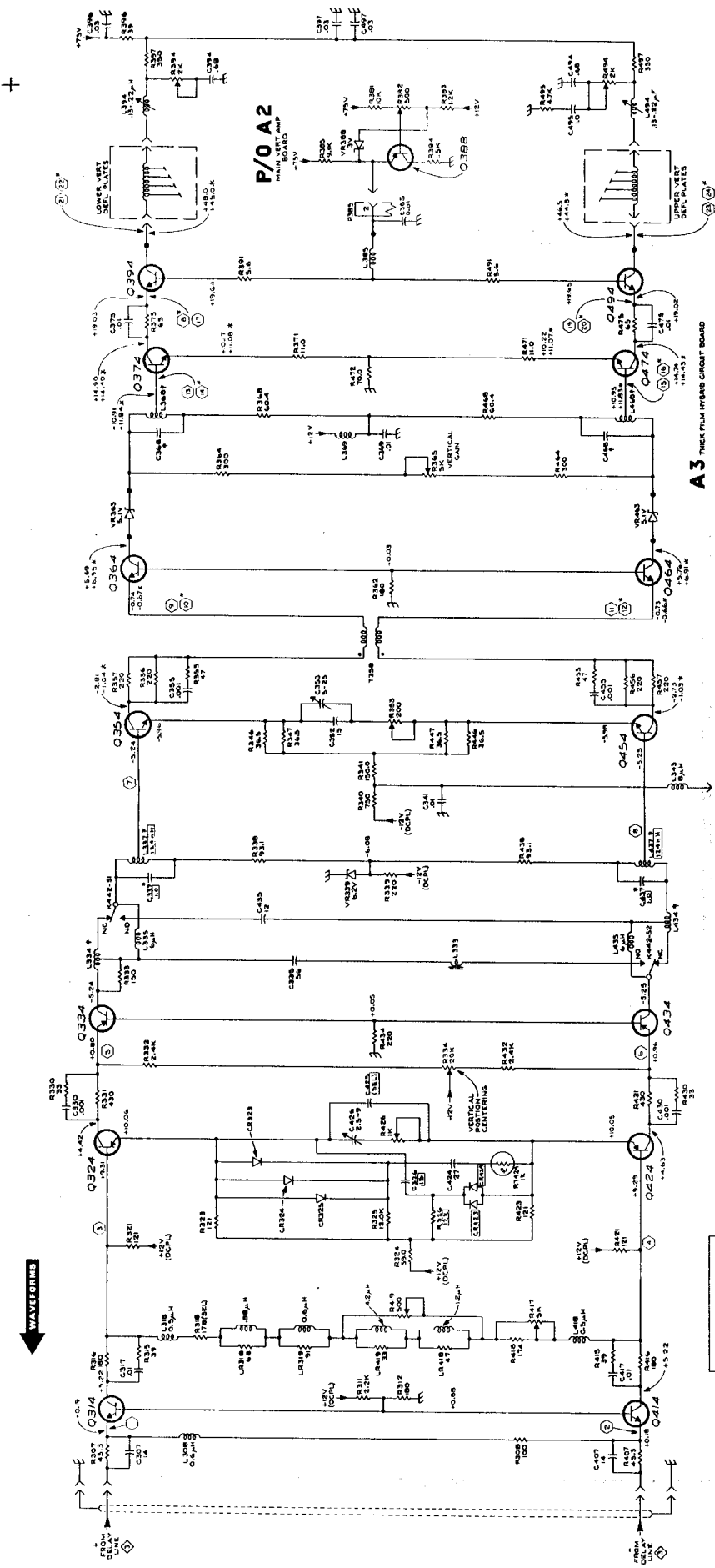

A3 THICK FILM HYBRID CIRCUIT BOARD

NOTES:  
1. SEE PARTS LIST FOR SEMICONDUCTOR TYPES  
2. COMPONENT PART OF CIRCUIT BOARD SHOWN ON DRAWING

REFERENCE DIAGRAM  
VERTICAL SWITCHING

SEE PARTS LIST FOR MAIN VERT AMP BOARD WHICH MAY VARY

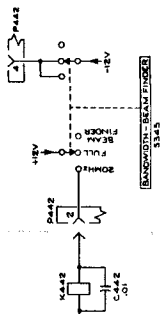

P/O A2 MAIN VERT AMP BOARD

SEE PARTS LIST FOR MAIN VERT AMP BOARD WHICH MAY VARY

VERTICAL OUTPUT AMPLIFIER

For Service Manuals Contact  
MANTON TECHNICAL SERVICES  
8 Cherry Tree Rd, Oxtford  
Oxon OX9 4CJY  
Tel: 01234-851894 Fax: 01234-852554  
Email: enquiries@mzontron.co.uk

454A OSCILLOSCOPE





1

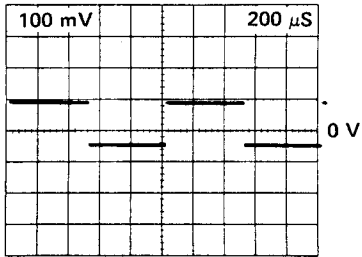

2

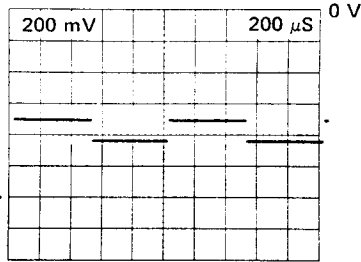

3

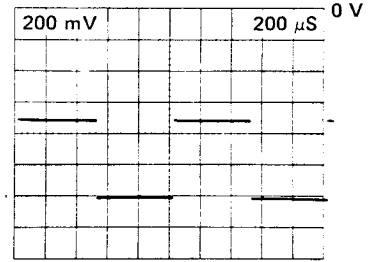

4

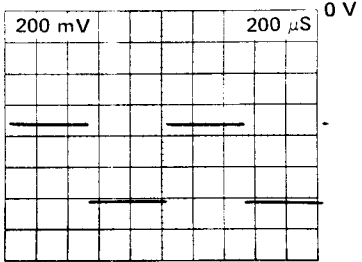

5

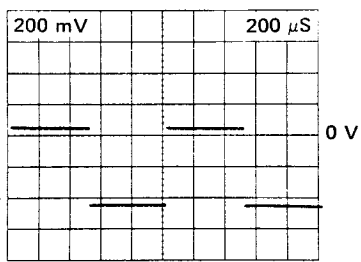

6

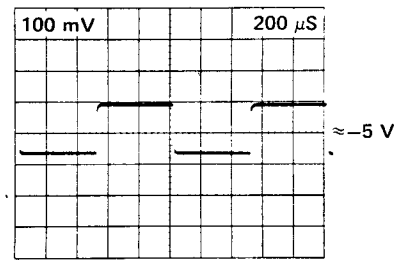

7

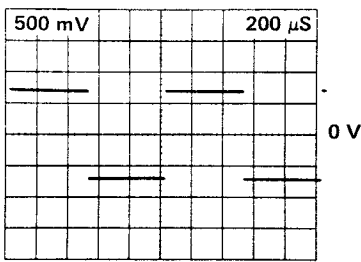

For Service Manuals Contact  
 MAURITRON TECHNICAL SERVICES  
 8 Cherry Tree Rd, Chinnor  
 Oxon OX9 4DY  
 Tel: 01844-351694 Fax: 01294-057364  
 Email: enquiries@mauritron.co.uk

WAVEFORMS

P/0 A1

VERTICAL PREAMP BOARD

P/0 A5

B SWEEP BOARD

P/0 A4

A SWEEP BOARD

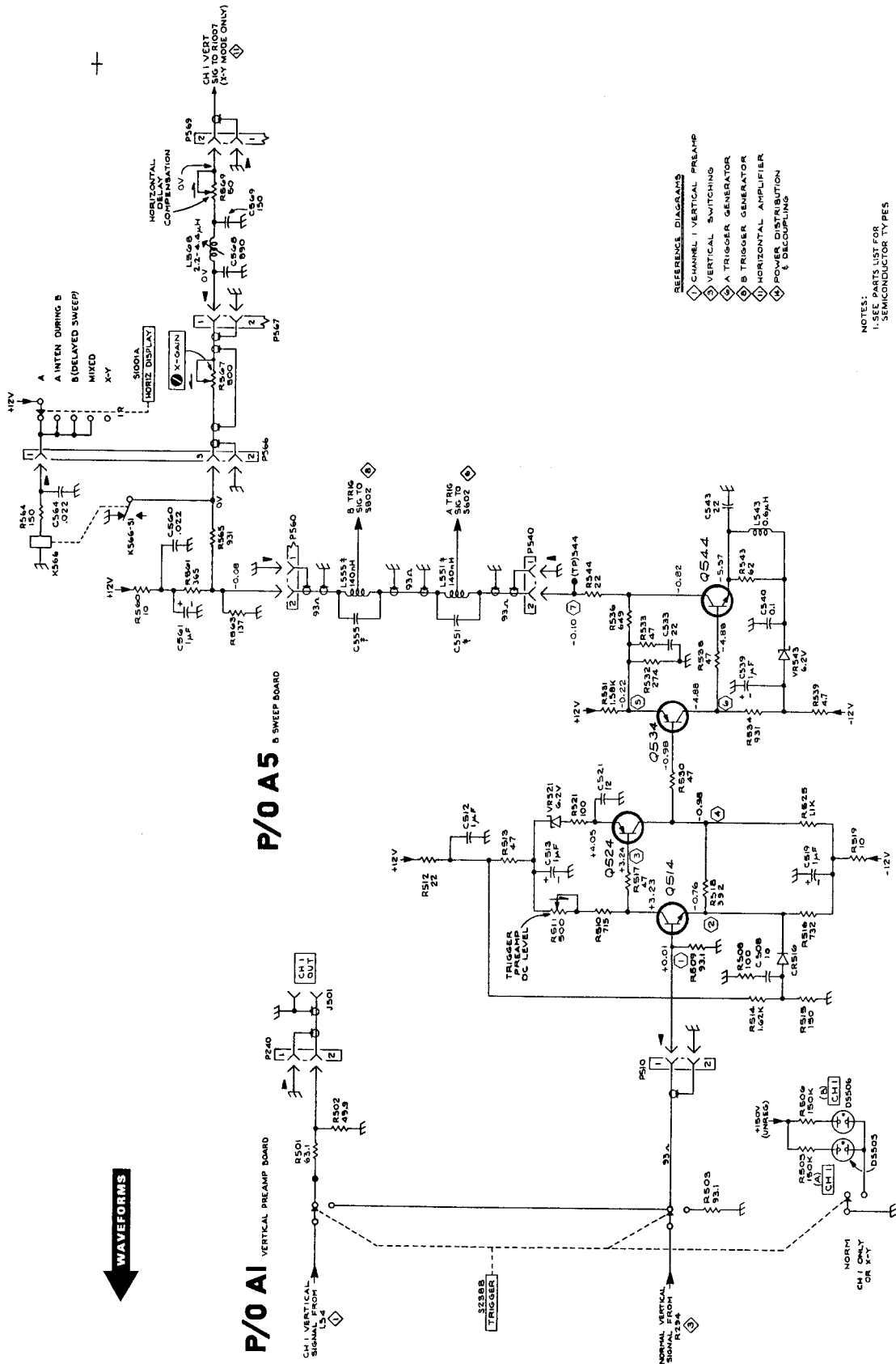

REFERENCE DIAGRAMS

- ① CHANNEL 1 VERTICAL PREAMP
- ② VERTICAL SWITCHING
- ③ A TRIGGER GENERATOR
- ④ B TRIGGER GENERATOR
- ⑤ HORIZONTAL AMPLIFIER
- ⑥ POWER DISTRIBUTION & DECOUPLING

NOTES:  
 1-SEE PARTS LIST FOR SEMICONDUCTOR TYPES  
 2-F COMPONENT IS INTEGRAL PART OF CHANNEL 1 BOARD AND IS MOUNTED ON 9A02 AND 155 IS MOUNTED ON 9B02

P/0 A4

A SWEEP BOARD

VOLTAGES and WAVEFORMS obtained under conditions given on page 8-2.

454A OSCILLOSCOPE

TRIGGER PREAMP

0471

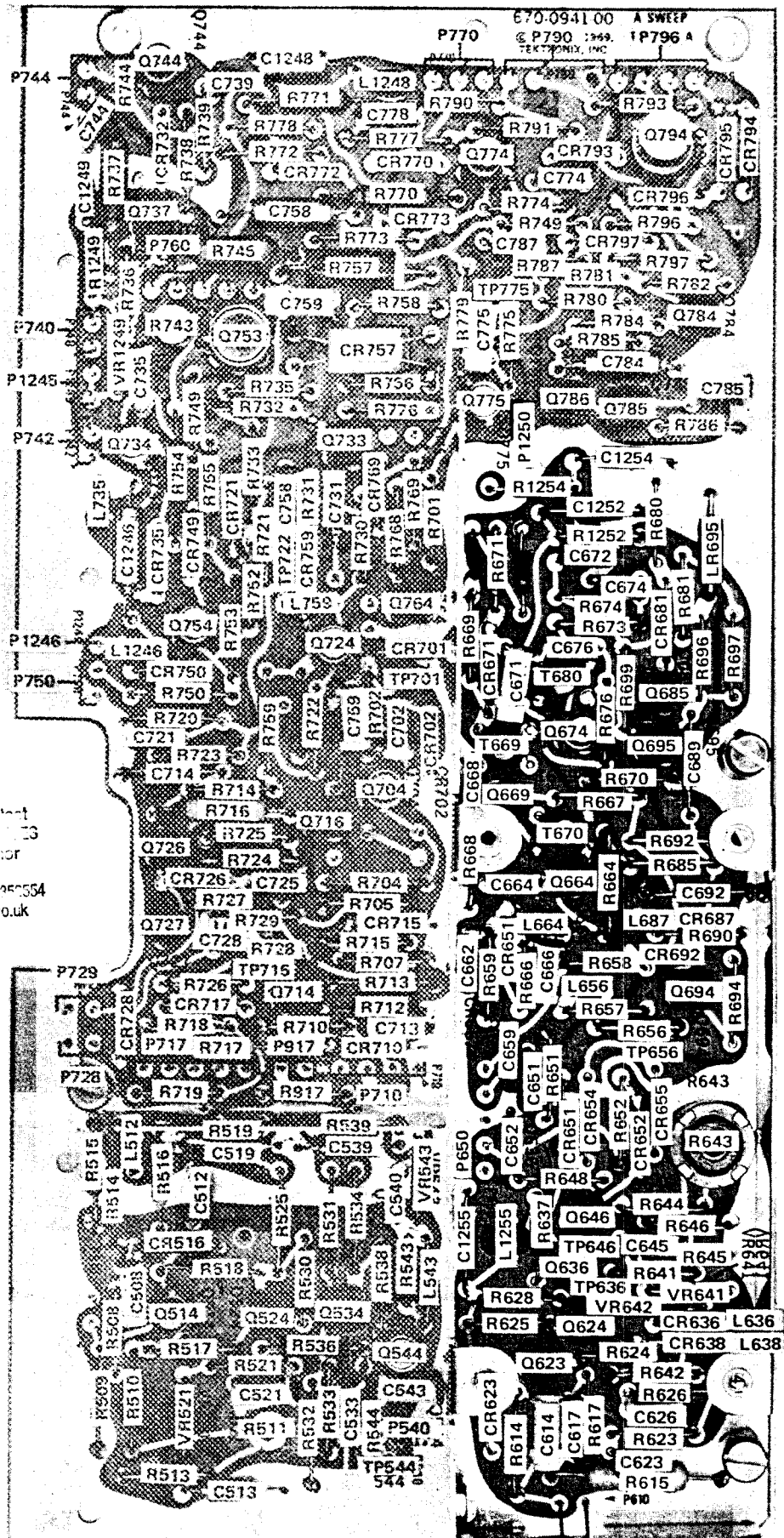

For Service Manuals Contact  
 MAURITRON TECHNICAL SERVICES  
 8 Cherry Tree Lane  
 Oxon OX1 1PH  
 Tel: 01844-351634 Fax: 01844-355554  
 Email: enquiries@mauritron.co.uk

Fig. 8-8. Partial A Sweep circuit board—P/O A4. A Trigger Generator circuit shown.

1

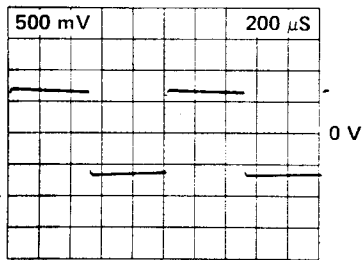

2

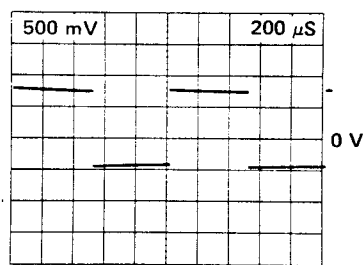

3

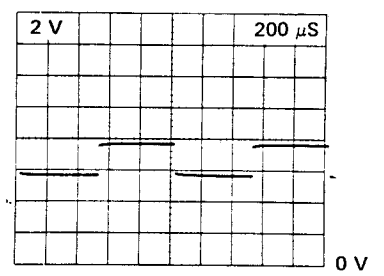

4

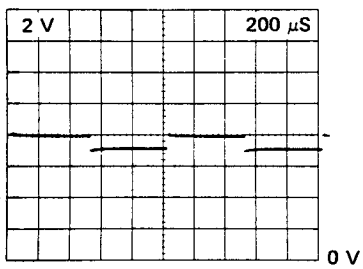

5

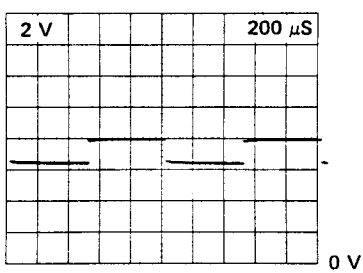

6

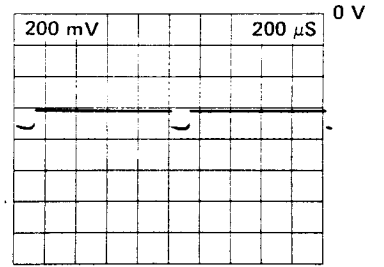

7

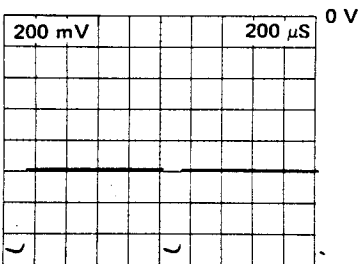

8

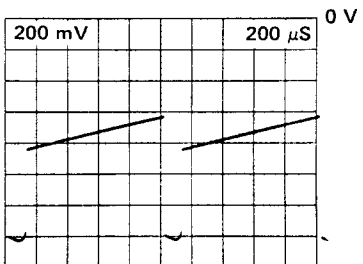

9

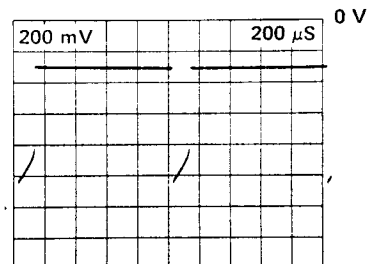

10

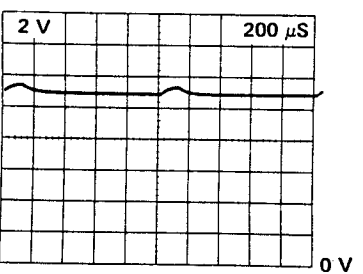

11

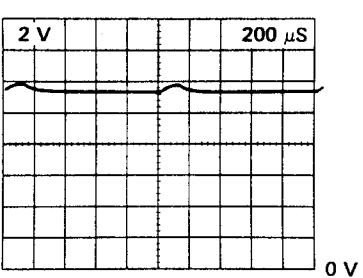

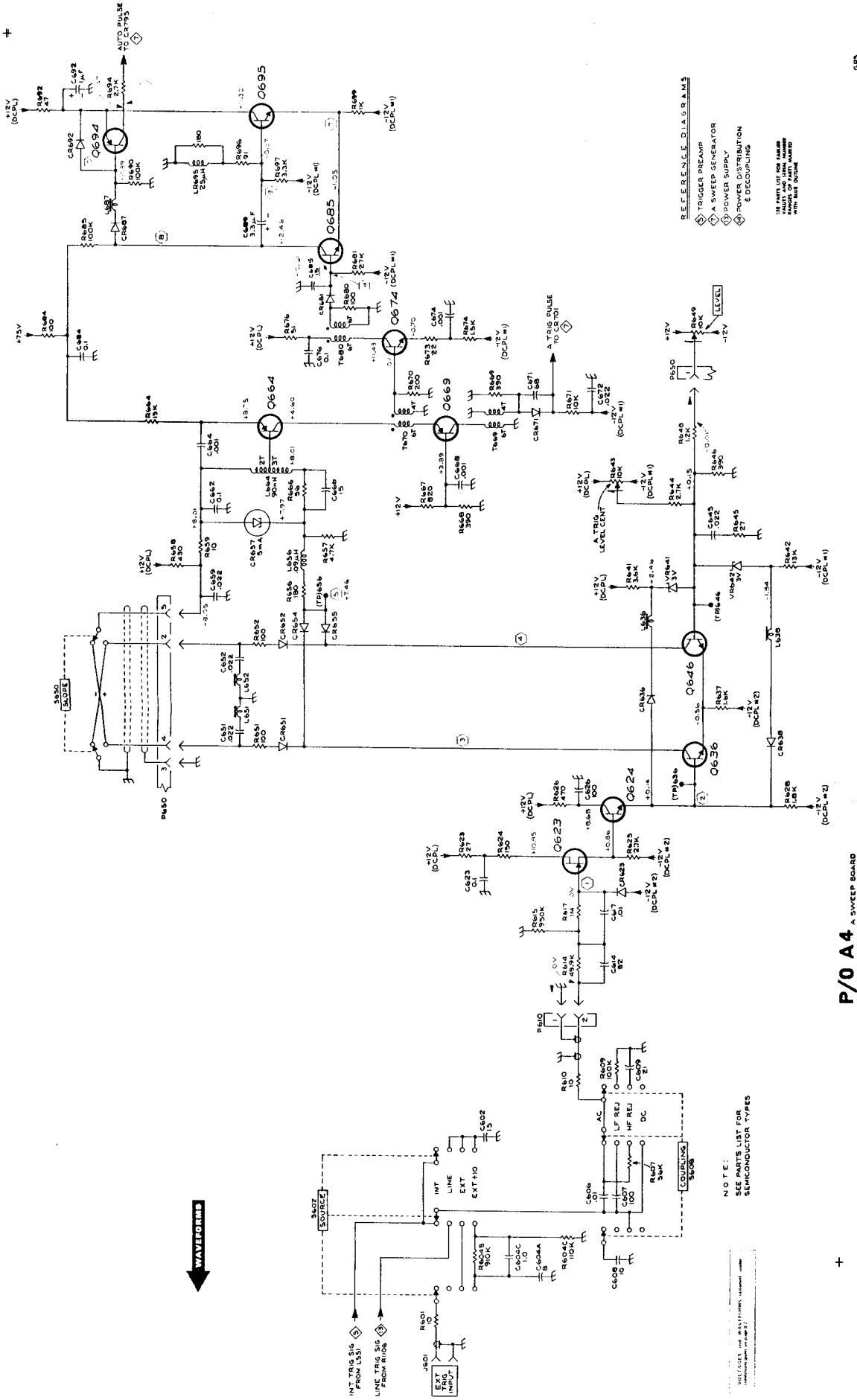

- SEE REFERENCE DIAGRAMS
- ⊕ TRIGGER PREAMP
  - ⊕ A SWEEP GENERATOR
  - ⊕ POWER SUPPLY
  - ⊕ POWER DISTRIBUTION
  - ⊕ DECOUPLING

NOTE: SEE PARTS LIST FOR SEMICONDUCTOR TYPES

454A OSCILLOSCOPE

P/O A4 A SWEEP BOARD

454A OSCILLOSCOPE

+

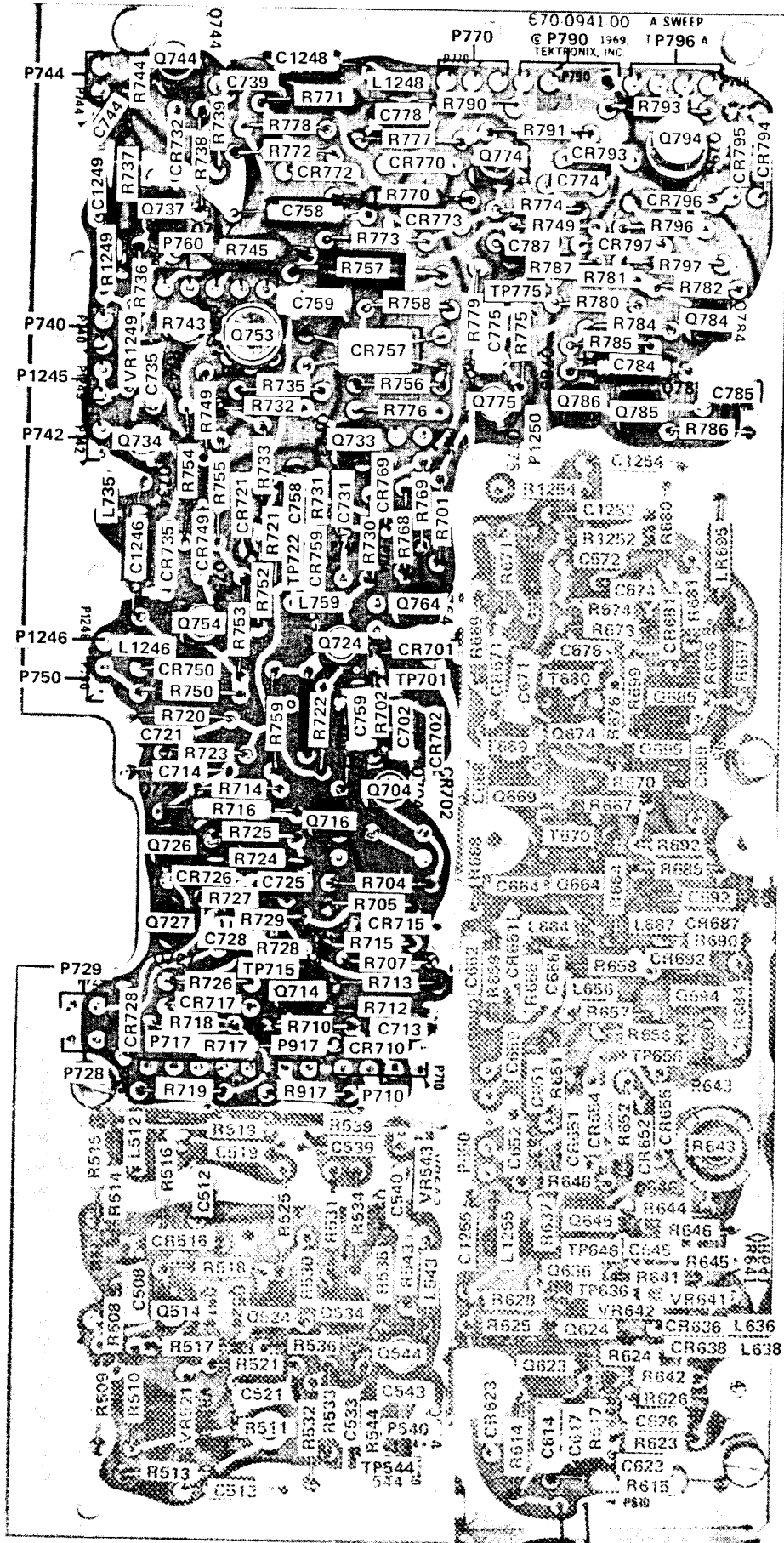

For Service Manuals Contact  
 MAURITRON TECHNOLOGIES  
 8 Cherry Tree Lane  
 Oxon, Bucks HP8 4NR  
 Tel: 01044-551741 FAX: 01044-551754  
 Email: enquiries@mauritron.co.uk

Fig. 8-9. Partial A Sweep circuit board—P/O A4. A Sweep Generator circuit shown.

1

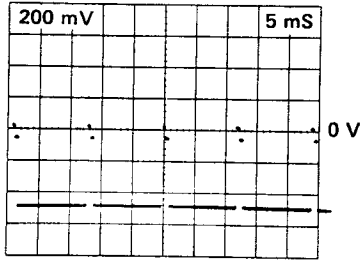

2

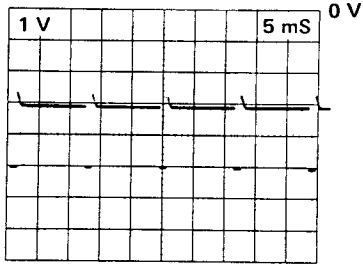

3

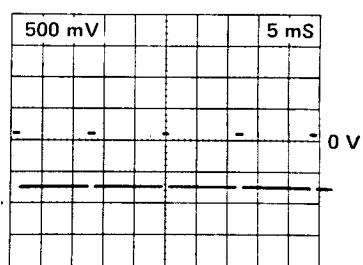

4

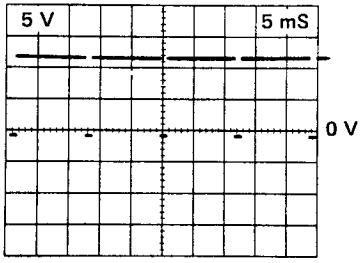

5

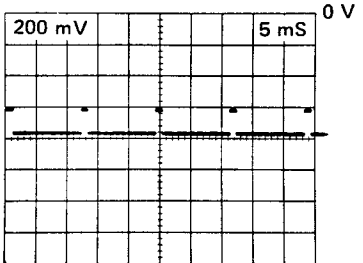

6

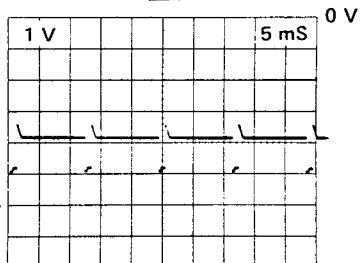

7

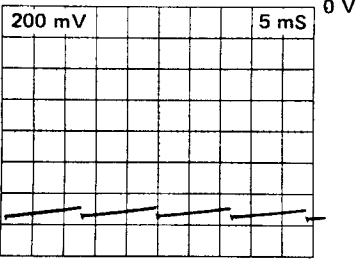

8

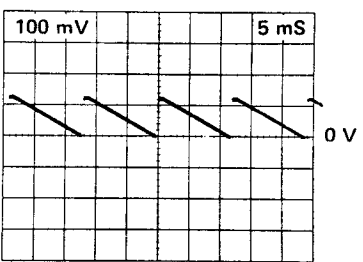

9

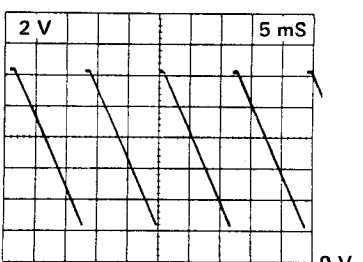

10

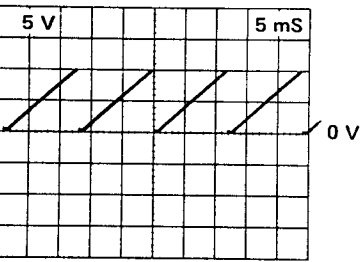

11

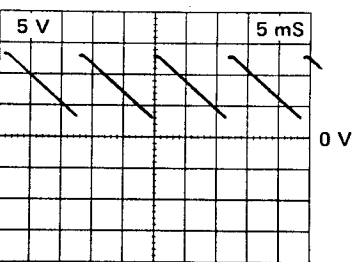

12

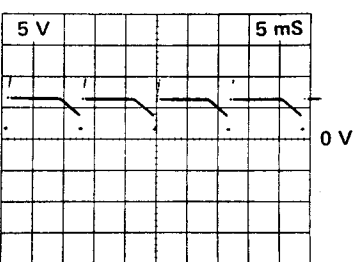

13

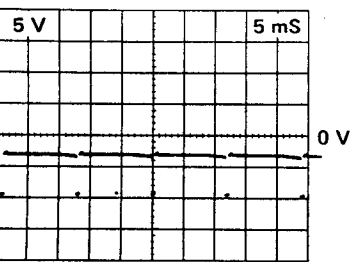

14

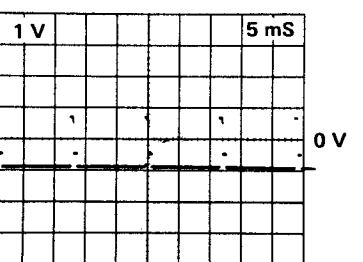

15

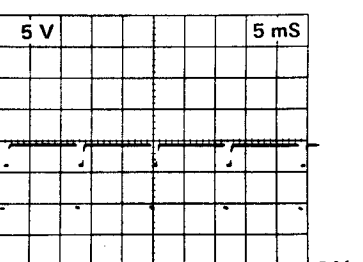



- REFERENCE DIAGRAMS
- ① VERTICAL SWITCHING
  - ② A TRIGGER GENERATOR
  - ③ A SWEEP GENERATOR
  - ④ A & B TRIGGER SWITCH
  - ⑤ HORIZONTAL DISPLAY SWITCH
  - ⑥ HORIZONTAL DISPLAY SWITCHING
  - ⑦ POWER DISTRIBUTION & DECOUPLING

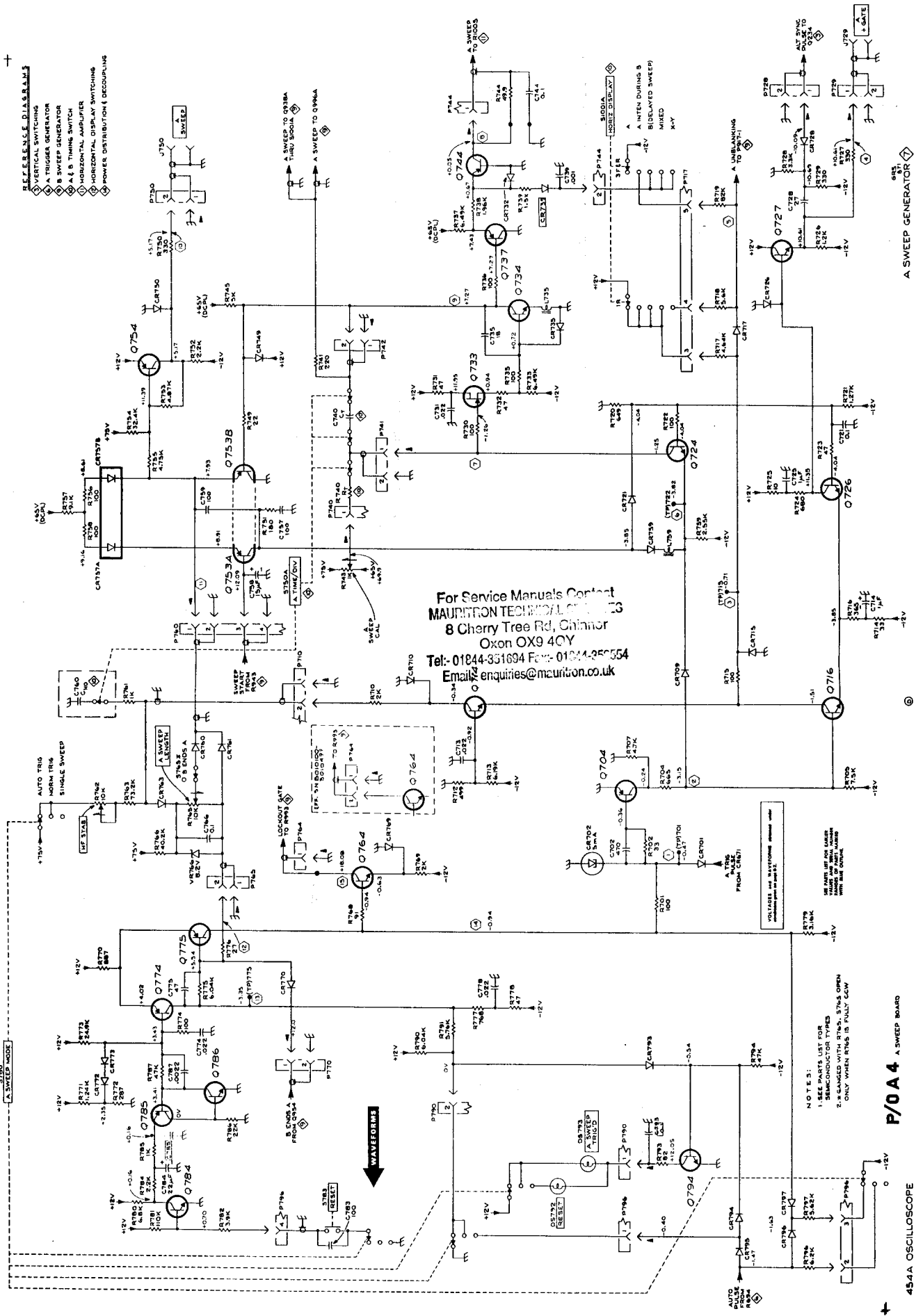

For Service Manuals Contact  
**MAURINTON TECHNICAL SERVICES**  
 8 Cherry Tree Rd, Chinnor  
 Oxon OX9 4QY  
 Tel: 01844-351694 Fax: 01844-350554  
 Email: enquiries@maurinton.co.uk

NOTE 5:  
 1. SEE PARTS LIST FOR SEMICONDUCTOR TYPES  
 2. \* CHANGED WITH R765, S765 OPEN ONLY WHEN R765 IS FULLY CLOSED

P/O 4 A SWEEP BOARD

454A OSCILLOSCOPE

A SWEEP GENERATOR

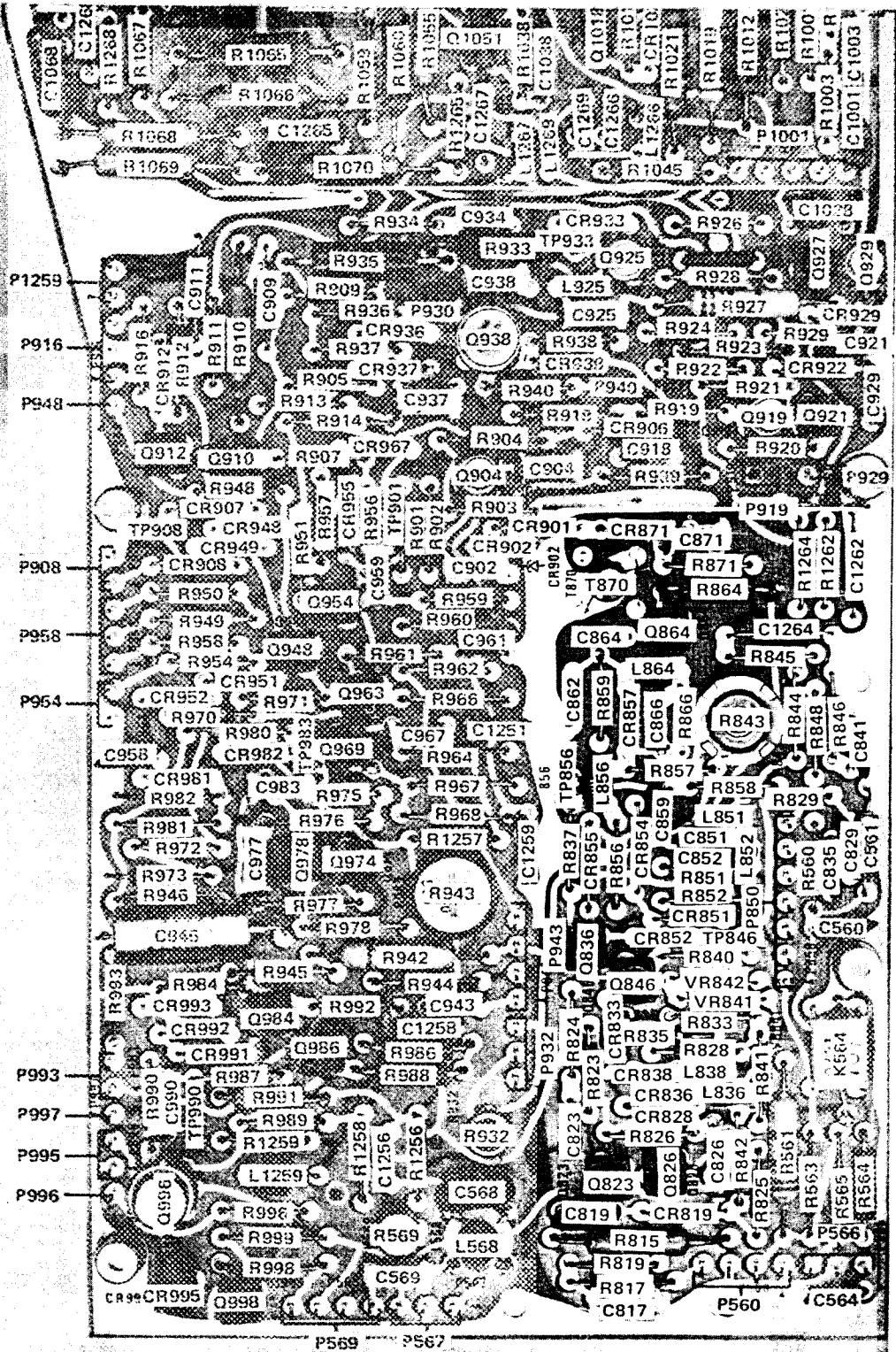
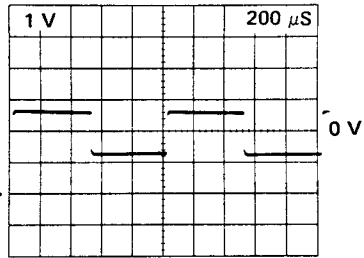
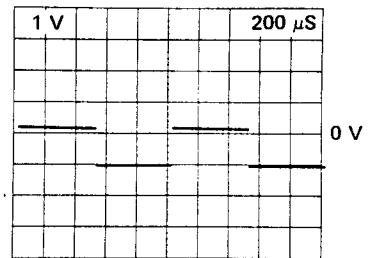

Fig. 8-10. Partial B Sweep circuit board—P/O A5. B Trigger Generator circuit shown.

1



2



3

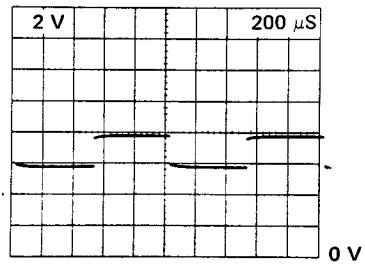

4

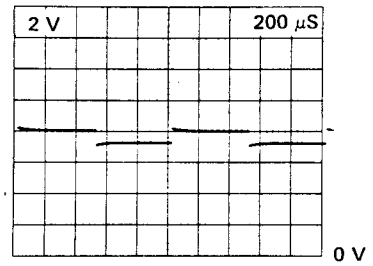

5

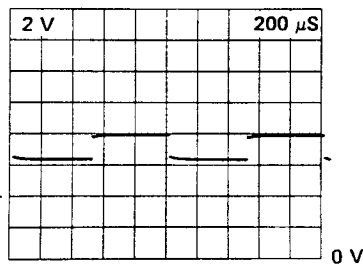

WAVEFORMS

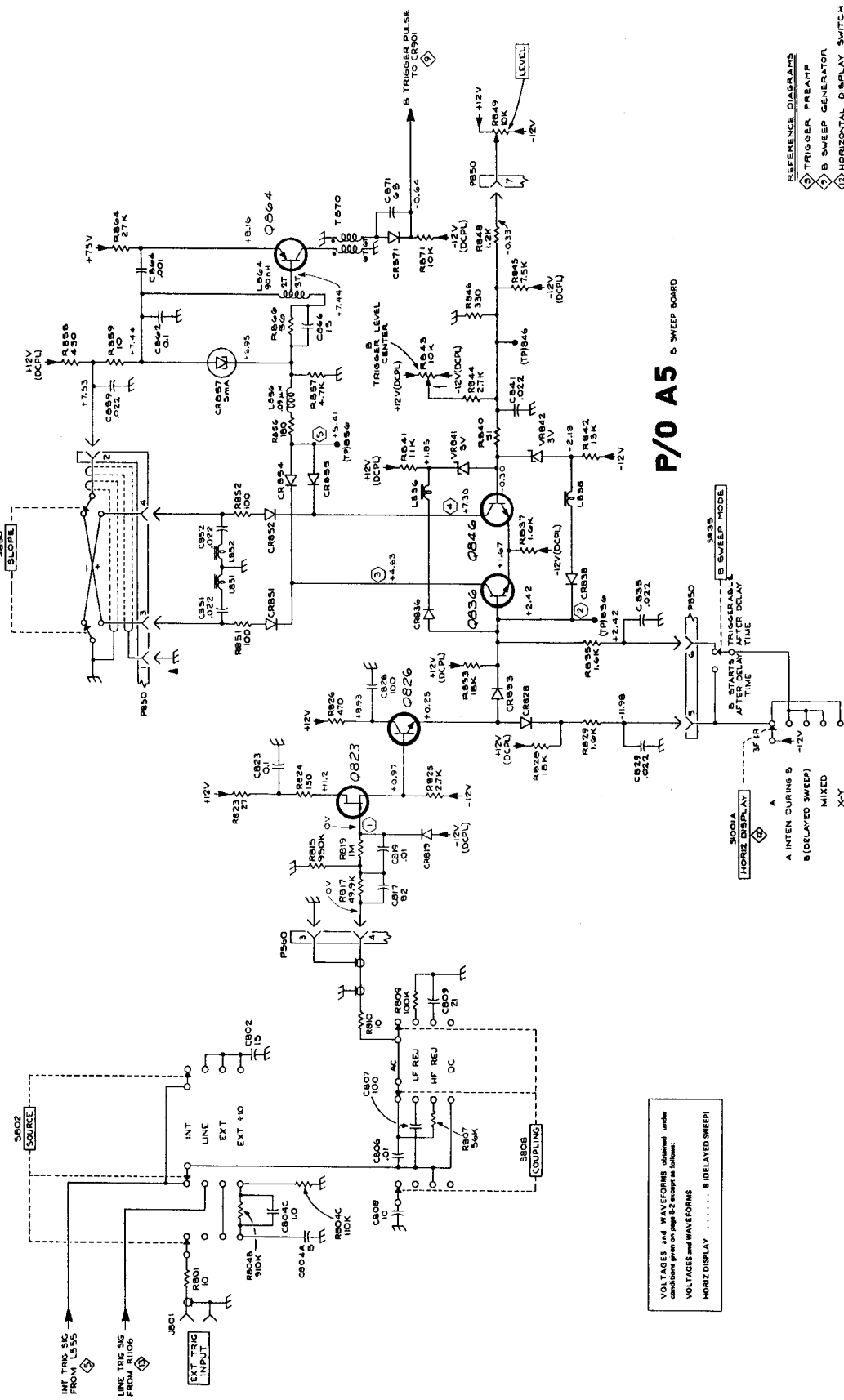

VOLTAGES and WAVEFORMS obtained under conditions given on page 52 except as follows:  
 VOLTAGES and WAVEFORMS  
 HORIZ DISPLAY ..... 8 (DELAYED SWEEP)

P/O A5 B SWEEP BOARD

- REFERENCE DIAGRAMS
- ① TRIGGER PREAMP
  - ② B SWEEP GENERATOR
  - ③ HORIZONTAL DISPLAY SWITCH
  - ④ POWER SUPPLY
  - ⑤ DECOUPLING

NOTE:  
 SEE PARTS LIST FOR SEMICONDUCTOR TYPES

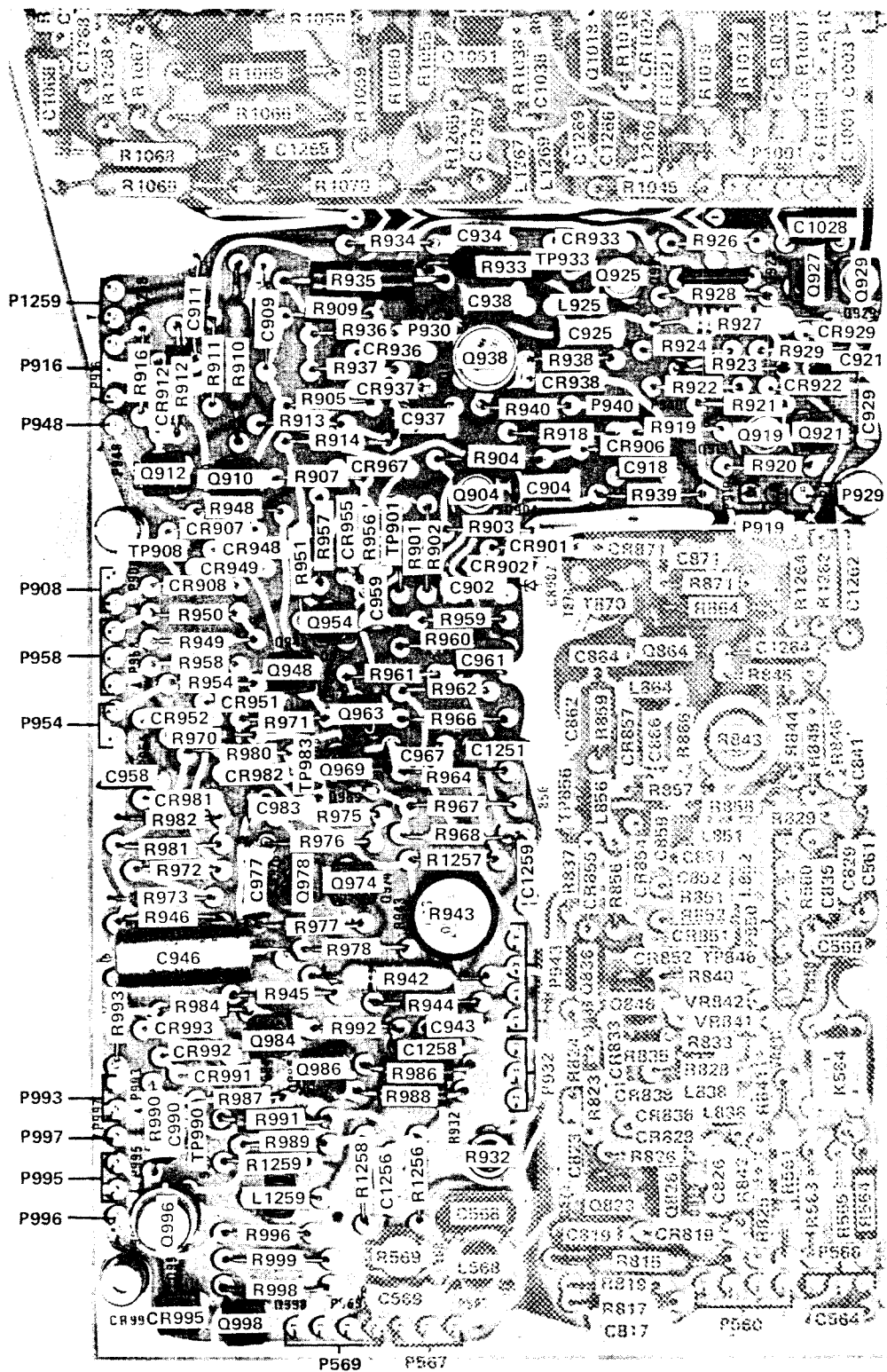
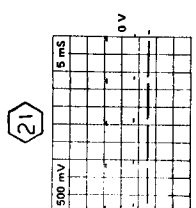
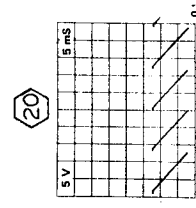
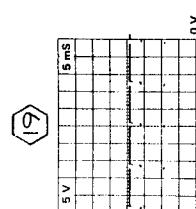
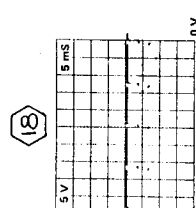
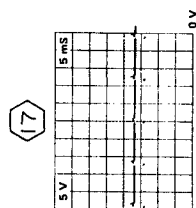
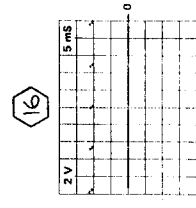
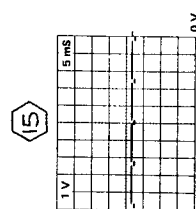
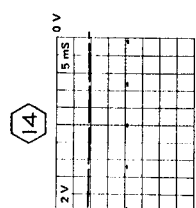
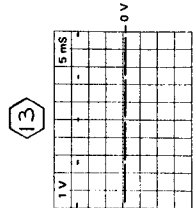
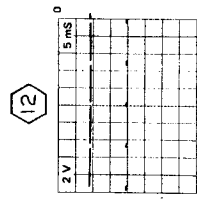
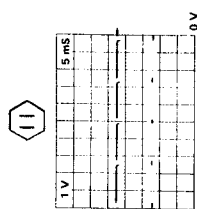
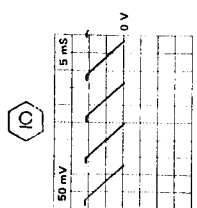
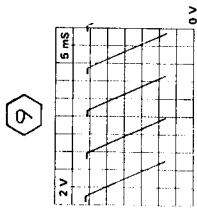
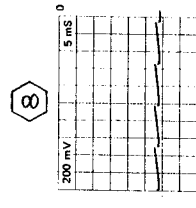
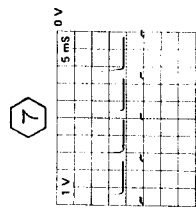
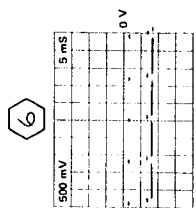
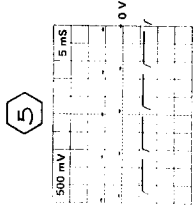
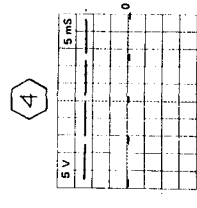
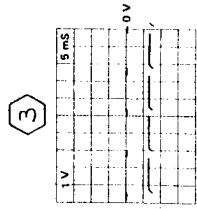
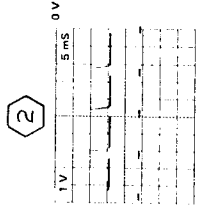
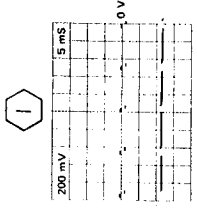

Fig. 8-11. Partial B Sweep circuit board—P/O A5. B Sweep Generator circuit shown.

For Service Manuals Contact  
 MAURIFRON TECHNICAL SERVICES  
 8 Cherry Tree Lane  
 Oxon OX1 1JH  
 Tel: 01044-351004  
 Email: enquiries@maurifron.co.uk





For Service Manuals Contact  
**MAURIFRON TECHNICAL SERVICES**  
 8 Cherry Tree Rd, Chalfont  
 Oxon OX9 4CY  
 Tel: 01244-351834 Fax: 01244-355354  
 Email: enquiries@maurifron.co.uk

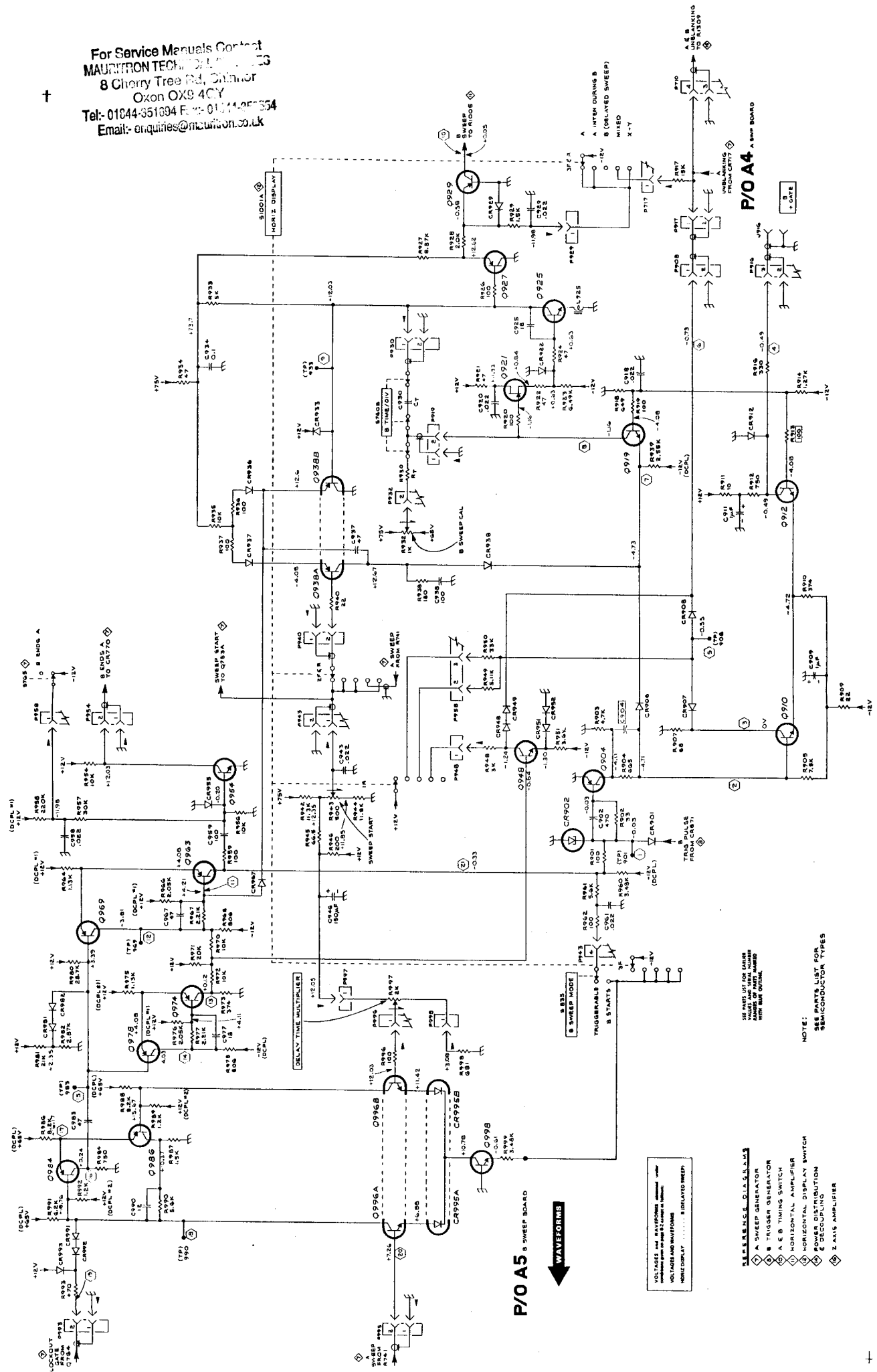

**P/O A5** B SWEEP BOARD  
 WAVEFORMS

- SEE REFERENCE DIAGRAMS
- ① A SWEEP GENERATOR
  - ② B SWEEP GENERATOR
  - ③ A & B TIMING SWITCH
  - ④ HORIZONTAL AMPLIFIER
  - ⑤ HORIZONTAL DISPLAY SWITCH
  - ⑥ POSITION DISTRIBUTION
  - ⑦ Z AXIS AMPLIFIER

UNLESS OTHERWISE SPECIFIED  
 ALL RESISTORS ARE IN OHMS  
 CAPACITORS ARE IN P.F.  
 VOLTAGES AND WAVEFORMS  
 ARE INDICATED AT THE POINTS  
 SHOWN

NOTE:  
 SEE PARTS LIST FOR  
 SUBSTITUTION TYPES

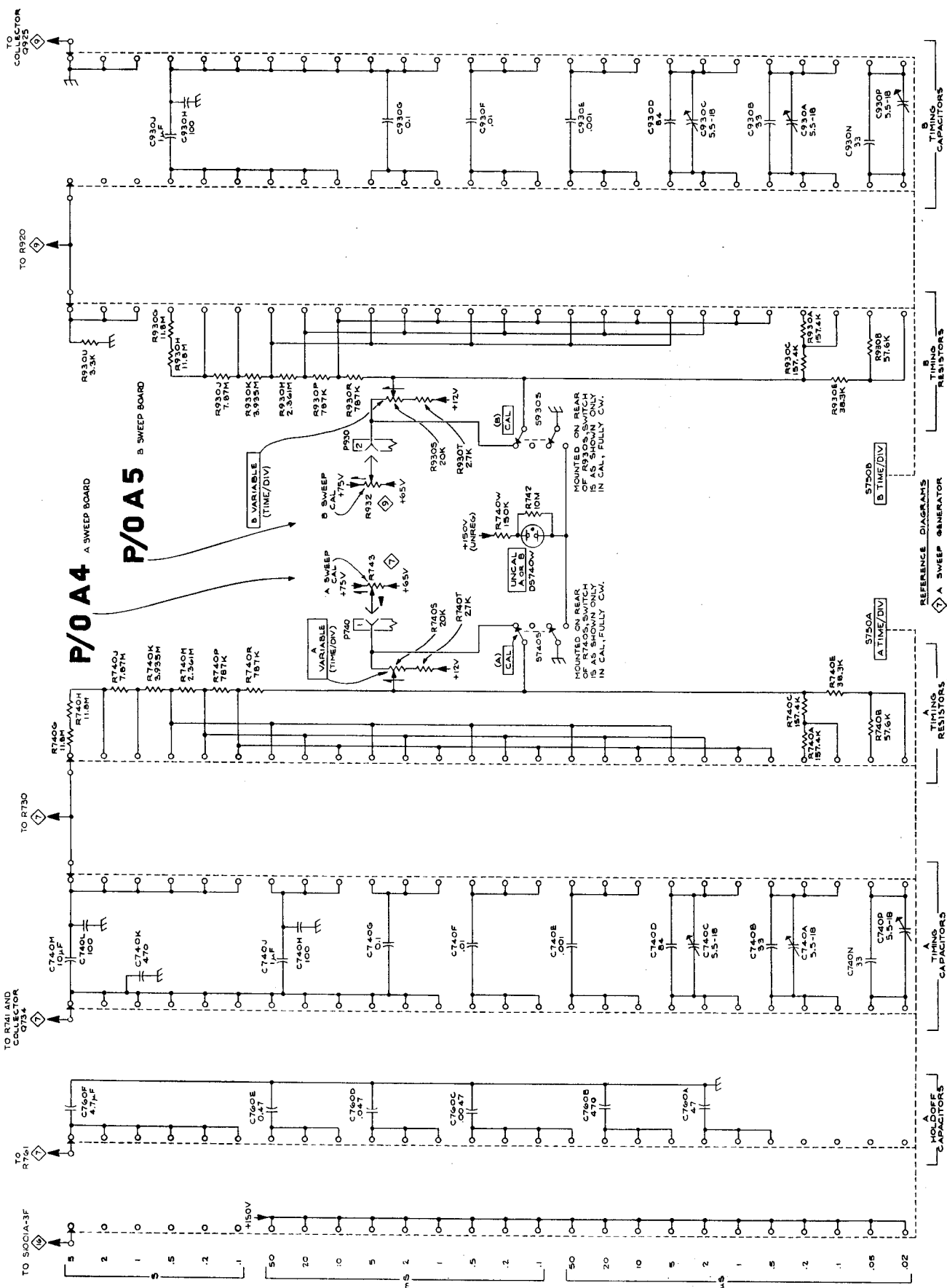



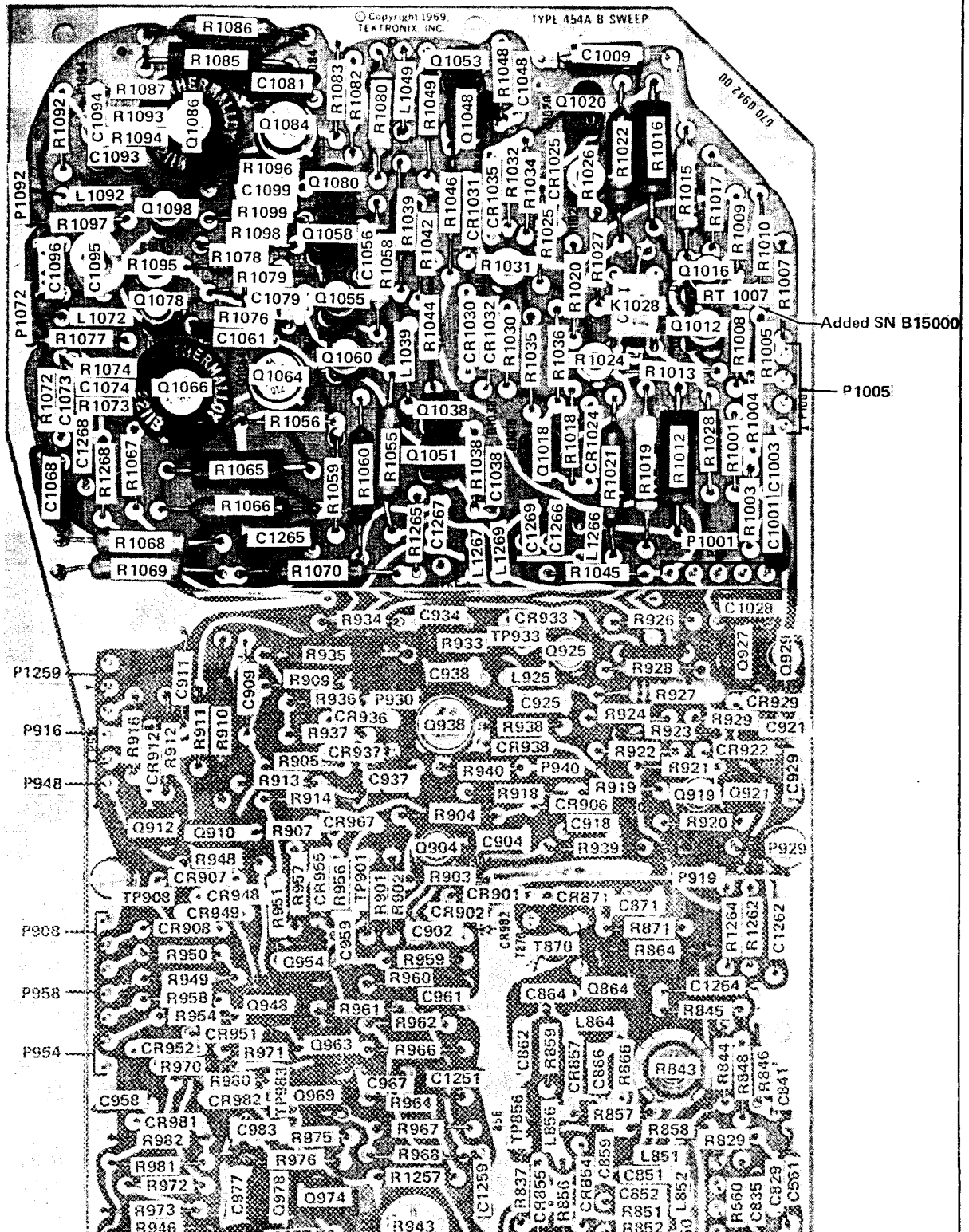
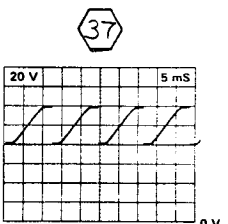
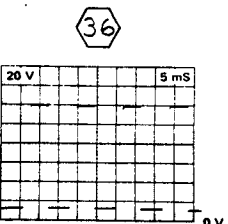
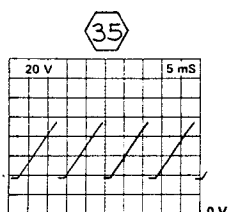
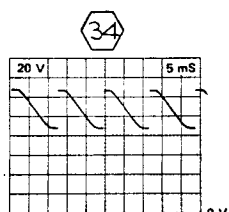
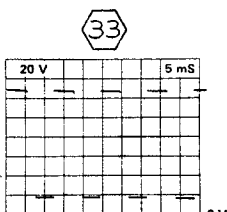
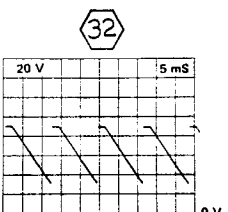
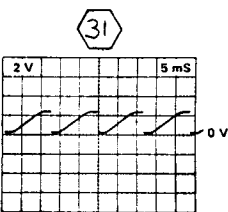
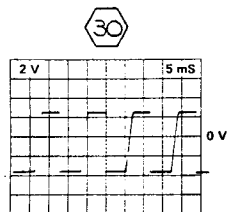
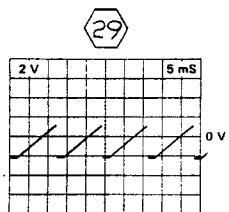
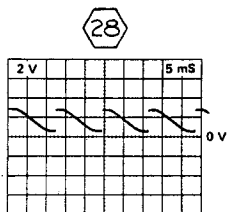
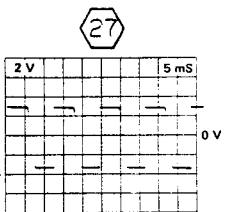
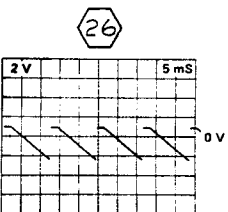
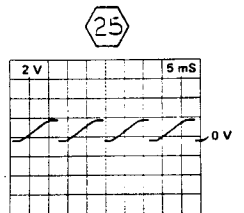
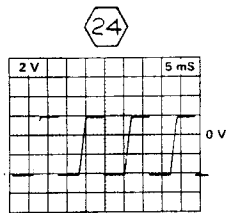
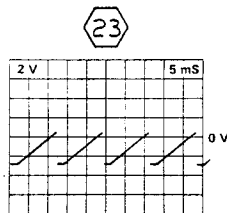
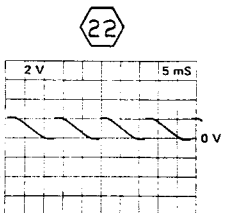
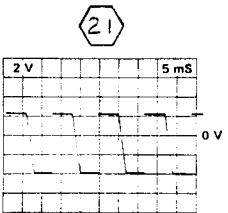
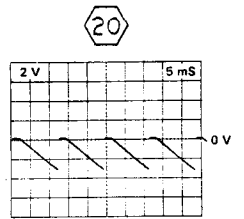
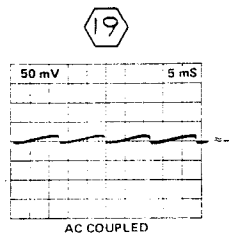
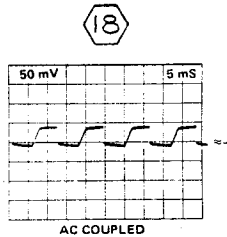
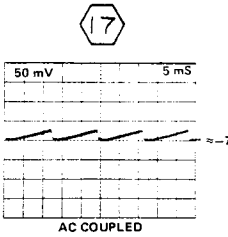
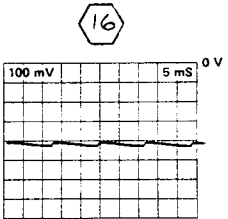
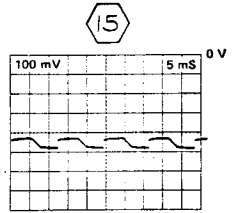
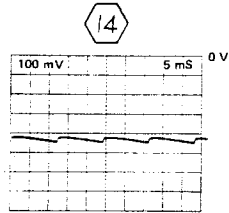
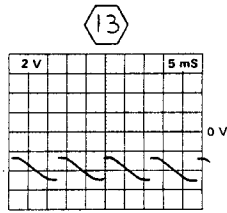
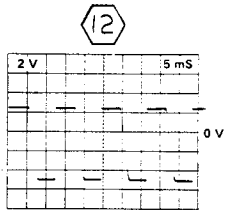
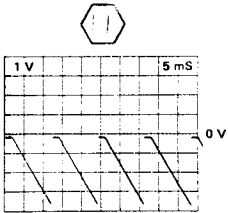
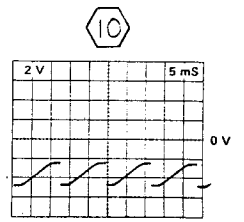
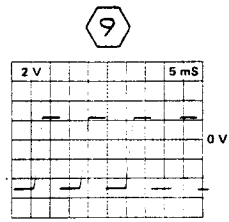
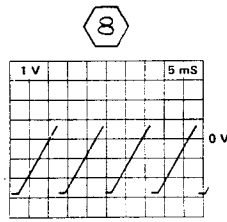
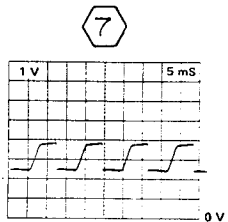
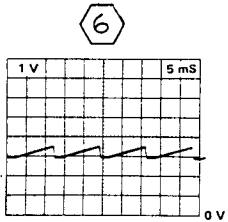
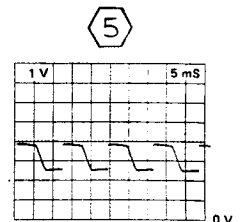
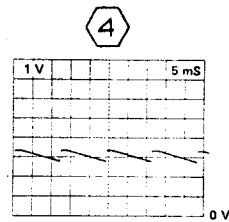
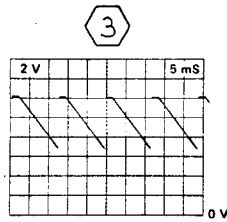
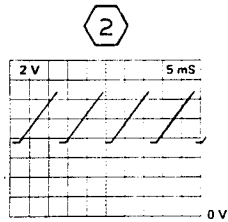
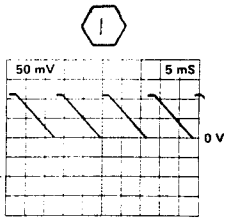
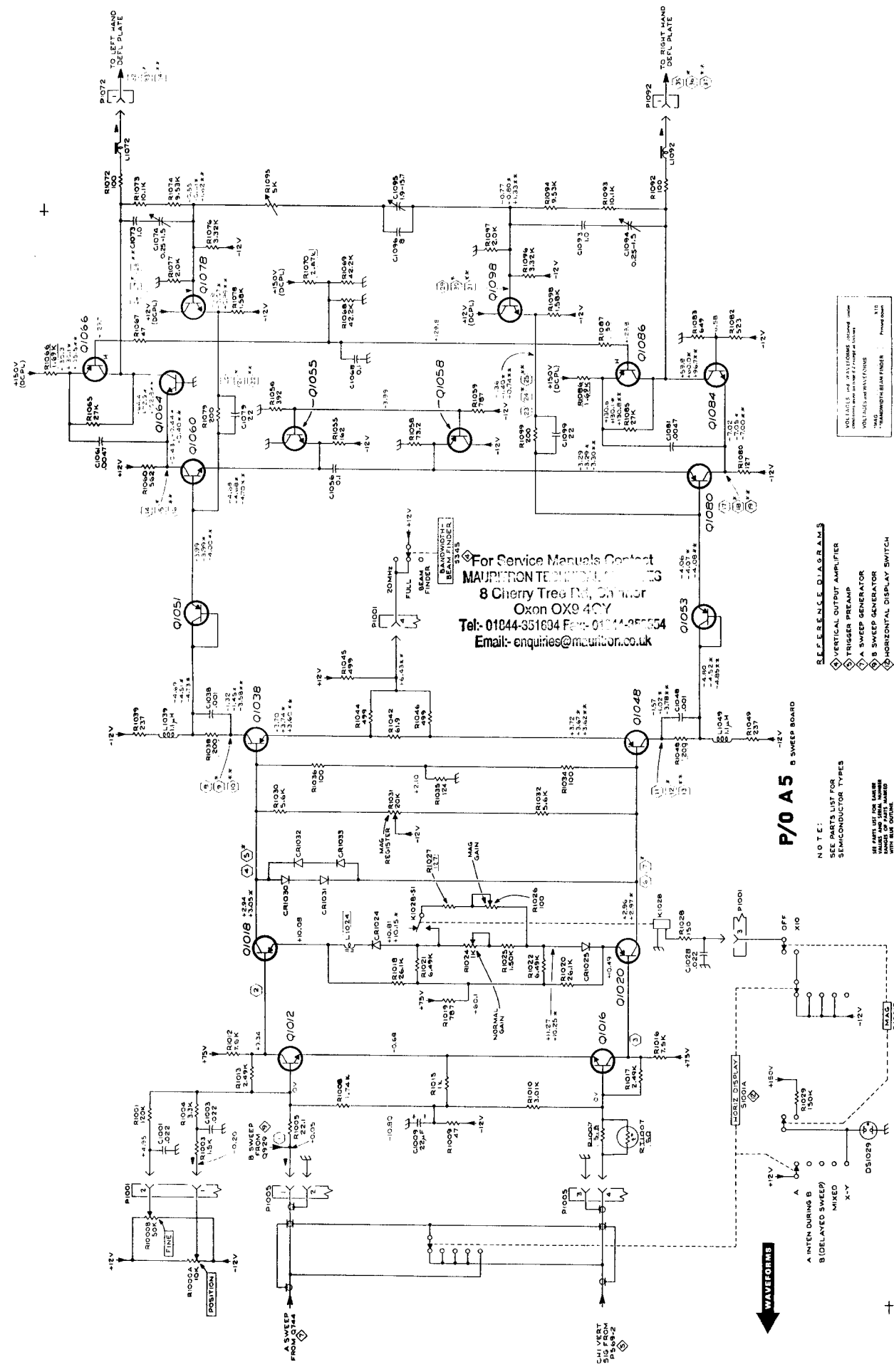

Fig. 8-12. Partial B Sweep circuit board—P/O A5. Horizontal Amplifier circuit shown.





For Service Manuals Contact  
**MAURITRON TECHNICAL SERVICES LTD**  
 8 Cherry Tree Rd, Oxon OX9 4QY  
 Tel: 01844-351634 Fax: 01844-351654  
 Email: enquiries@mauritron.co.uk

- REFERENCE DIAGRAMS**
- ◇ VERTICAL OUTPUT AMPLIFIER
  - ◇ TRIGGER PREAMP
  - ◇ A SWEEP GENERATOR
  - ◇ B SWEEP GENERATOR
  - ◇ HORIZONTAL DISPLAY SWITCH
  - ◇ POWER DISTRIBUTION & DECOUPLING

**NOTE:**  
 SEE PARTS LIST FOR  
 SEMICONDUCTOR TYPES

SEE PARTS LIST FOR VALUES  
 IN HANDS OF PARTS MANAGER  
 WITH BLUE OUTLINE

**P/O A5 B SWEEP BOARD**

**WAVEFORMS**

- INTERLOCKING B
- B (DELAYED SWEEP)
- MIXED
- X-Y

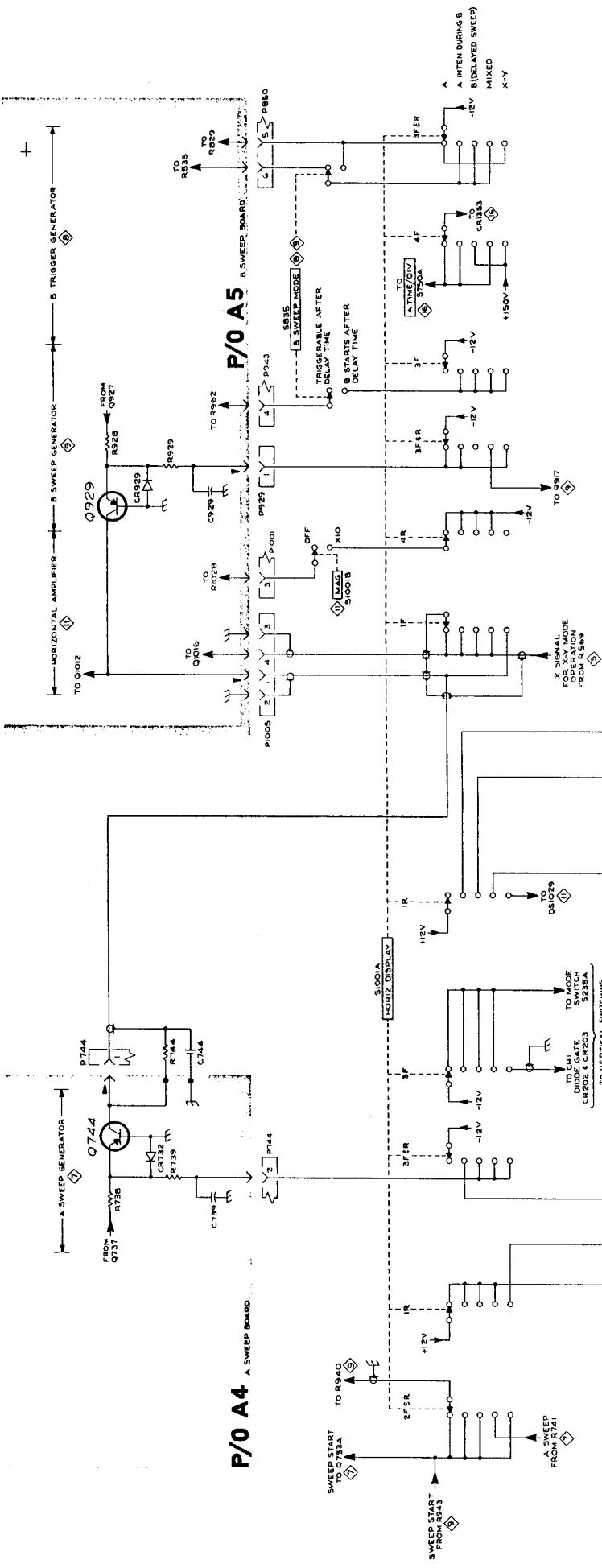

REFERENCE DIAGRAM A-5

- ① VERTICAL SWITCHING
- ② VERTICAL DREAMP
- ③ TRIGGER GENERATOR
- ④ A SWEEP GENERATOR
- ⑤ B TRIGGER GENERATOR
- ⑥ B SWEEP GENERATOR
- ⑦ HORIZONTAL AMPLIFIER
- ⑧ X AXIS AMPLIFIER

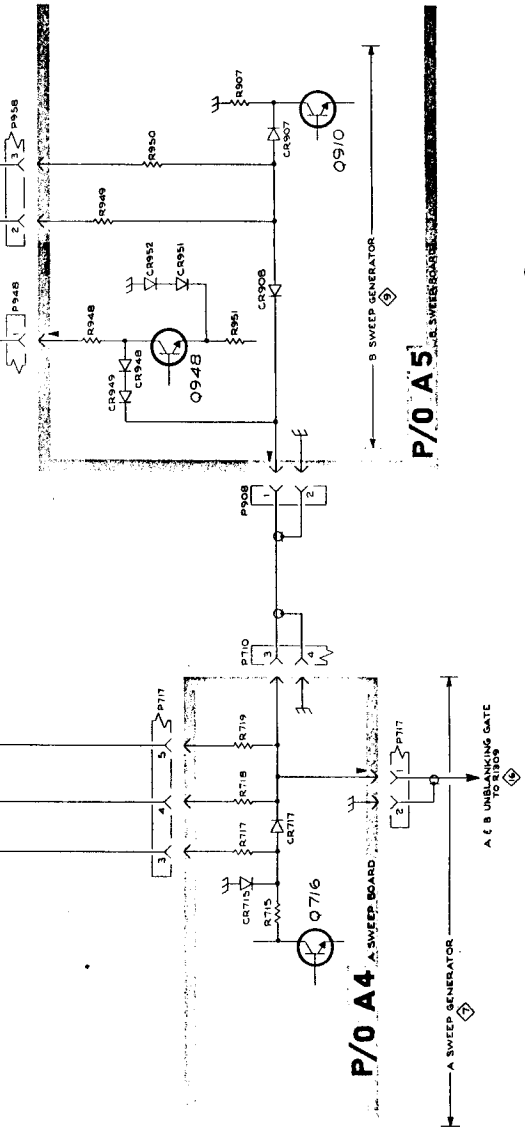

For Service Manuals Contact  
 MAURITRON TECHNOLOGICAL SERVICES  
 8 Cherry Tree Rd, Oxon  
 Oxon OX9 4CY  
 Tel: 01044-331004 Fax: 01044-355054  
 Email: enquiries@mauritron.co.uk

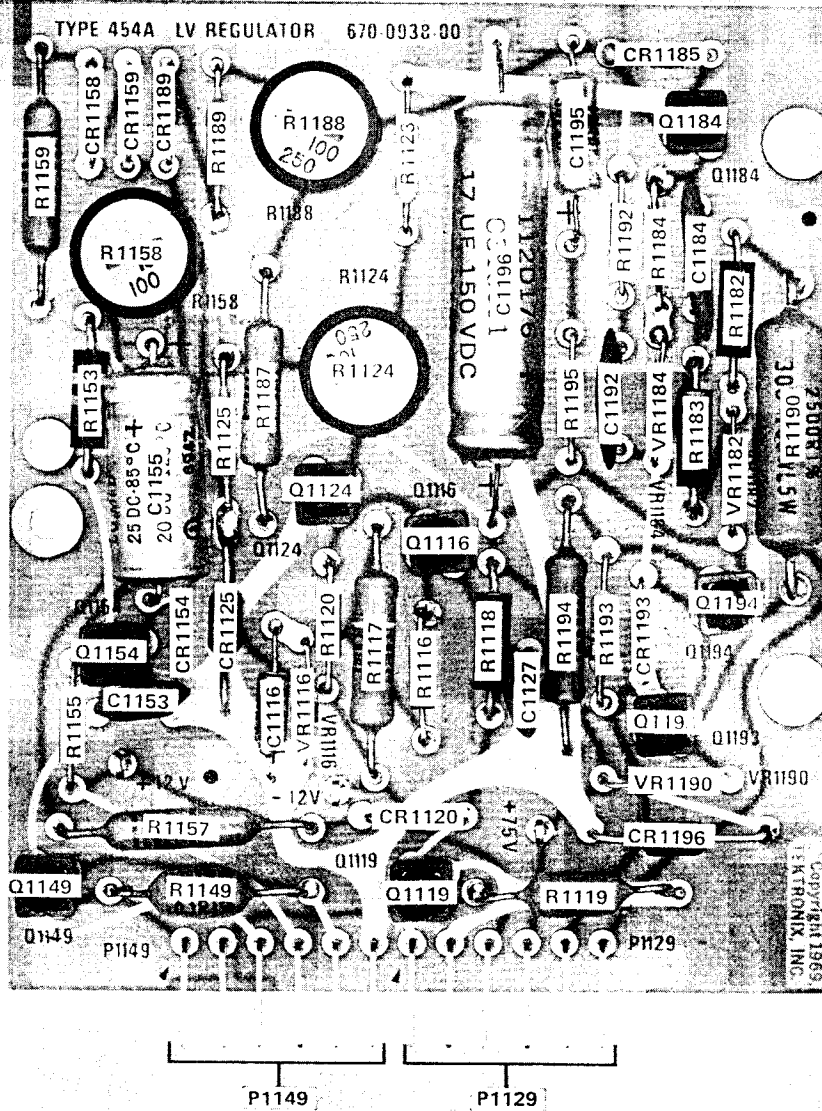
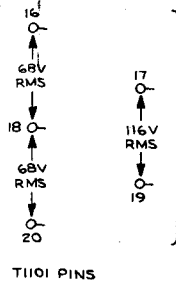
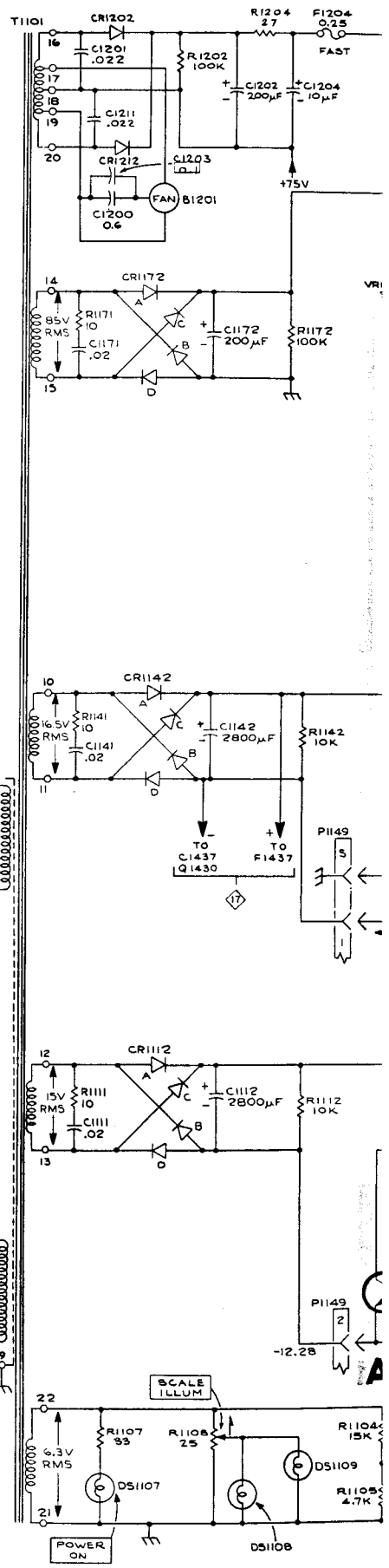
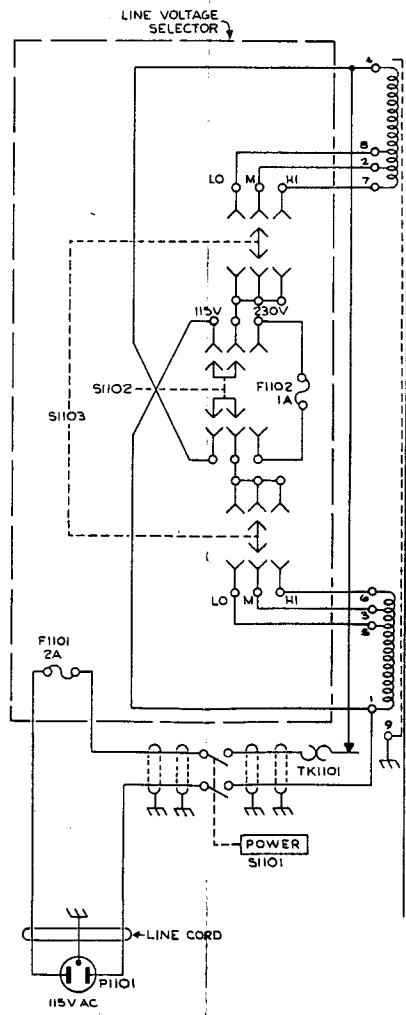

Fig. 8-13. Low Voltage Power Supply circuit board—A6.



VOLTAGES obtained under conditions given on page 82.



454A OSCILLOSCOPE

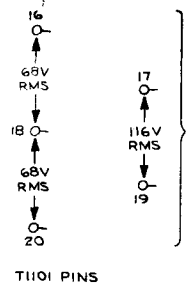

Under conditions given on page

VOLTAGE SELECTOR

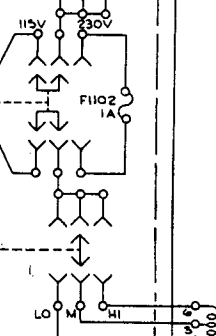

POWER SWITCH

454A OSCILLOSCOPE

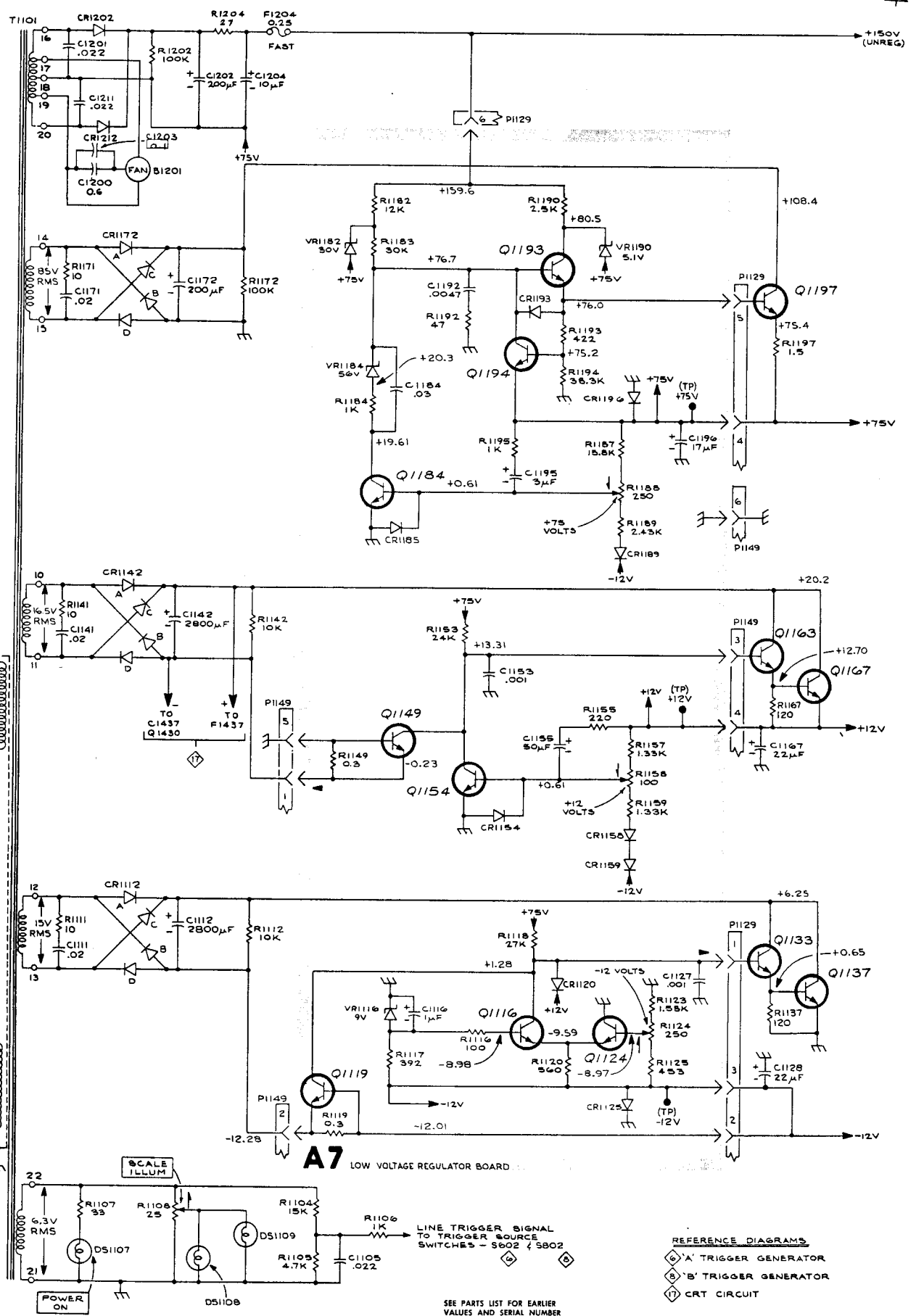

A7 LOW VOLTAGE REGULATOR BOARD

- REFERENCE DIAGRAMS
- (A) 'A' TRIGGER GENERATOR
  - (B) 'B' TRIGGER GENERATOR
  - (C) CRT CIRCUIT

SEE PARTS LIST FOR EARLIER VALUES AND SERIAL NUMBER RANGES OF PARTS MARKED WITH BLUE OUTLINE.

NOTE: SEE PARTS LIST FOR SEMICONDUCTOR TYPES

POWER SUPPLY

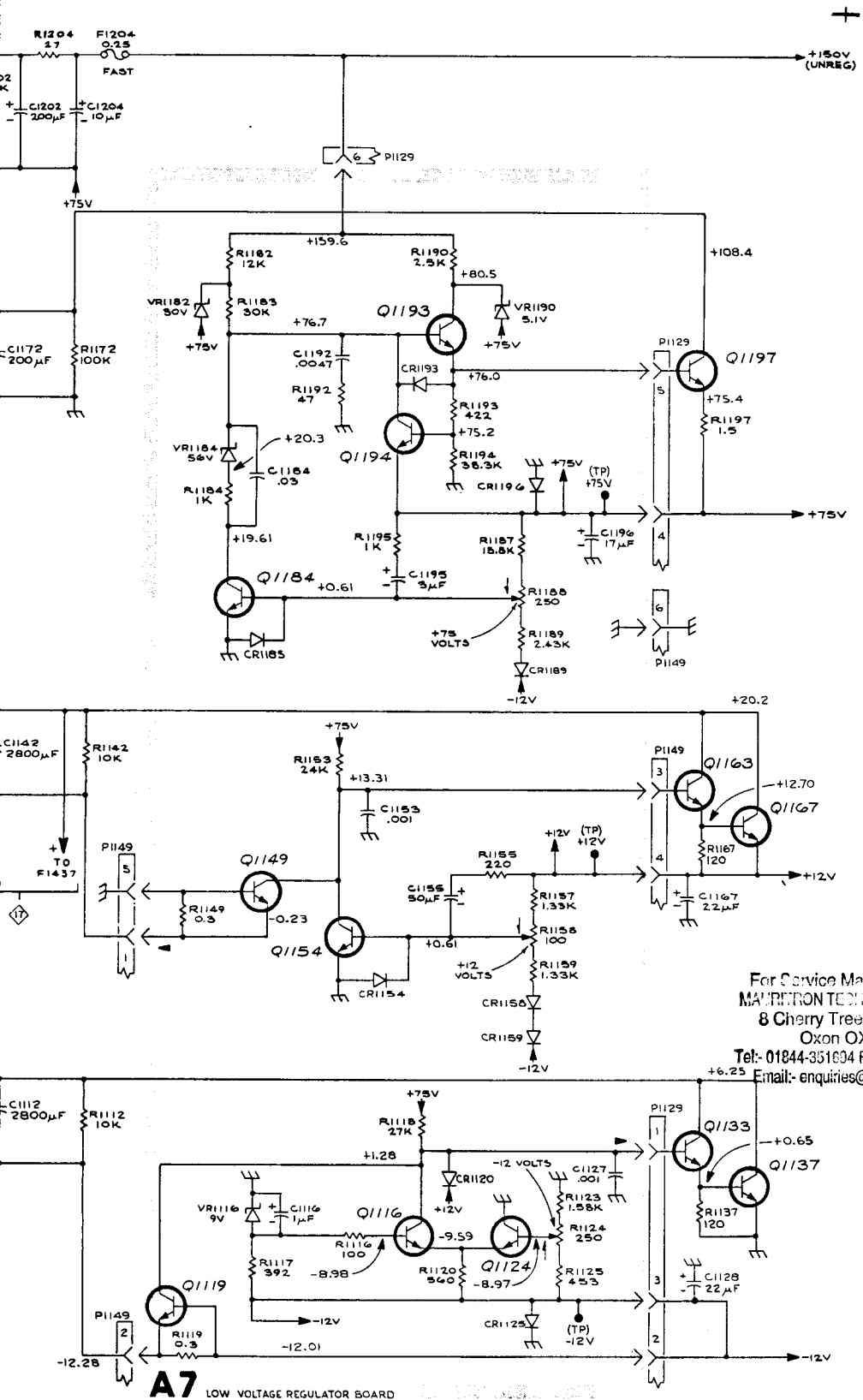

**A7** LOW VOLTAGE REGULATOR BOARD

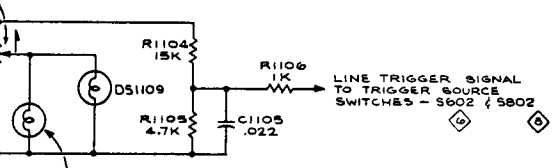

LINE TRIGGER SIGNAL TO TRIGGER SOURCE SWITCHES - S602 & S802

SEE PARTS LIST FOR EARLIER VALUES AND SERIAL NUMBER RANGES OF PARTS MARKED WITH BLUE OUTLINE.

**REFERENCE DIAGRAMS**

- ⊠ A' TRIGGER GENERATOR
- ⊡ B' TRIGGER GENERATOR
- ⊞ CRT CIRCUIT

NOTE: SEE PARTS LIST FOR SEMICONDUCTOR TYPES

**POWER SUPPLY**

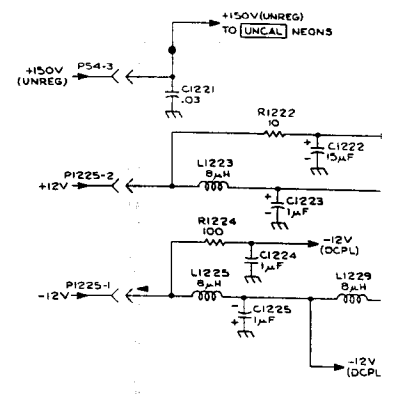

**A1** VERTICAL PREAMP BOARD

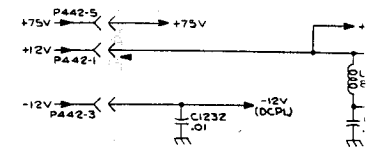

**A2** VERTICAL OUTPUT BOARD

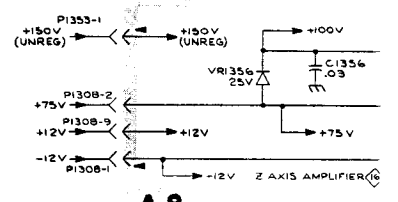

**A8** Z AXIS BOARD

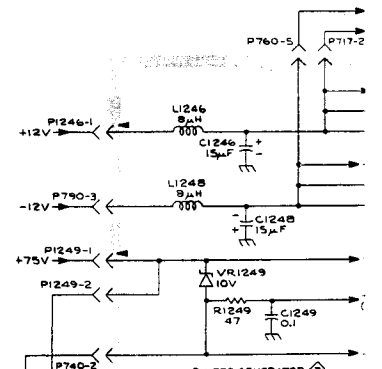

**A4** A SWEEP BOARD

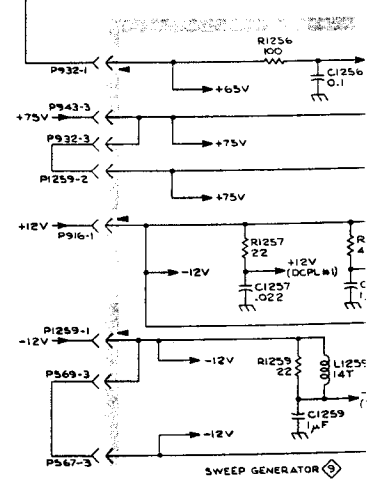

**A5** B SWEEP BOARD

For Service Manuals Contact  
**MAINTRON TECHNICAL SERVICES**  
 8 Cherry Tree Rd, Chalfont  
 Oxon OX9 4CY  
 Tel: 01844-351694 Fax: 01844-97554  
 Email: enquiries@maintron.co.uk



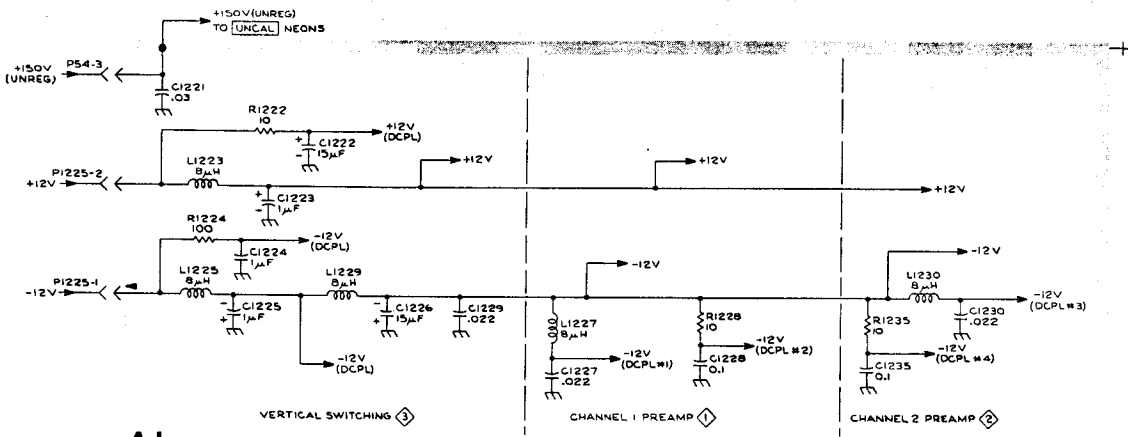

**A1** VERTICAL PREAMP BOARD

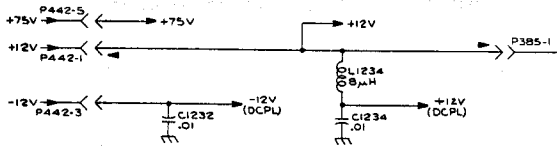

**A2** MAIN VERT AMP BOARD

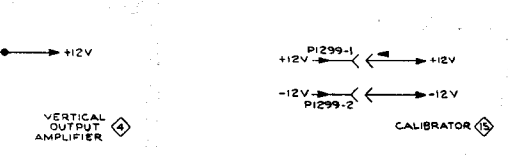

**A3** THICK FILM HYBRID CIRCUIT BOARD

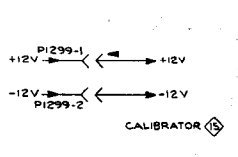

**A6** CALIBRATOR BOARD

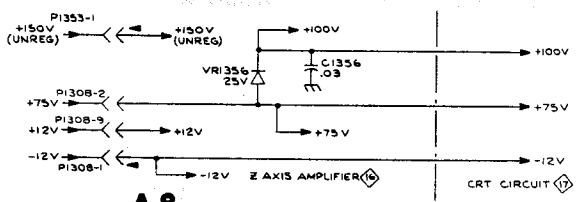

**A8** Z AXIS BOARD

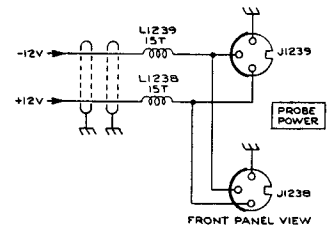

FRONT PANEL VIEW

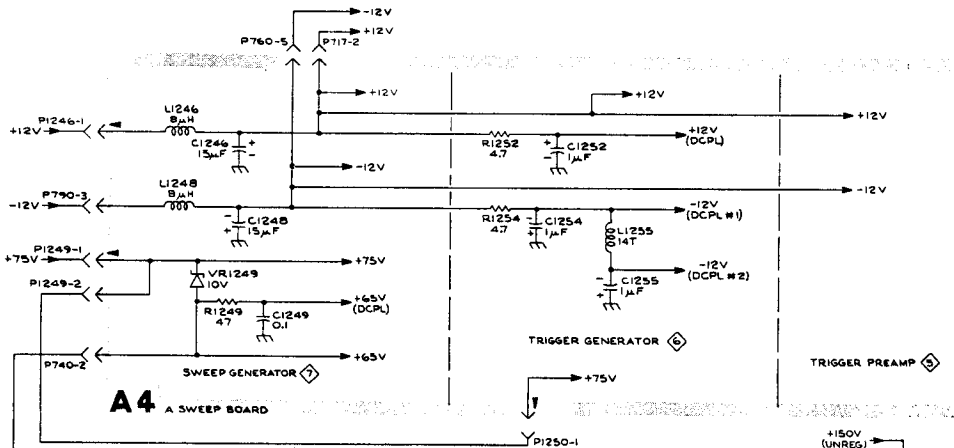

**A4** A SWEEP BOARD

**A5** B SWEEP BOARD

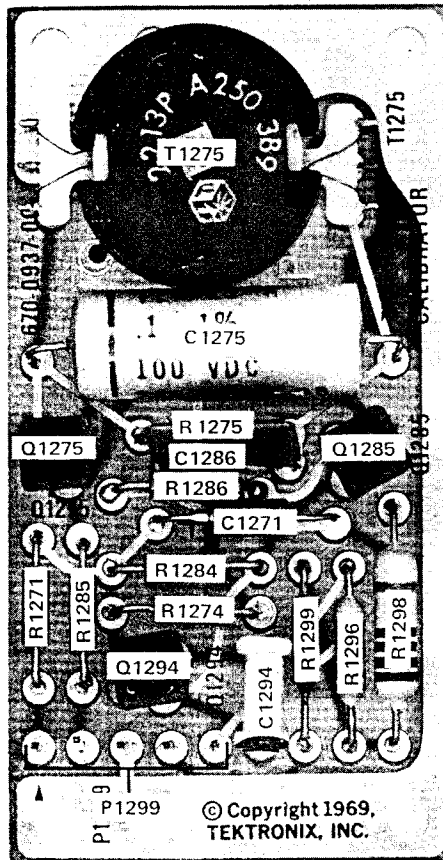
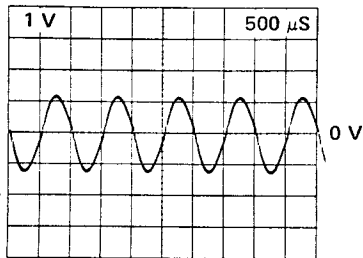

Fig. 8-14. Calibrator circuit board-A7.

For Components  
 MAINTENANCE  
 8 Cherry Hill  
 O...  
 Tel: 01044-3...  
 Email: eng...

1



2

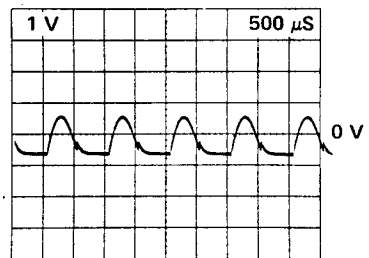

3

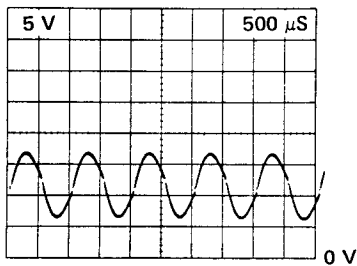

4

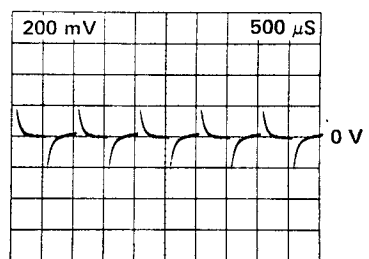

5

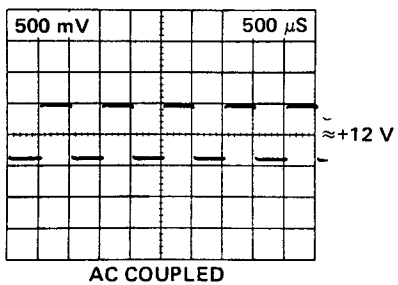

6

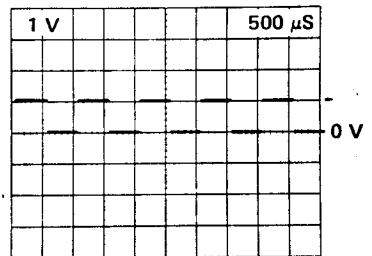

+

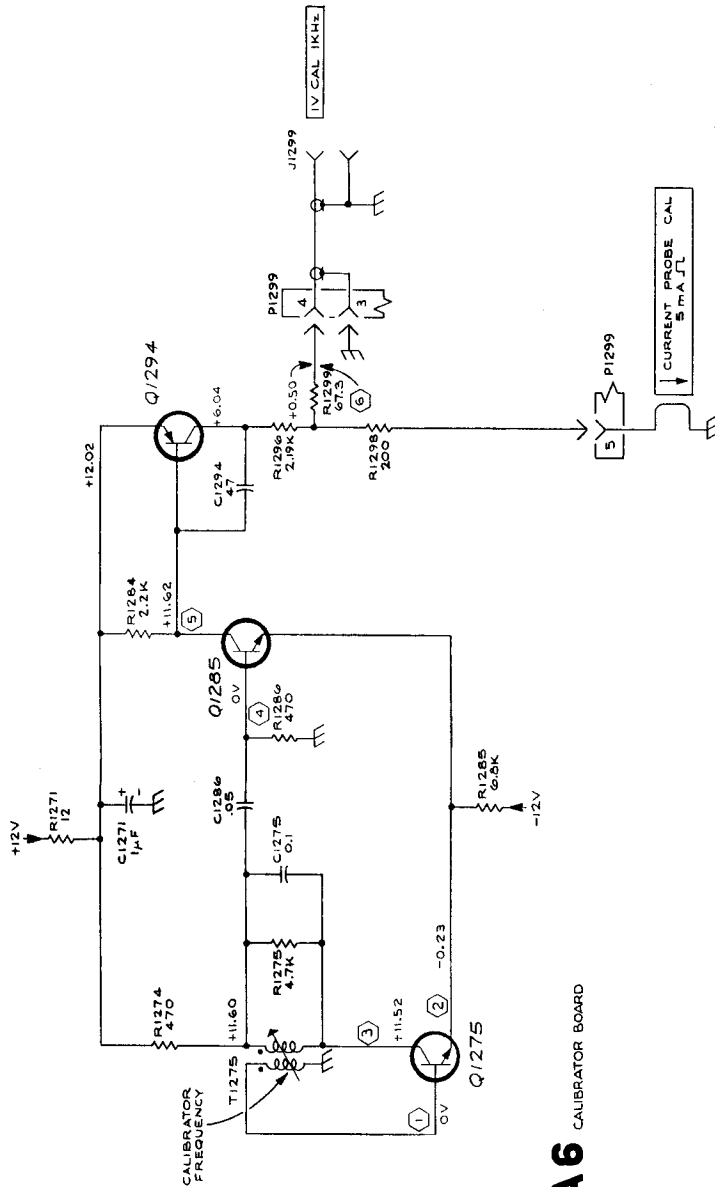

A6 CALIBRATOR BOARD

NOTES:  
 1. SEE PARTS LIST FOR SEMICONDUCTOR TYPES  
 2. SEE 4 FOR POWER DISTRIBUTION

4

For Service Manuals Contact  
**MAURITRON TECHNOLOGIES**  
 8 Cherry Tree Way, Chilton  
 Oxon OX9 4QY  
 Tel: 01244-831094 Fax: 01244-851504  
 Email: enquiries@mauritron.co.uk

WAVEFORMS

VOLTAGES and WAVEFORMS obtained under conditions given on page 8.2.

454A OSCILLOSCOPE

+

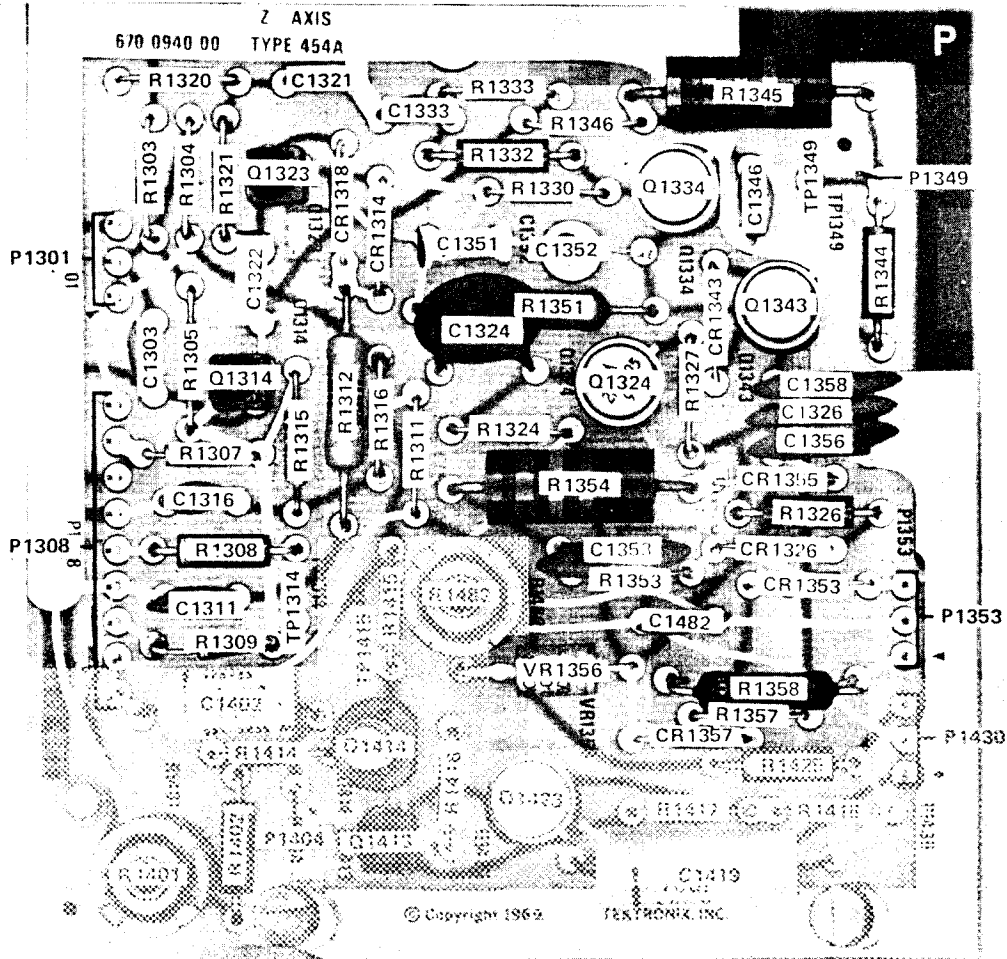
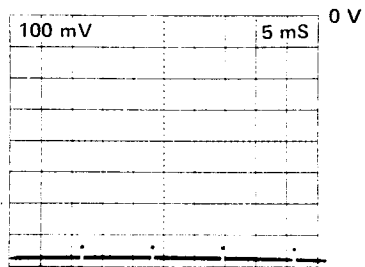
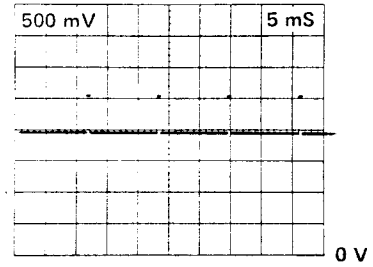

Fig. 8-15. Z-Axis circuit board—A8. Z-Axis Amplifier circuit shown.

1



2



3

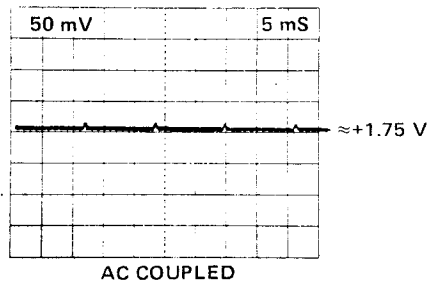

4

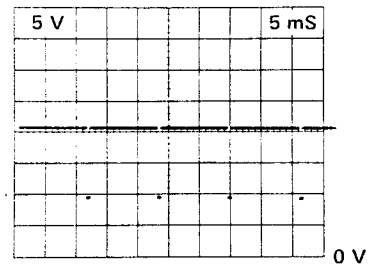

5

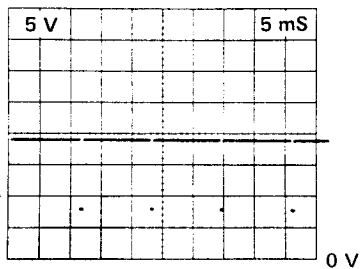

For Service Manuals Contact  
MAURITON TECHNICAL SERVICES  
8 Cherry Tree Rd, Chinnor  
Oxon OX9 4CY  
Tel: 01244-351034 Fax: 01244-350554  
Email: enquiries@mauriton.co.uk

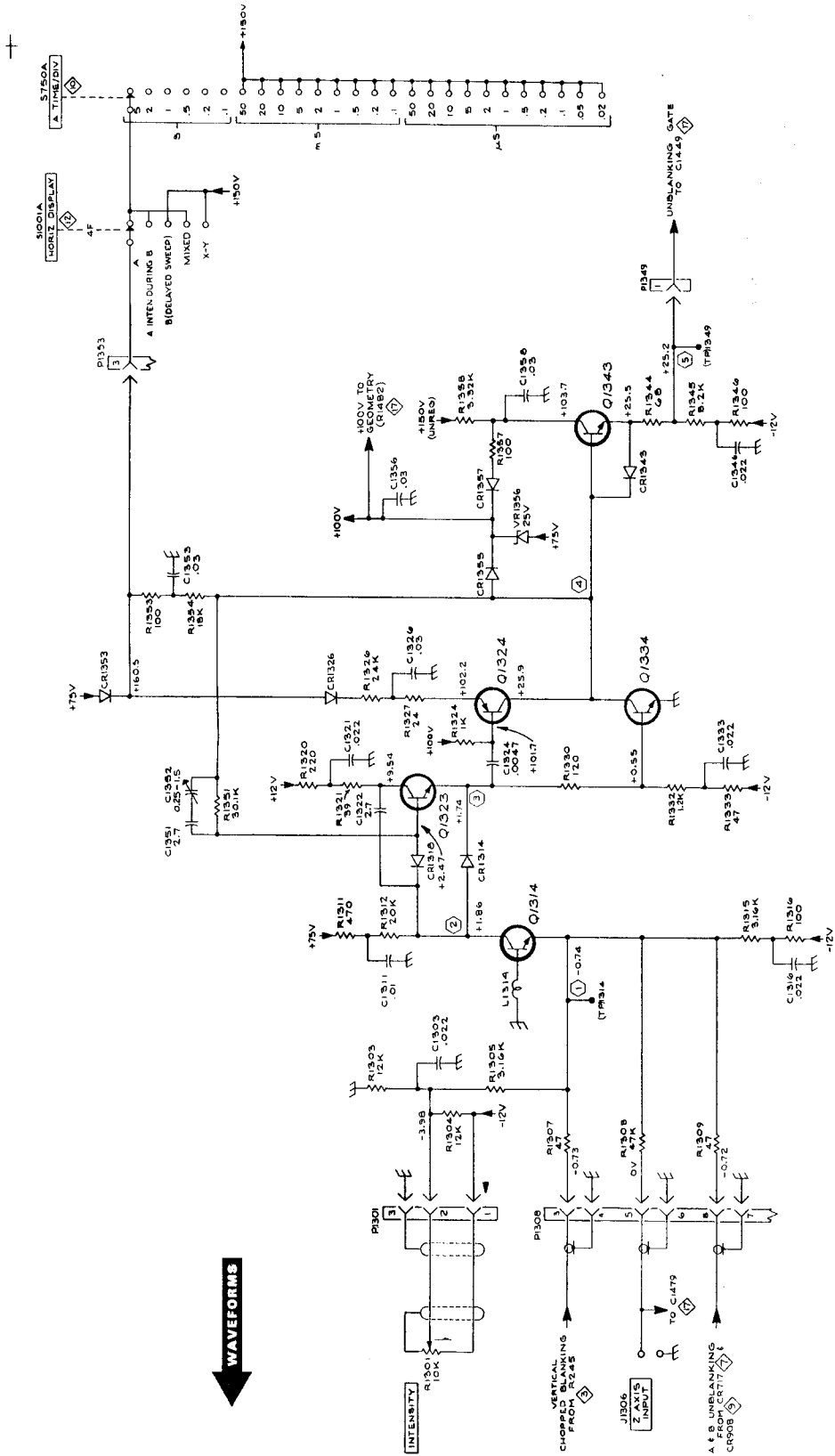

P/O A8 Z AXIS BOARD

VOLTAGES and WAVEFORMS obtained under conditions given on page 8-2.

- REFERENCE DIAGRAMS
- ① VERTICAL SWITCHING
  - ② A SWEEP GENERATOR
  - ③ B SWEEP GENERATOR
  - ④ A + B TIMING SWITCH
  - ⑤ HORIZONTAL DISPLAY SWITCH
  - ⑥ POWER DISTRIBUTION & DECOUPLING
  - ⑦ CRT CIRCUIT

NOTE: SEE PARTS LIST FOR SEMICONDUCTOR TYPES

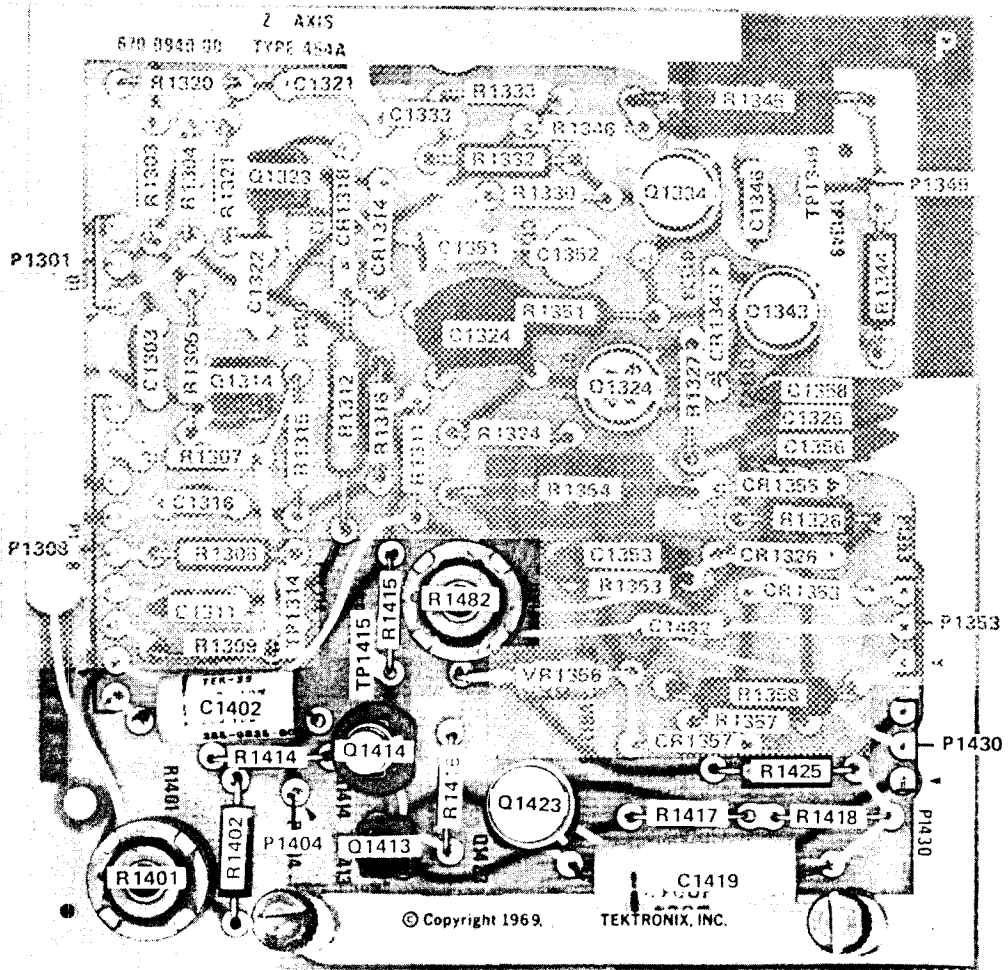
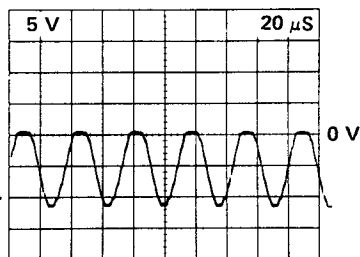

Fig. 8-16. Z-Axis circuit board—A8. CRT circuit shown.



1



2

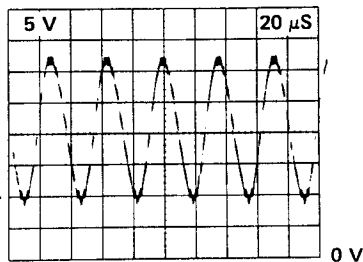

For Service Manuals Contact  
MAURITRON TECHNICAL SERVICES  
8 Cherry Tree Rd, Chinnor  
Oxon OX20 4QY  
Tel: 01844-351694 Fax: 01844-352554  
Email: enquiries@mauritron.co.uk

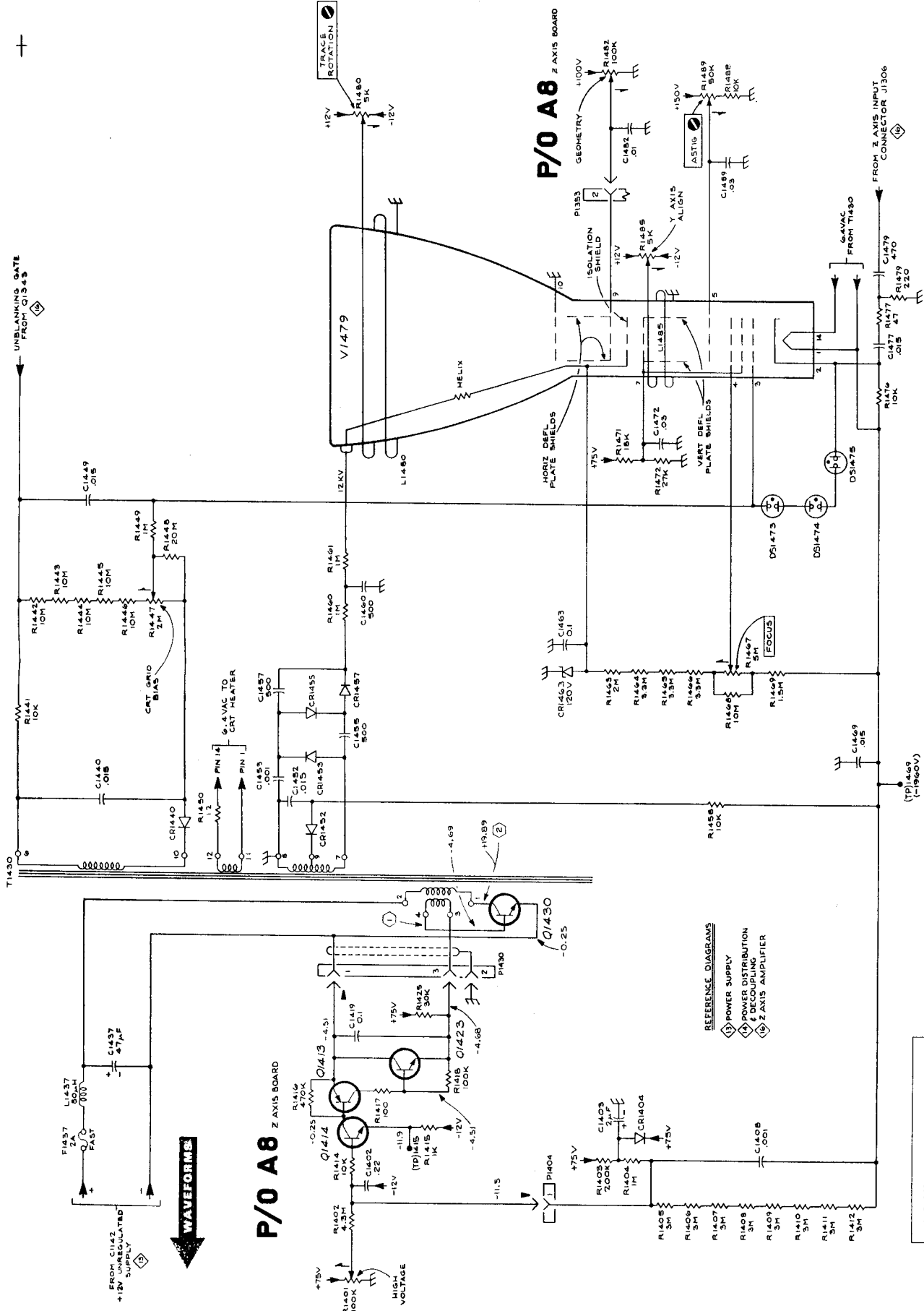

CRT CIRCUIT

(A)

NOTE: SEE PARTS LIST FOR SUBSTITUTION TYPES

454A OSCILLOSCOPE

VOLTAGES and WAVEFORMS obtained under conditions given on page 17.

REFERENCE DIAGRAMS  
 (1) POWER SUPPLY  
 (2) POWER DISTRIBUTION & REGULATING  
 (3) Z AXIS AMPLIFIER

For Service Manuals Contact  
MAURITRON TECHNICAL SERVICES  
8 Cherry Tree Rd, Chinnor  
Oxon OX9 4QY  
Tel: 01844-351694 Fax: 01844-352554  
Email: enquiries@mauritron.co.uk

## FIGURE AND INDEX NUMBERS

Items in this section are referenced by figure and index numbers to the illustrations which appear either on the back of the diagrams or on pullout pages immediately following the diagrams of the instruction manual.

## INDENTATION SYSTEM

This mechanical parts list is indented to indicated item relationships. Following is an example of the indentation system used in the Description column.

*Assembly and/or Component*  
*Detail Part of Assembly and/or Component*  
*mounting hardware for Detail Part*  
*Parts of Detail Part*  
*mounting hardware for Parts of Detail Part*  
*mounting hardware for Assembly and/or Component*

Mounting hardware always appears in the same indentation as the item it mounts, while the detail parts are indented to the right. Indented items are part of, and included with, the next higher indentation.

**Mounting hardware must be purchased separately, unless otherwise specified.**

## PARTS ORDERING INFORMATION

Replacement parts are available from or through your local Tektronix, Inc. Field Office or representative.

Changes to Tektronix instruments are sometimes made to accommodate improved components as they become available, and to give you the benefit of the latest circuit improvements developed in our engineering department. It is therefore important, when ordering parts, to include the following information in your order: Part number, instrument type or number, serial or model number, and modification number if applicable.

If a part you have ordered has been replaced with a new or improved part, your local Tektronix, Inc. Field Office or representative will contact you concerning any change in part number.

Change information, if any, is located at the rear of this manual.

## ABBREVIATIONS AND SYMBOLS

For an explanation of the abbreviations and symbols used in this section, please refer to the page immediately preceding the Electrical Parts List in this instruction manual.

## INDEX OF MECHANICAL PARTS LIST & ILLUSTRATIONS

Title	Page Nos. of Parts List
Figure 1 Front & CRT Shield .....	9-1 thru 9-9
Figure 2 Attenuator & High Voltage .....	9-10 thru 9-14
Figure 3 Chassis .....	9-15 thru 9-23
Figure 4 454A Frame & Cabinet .....	9-24 thru 9-26
Figure 5 R454A Cabinet .....	9-27 thru 9-28
Figure 6 Standard Accessories .....	<b>(parts list combined with illustration)</b>
Figure 7 454A Repackaging .....	<b>(parts list combined with illustration)</b>
Figure 8 R454A Repackaging .....	<b>(parts list combined with illustration)</b>

# SECTION 9

## MECHANICAL PARTS LIST

FIGURE 1 FRONT &amp; CRT SHIELD

Fig. & Index No.	Tektronix Part No.	Serial/Model Eff	No. Disc	Q						Description	
				y	1	2	3	4	5		
1-	378-0664-00			1						1	FILTER, light, CRT, 2.203 x 3.383 inches (not shown)
-1	354-0248-00			1						1	RING, ornamental
	214-0996-00			1						1	SPRING, filter
	331-0272-00	B010100	B089999	1						1	MASK-LIGHT REFLECTOR, CRT
	- - - - -			-						-	mask-light reflector includes:
-2	378-0782-00			1						1	REFLECTOR, light, plastic
-3	331-0270-00			1						1	MASK, graticule
	331-0270-01	B090000		1						1	MASK, CRT graticule
	378-0782-01	B090000		1						1	REFLECTOR, light
-4	386-1784-00			1						1	LIGHT CONDUCTOR, graticule
-5	344-0220-00			2						2	CLIP, spring fension
-6	348-0070-01			4						4	CUSHION, CRT
-7	337-1414-00			1						1	SHIELD, light
-8	136-0396-00			2						2	SOCKET, graticule lamp
	- - - - -			-						-	mounting hardware for each: (not included w/socket)
-9	210-0586-00			1						1	NUT, keps, 4-40 x 0.25 inch
-10	210-0202-00			2						2	LUG, solder, SE #6
	- - - - -			-						-	mounting hardware for each: (not included w/lug)
-11	210-0407-00			2						2	NUT, hex., 6-32 x 0.25 inch
-12	210-0006-00			1						1	WASHER, lock, internal, 0.146 ID x 0.283 inch OD
-13	211-0589-00			1						1	SCREW, 6-32 x 0.312 inch, PHB
-14	- - - - -			1						1	COIL
	- - - - -			-						-	mounting hardware: (not included w/coil)
-15	213-0149-00			3						3	SCREW, thread forming, 6-32 x 0.312 inch, PHB
-16	343-0123-01			2						2	CLAMP, CRT retainer
	- - - - -			-						-	mounting hardware: (not included w/clamp)
-17	211-0600-00			1						1	SCREW, 6-32 x 2 inches, Fil HS
-18	220-0444-00			1						1	NUT, square, 6-32 x 0.25 inch
-19	343-0124-00			1						1	CLAMP, retainer, plastic
	- - - - -			-						-	mounting hardware: (not included w/clamp)
-20	211-0599-00			2						2	SCREW, 6-32 x 0.75 inch, Fil HS
-21	220-0444-00			2						2	NUT, square, 6-32 x 0.25 inch
-22	352-0091-01			2						2	HOLDER, CRT retainer
	- - - - -			-						-	mounting hardware for each: (not included w/holder)
-23	211-0590-00			2						2	SCREW, 6-32 x 0.25 inch, PHB

For Service Manuals Contact  
 MAUNTON LTD, 211-0599-00  
 8 Cherry Tree Way, Dunbar  
 Oxon OX9 4CY  
 Tel: 01044-631004 Fax: 01044-631054  
 Email: enquiries@maunton.co.uk

FIGURE 1 FRONT & CRT SHIELD (cont)

Fig. & Index No.	Tektronix Part No.	Serial/Model No. Eff	No. Disc	Q					Description	
				y	1	2	3	4		5
1-24	343-0131-00			1						CLAMP, coil form
	- - - - -			-						mounting hardware: <i>(not included w/clamp)</i>
-25	211-0590-00			2						SCREW, 6-32 x 0.25 inch, PHB
-26	210-0006-00			2						WASHER, lock, internal, 0.146 ID x 0.283 inch OD
-27	210-0407-00			2						NUT, hex., 6-32 x 0.25 inch
-28	337-1010-01			1						SHIELD, CRT
	- - - - -			-						mounting hardware: <i>(not included w/shield)</i>
-29	211-0510-00			2						SCREW, 6-32 x 0.375 inch, PHS
-30	210-0949-00			4						WASHER, flat, 0.141 ID x 0.50 inch OD
-31	343-0122-01			2						CLAMP, CRT shield
-32	213-0049-00			2						SCREW, 6-32 x 0.312 inch, HHB
-33	358-0281-00			1						BUSHING, CRT cable
-34	366-0494-00			1						KNOB, charcoal—INTENSITY
	- - - - -			-						knob includes:
	213-0153-00			1						SETSCREW, 5-40 x 0.125 inch, HSS
-35	366-0494-00			1						KNOB, charcoal—FOCUS
	- - - - -			-						knob includes:
	213-0153-00			1						SETSCREW, 5-40 x 0.125 inch, HSS
-36	366-0494-00			1						KNOB, charcoal—SCALE ILLUM
	- - - - -			-						knob includes:
	213-0153-00			1						SETSCREW, 5-40 x 0.125 inch, HSS
-37	366-1265-00			2						KNOB, red—VARIABLE (CH 1 & 2)
	- - - - -			-						each knob includes:
	213-0153-00			1						SETSCREW, 5-40 x 0.125 inch, HSS
-38	366-1001-00			2						KNOB, charcoal—VOLTS/DIV (CH 1 & 2)
	- - - - -			-						each knob includes:
	213-0153-00			2						SETSCREW, 5-40 x 0.125 inch, HSS
-39	366-0494-00			2						KNOB, charcoal—CHANNEL 1 & 2 POSITION
	- - - - -			-						each knob includes:
	213-0153-00			1						SETSCREW, 5-40 x 0.125 inch, HSS
-40	366-1247-00			1						KNOB, red—A & B VARIABLE
	- - - - -			-						knob includes:
	213-0153-00			1						SETSCREW, 5-40 x 0.125 inch, HSS
-41	366-1248-00			1						KNOB, charcoal—A & B TIME/DIV & DELAY TIME
	- - - - -			-						knob includes:
	213-0022-00			2						SETSCREW, 4-40 x 0.188 inch, HSS
-42	334-1598-00			1						PLATE, information
-43	354-0385-00			1						RING, knob skirt
	- - - - -			-						ring includes:
	213-0022-00			2						SETSCREW, 4-40 x 0.188 inch, HSS
-44	366-1163-00			1						KNOB, gray—INT TRIG
	- - - - -			-						knob includes:
	213-0153-00			1						SETSCREW, 5-40 x 0.125 inch, HSS
-45	366-1057-00			1						KNOB, charcoal—MODE
	- - - - -			-						knob includes:
	213-0153-00			2						SETSCREW, 5-40 x 0.125 inch, HSS

FIGURE 1 FRONT &amp; CRT SHIELD (cont)

Fig. & Index No.	Tektronix Part No.	Serial/Model No.		Q t y	Description
		Eff	Disc		
1-46	366-1163-00			1	KNOB, gray—MAG
	213-0153-00			-	knob includes:
				1	SETSCREW, 5-40 x 0.125 inch, HSS
-47	366-1057-00			1	KNOB, charcoal—HORIZ DISPLAY
	213-0153-00			-	knob includes:
				2	SETSCREW, 5-40 x 0.125 inch, HSS
-48	366-1039-00			1	KNOB, charcoal—A SWEEP LENGTH
	213-0153-00			-	knob includes:
				1	SETSCREW, 5-40 x 0.125 inch, HSS
-49	366-1039-00			1	KNOB, charcoal—LEVEL (B TRIGGERING)
	213-0153-00			-	knob includes:
				1	SETSCREW, 5-40 x 0.125 inch, HSS
-50	366-1246-00			1	KNOB, gray—HF STAB
	213-0153-00			-	knob includes:
				2	SETSCREW, 5-40 x 0.125 inch, HSS
-51	366-1244-00			1	KNOB, charcoal—LEVEL (A TRIGGERING)
	213-0153-00			-	knob includes:
				2	SETSCREW, 5-40 x 0.125 inch, HSS
-52	366-1246-00			1	KNOB, gray—FINE
	213-0153-00			-	knob includes:
				2	SETSCREW, 5-40 x 0.125 inch, HSS
-53	366-1244-00			1	KNOB, charcoal—POSITION
	213-0153-00			-	knob includes:
				2	SETSCREW, 5-40 x 0.125 inch, HSS
-54	366-0215-02			10	KNOB, lever switch
-55	366-1024-01			1	KNOB, charcoal—B TIME/DIV
	213-0153-00			-	knob includes:
				2	SETSCREW, 5-40 x 0.125 inch, HSS
	129-0103-00			1	BINDING POST ASSEMBLY
				-	binding post assembly includes:
-56	200-0103-00			1	CAP, binding post
-57	129-0077-00			1	POST, binding
				-	mounting hardware: (not included w/binding post assembly)
-58	210-0583-00			1	NUT, hex., 0.25-32 x 0.312 inch
-59	210-0046-00			1	WASHER, lock, internal, 0.261 ID x 0.40 inch OD
-60	358-0378-00			2	BUSHING, sleeve, front panel trim, 0.188 inch OD
-61	358-0301-02			2	BUSHING, sleeve, 0.185 inch diameter
-62	131-0438-01			1	CONNECTOR, 3 contact, female
				-	mounting hardware: (not included w/connector)
-63	220-0598-00			1	NUT, sleeve, hex., 9 mm x 0.437 x 0.36 inch long
	210-0012-00			1	WASHER, lock, internal, 0.375 ID x 0.50 inch OD
-64	131-0438-01			1	CONNECTOR, 3 contact, female
				-	mounting hardware: (not included w/connector)
-65	210-0590-00			1	NUT, hex., 0.375-32 x 0.438 inch
-66	210-0012-00			1	WASHER, lock, internal, 0.375 ID x 0.50 inch OD

For Service Manuals Contact  
 MAGEC INTERNATIONAL LTD  
 8 Cherry Lane, Borehamwood  
 Oxon OX9 3EJ  
 Tel: 01844-351034 Fax: 01844-351054  
 Email: enquiries@magec.co.uk

FIGURE 1 FRONT & CRT SHIELD (cont)

Fig. & Index No.	Tektronix Part No.	Serial/Model No. Eff	No. Disc	Q					Description	
				y	1	2	3	4		5
1-67	407-0789-00			1						BRACKET, grounding, subpanel to support
	- - - - -			-						mounting hardware: <i>(not included w/bracket)</i>
	210-0586-00			2						NUT, keps, 4-40 x 0.25 inch <i>(not shown)</i>
	210-0201-00			1						LUG, solder, SE #4 <i>(not shown)</i>
-68	333-1322-00			1						PANEL, front
-69	- - - - -			3						RESISTOR, variable
	- - - - -			-						mounting hardware for each: <i>(not included w/resistor)</i>
-70	210-0583-00			2						NUT, hex., 0.25-32 x 0.312 inch
-71	210-0940-00			1						WASHER, flat, 0.25 ID x 0.375 inch OD
-72	210-0046-00			1						WASHER, lock, internal, 0.25 ID x 0.40 inch OD
-73	200-0608-00			1						COVER, plastic, variable resistor
-74	260-1143-00			1						SWITCH, lever—BEAM FINDER
	- - - - -			-						mounting hardware: <i>(not included w/switch)</i>
-75	210-0580-00			1						NUT, hex., 0.312-24 x 0.375 inch
-76	210-1025-00			1						WASHER, flat, 0.312 ID x 0.474 inch, OD
-77	- - - - -			1						RESISTOR, variable, w/hardware
	- - - - -			-						mounting hardware: <i>(not included w/resistor)</i>
-78	331-0139-00			1						DIAL—DELAY TIME MULTIPLIER
	- - - - -			-						dial includes:
	213-0048-00			1						SETSCREW, 4-40 x 0.125 inch, HSS
-79	- - - - -			2						RESISTOR, variable
	- - - - -			-						mounting hardware: <i>(not included w/resistor)</i>
-80	210-0590-00			1						NUT, hex., 0.375-32 x 0.438 inch
	210-0978-00			1						WASHER, flat, 0.375 ID x 0.50 inch OD
-81	210-0012-00			1						WASHER, lock, internal, 0.375 ID x 0.50 inch OD
-82	- - - - -			1						RESISTOR, variable
	- - - - -			-						mounting hardware: <i>(not included w/resistor)</i>
-83	358-0029-05			1						BUSHING, hex., 0.50 inch long
-84	210-0840-00			1						WASHER, flat, 0.39 ID x 0.562 inch OD
-85	210-0012-00			1						WASHER, lock, internal, 0.375 ID x 0.50 inch OD
-86	129-0167-00			1						POST, hex., 0.375-32 x 0.50 x 0.688 inch long
-87	210-0255-00			1						LUG, solder, 0.375 inch
-88	260-0834-00			1						SWITCH, toggle—POWER ON
	- - - - -			-						mounting hardware: <i>(not included w/switch)</i>
-89	210-0562-00			1						NUT, hex., 0.25-40 x 0.312 inch
-90	210-0940-00			1						WASHER, flat, 0.25 ID x 0.375 inch OD
-91	210-0046-00			1						WASHER, lock, internal, 0.25 ID x 0.40 inch OD



FIGURE 1 FRONT &amp; CRT SHIELD (cont)

Fig. & Index No.	Tektronix Part No.	Serial/Model No.		Q † Y	Description
		Eff	Disc		
1-92	136-0223-00			1	SOCKET, light
-93	210-0562-00			-	mounting hardware: (not included w/socket)
-94	210-0223-00			1	NUT, hex., 0.25-40 x 0.312 inch
				1	LUG, solder, 0.25 ID x 0.438 inch OD
-95	131-0955-00			3	CONNECTOR, BNC, female, w/hardware
				-	mounting hardware for each: (not included w/connector)
-96	210-0590-00			1	NUT, hex., 0.375-32 x 0.438 inch
-97	352-0084-00			2	HOLDER, neon, black
-98	352-0084-01			3	HOLDER, neon, white
-99	378-0541-00			1	FILTER, lens, green
-100	378-0541-01			4	FILTER, lens, white
-101	200-0609-00			5	COVER, neon holder
-102	260-1153-00			1	SWITCH, rotary—HORIZ DISPLAY, unwired
				-	mounting hardware: (not included w/switch)
-103	210-0590-00			1	NUT, hex., 0.375-32 x 0.438 inch OD
-104	210-0012-00			1	WASHER, lock, internal, 0.375 ID x 0.50 inch OD
-105	262-0910-00			1	SWITCH, rotary—A SWEEP LENGTH, wired
				-	switch includes:
	260-0825-00			1	SWITCH, rotary, unwired
-106				1	RESISTOR, variable
				-	mounting hardware: (not included w/resistor)
-107	210-0590-00			2	NUT, hex., 0.375-32 x 0.438 inch
-108	210-0012-00			1	WASHER, lock, internal, 0.375 ID x 0.50 inch OD
-109	361-0234-00			1	RESTRAINT, shaft coupling, 0.32 inch OD
-110	361-0233-00			1	RESTRAINT, shaft coupling, 0.188 inch OD
-111	376-0014-00			1	COUPLING, variable resistor
				-	mounting hardware: (not included w/switch)
-112	210-0590-00			1	NUT, hex., 0.375-32 x 0.438 inch
-113	210-0978-00			1	WASHER, flat, 0.375 ID x 0.50 inch OD
-114	210-0012-00			1	WASHER, lock, internal, 0.375 ID x 0.50 inch OD
-115	260-0472-00			1	SWITCH, lever—SLOPE (A TRIGGERING)
				-	mounting hardware: (not included w/switch)
-116	220-0413-00			1	NUT, switch, 4-40 x 0.188 x 0.562 inch long
-117	260-1150-00			1	SWITCH, lever—COUPLING (A TRIGGERING)
				-	mounting hardware: (not included w/switch)
	220-0413-00			2	NUT, switch, 4-40 x 0.188 x 0.562 inch long

For Service Manuals Contact  
**MAURITRON TECHNICAL SERVICES**  
 8 Cherry Tree Rd, Chinnor  
 Oxon OX9 4DY  
 Tel: 01844-351034 Fax: 01844-351054  
 Email: enquiries@mauratron.co.uk

FIGURE 1 FRONT & CRT SHIELD (cont)

Fig. & Index No.	Tektronix Part No.	Serial/Model No. Eff	No. Disc	Q					Description	
				t	y	1	2	3		4
1-118	260-1148-00			1						SWITCH, lever—SOURCE (A TRIGGERING)
	- - - - -			-						mounting hardware: (not included w/switch)
	220-0413-00			1						NUT, switch, 4-40 x 0.188 x 0.562 inch long
-119	260-1149-00			1						SWITCH, lever—A SWEEP MODE
	- - - - -			-						mounting hardware: (not included w/switch)
	220-0413-00			2						NUT, switch, 4-40 x 0.188 x 0.562 inch long
-120	260-0587-00			1						SWITCH, lever—B SWEEP MODE
	- - - - -			-						mounting hardware: (not included w/switch)
	220-0413-00			2						NUT, switch, 4-40 x 0.188 x 0.562 inch long
-121	260-0472-00			1						SWITCH, lever—SLOPE (B TRIGGERING)
	- - - - -			-						mounting hardware: (not included w/switch)
	220-0413-00			2						NUT, switch, 4-40 x 0.188 x 0.562 inch
-122	260-1150-00			1						SWITCH, lever—COUPLING (B TRIGGERING)
	- - - - -			-						mounting hardware: (not included w/switch)
	220-0413-00			2						NUT, switch, 4-40 x 0.188 x 0.562 inch
-123	260-1148-00			1						SWITCH, lever—SOURCE (B TRIGGERING)
	- - - - -			-						mounting hardware: (not included w/switch)
	220-0413-00			2						NUT, switch, 4-40 x 0.188 x 0.562 inch
-124	388-0839-00			2						CIRCUIT BOARD—T COIL
-125	337-1318-00			1						SHIELD, A triggering
	- - - - -			-						mounting hardware: (not included w/shield)
-126	211-0007-00			3						SCREW, 4-40 x 0.188 inch, PHS
	211-0116-00			1						SCREW, sems, 4-40 x 0.312 inch, PHB
-127	129-0270-00			2						POST, hex., 4-40 x 0.188 x 1.52 inches long
-128	260-0717-00			1						SWITCH, pushbutton—RESET
	- - - - -			-						mounting hardware: (not included w/switch)
-129	210-0590-00			1						NUT, hex., 0.375 32 x 0.438 inch
	210-0978-00			1						WASHER, flat, 0.375 ID x 0.50 inch OD
	210-0012-00			1						WASHER, lock, internal, 0.375 ID x 0.50 inch OD
-130	386-1779-02			1						SUBPANEL, front

FIGURE 1 FRONT &amp; CRT SHIELD (cont)

Fig. & Index No.	Tektronix Part No.	Serial/Model No. Eff	No. Disc	Q					Description	
				y	1	2	3	4		5
1-131	262-0909-00	B010100	B099999	1						SWITCH, rotary—A & B TIME/DIV & DELAY TIME, wired
	262-0909-02	B100000		1						SWITCH, rotary—A & B TIME/DIV & DELAY TIME, wired
	- - - - -			-						switch includes:
	260-1152-00			1						SWITCH, rotary, unwired
-132	179-1577-00			1						WIRING HARNESS, switch
-133	131-0622-00			5						CONNECTOR, terminal
	131-0792-00			2						CONNECTOR, terminal
-134	352-0198-00			5						HOLDER, terminal connector, 2 wire (black)
-135	- - - - -			1						CAPACITOR
	- - - - -			-						mounting hardware: (not included w/capacitor)
-136	210-0457-00			2						NUT, keps, 6-32 x 0.312 inch
-137	131-0181-00			2						CONNECTOR, terminal, standoff
	- - - - -			-						mounting hardware for each: (not included w/connector)
	358-0136-00			1						BUSHING, plastic
-138	348-0055-00			1						GROMMET, plastic, 0.25 inch diameter
-139	- - - - -			2						CAPACITOR
	- - - - -			-						mounting hardware for each: (not included w/capacitor)
-140	210-0524-00			1						NUT, hex., 0.312-24 x 0.50 inch
-141	210-0018-00			1						WASHER, lock internal, 0.312 ID x 0.594 inch OD
-142	- - - - -			1						RESISTOR, variable
	- - - - -			-						mounting hardware: (not included w/resistor)
-143	210-0413-00			2						NUT, hex., 0.375-32 x 0.50 inch
-144	210-0012-00			1						WASHER, lock, internal, 0.375 ID x 0.50 inch OD
-145	361-0234-00			1						RESTRAINT, shaft coupling, 0.32 inch OD
-146	361-0233-00			1						RESTRAINT, shaft coupling, 0.188 inch OD
-147	376-0014-00			1						COUPLING, variable resistor
-148	210-0802-00			1						WASHER, flat, 0.15 ID x 0.312 inch OD
-149	384-0262-00			1						ROD, shaft extension, 7.563 inches long
-150	407-0290-03			1						BRACKET, component mounting
	- - - - -			-						mounting hardware: (not included w/bracket)
-151	210-0449-00			2						NUT, hex., 5-40 x 0.25 inch
-152	210-0006-00			1						WASHER, lock, internal, 0.146 ID x 283 inch OD
-153	210-0202-00			1						LUG, solder, SE #6
	- - - - -			-						mounting hardware: (not included w/switch)
-154	210-0579-00			1						NUT, hex., 0.625-24 x 0.75 inch
-155	210-0049-00			1						WASHER, lock, internal, 0.625 inch ID
-156	211-0504-00			2						SCREW, 6-32 x 0.25 inch, PHS
	210-0457-00			1						NUT, keps, 6-32 x 0.312 inch (not shown)
-157	214-0335-00			1						BOLT, current loop
	- - - - -			-						mounting hardware: (not included w/bolt)
-158	210-0593-00			2						NUT, hex., current loop, 3-48 x 0.25 inch
-159	361-0059-00			1						SPACER, current loop
-160	210-0351-00			1						WASHER, 0.119 ID x 0.375 inch OD
-161	210-0801-00			1						WASHER, flat, 0.14 ID x 0.281 inch OD
	210 0004-00			1						WASHER, lock, internal, 0.12 ID x 0.26 inch OD
-162	210-0849-00			1						WASHER, fiber, shouldered, #4
-163	210-0201-00			1						LUG, solder, SE #4
-164	210-0442-00			1						NUT, hex., 3-48 x 0.188 inch

For Service Manuals Contact  
**MAURITRON TECHNICAL SERVICES**  
 8 Cherry Tree Road, Oxon  
 Oxon OX9 4TJ  
 Tel: 01844-851694 Fax: 01844-851694  
 Email: enquiries@mauritron.co.uk

FIGURE 1 FRONT & CRT SHIELD (cont)

Fig. & Index No.	Tektronix Part No.	Serial/Model Eff	No. Disc	Q					Description		
				Y	1	2	3	4		5	
1-165	200-0103-00			1						1	CAP, binding post
-166	129-0076-03			1						1	POST, binding
-	-			-						-	mounting hardware: (not included w/post)
-167	210-0410-00			1						1	NUT, hex., 10-32 x 0.312 inch
-168	210-0009-00			1						1	WASHER, lock, external, 0.193 ID x 0.40 inch OD
-169	333-1336-00			1						1	PANEL, front (calibrator chassis)
-170	-			1						1	RESISTOR, variable
-	-			-						-	mounting hardware: (not included w/resistor)
-171	210-0590-00			1						1	NUT, hex., 0.375-32 x 0.438 inch
-172	210-0012-00			1						1	WASHER, lock, internal, 0.375 ID x 0.50 inch OD
-173	-			1						1	RESISTOR, variable
-	-			-						-	mounting hardware: (not included w/resistor)
-174	358-0075-00			1						1	BUSHING, 0.25-32 x 0.375 inch
-175	131-0955-00			4						4	CONNECTOR, BNC, female, w/hardware
-	-			-						-	mounting hardware for each: (not included w/connector)
-176	210-0590-00			1						1	NUT, hex., 0.375-32 x 0.438 inch
-177	210-0255-00			1						1	LUG, solder, 0.375 inch, SE
-178	-			2						2	RESISTOR, variable
-	-			-						-	mounting hardware for each: (not included w/resistor)
-179	358-0075-00			1						1	BUSHING, banana jack
-180	210-0046-00			1						1	WASHER, lock, internal, 0.25 ID x 0.40 inch OD
-181	220-0510-00			1						1	NUT, hex., 0.25-32 x 0.312 inch
-182	337-0964-00	B010100	B049999X	1						1	SHIELD, light
-183	407-0281-00			1						1	BRACKET, circuit board, front
-	-			-						-	mounting hardware: (not included w/bracket)
-184	211-0101-00			1						1	SCREW, 4-40 x 0.25 inch, 100° csk, FHS
-185	407-0282-00			1						1	BRACKET, circuit board, rear
-	-			-						-	mounting hardware: (not included w/bracket)
-186	211-0101-00			1						1	SCREW, 4-40 x 0.25 inch, 100° csk, FHS
-187	670-0937-00			1						1	CIRCUIT BOARD ASSEMBLY CALIBRATOR A6
-	-			-						-	circuit board assembly includes:
-	388-1629-00			1						1	CIRCUIT BOARD
-188	131-0589-00			5						5	TERMINAL, pin, 0.50 inch long
-189	136-0220-00			3						3	SOCKET, transistor, 3 pin, square
-	-			-						-	mounting hardware: (not included w/circuit board assembly)
-190	211-0116-00			4						4	SCREW, sems, 4-40 x 0.312 inch, PHB

FIGURE 1 FRONT & CRT SHIELD (cont)

Fig. & Index No.	Tektronix Part No.	Serial/Model No. Eff	No. Disc	Q					Description	
				†	Y	1	2	3		4
1-191	211-0598-00			1						SCREW, captive, 6-32 x 0.375 inch, Fil HS
				-						mounting hardware: (not included w/screw)
-192	354-0163-00			1						RING, retaining
-193	210-0869-00			1						WASHER, plastic, 0.156 ID x 0.375 inch OD
-194	441-0688-01			1						CHASSIS, calibrator
				-						mounting hardware: (not included w/chassis)
-195	354-0165-00			1						RING, retaining
-196	214-0573-00			1						PIN, hinge
-197	210-0805-00			1						WASHER, flat, 0.204 ID x 0.438 inch OD
-198	179-1574-00			1						WIRING HARNESS, main
				-						wiring harness includes:
-199	131-0621-00			10						CONNECTOR, terminal
	131-0622-00			13						CONNECTOR, terminal
	131-0792-00			13						CONNECTOR, terminal
-200	352-0197-00			1						HOUSING, terminal connector, 1 wire (black)
-201	352-0198-00			12						HOUSING, terminal connector, 2 wire (black)
-202	352-0199-00			3						HOUSING, terminal connector, 3 wire (black)
-203	352-0201-00			1						HOUSING, terminal connector, 5 wire (black)
-204	179-1575-00	B010100	B089999	1						WIRING HARNESS, anode
	179-1575-02	B090000		1						WIRING HARNESS, anode
				-						wiring harness includes:
-205	131-0026-00			1						CONNECTOR, cable 0.562 inch OD
-206	200-0544-00			1						COVER, anode connector
-207	352-0199-00			1						HOLDER, terminal connector, 3 wire (black)
-208	131-0621-00			2						CONNECTOR, terminal
	131-0792-00			1						CONNECTOR, terminal
-209	179-1583-00			1						WIRING HARNESS, graticule

For Service Manuals Contact  
 MAURITRON TECHNICAL SERVICES  
 8 Cherry Tree Rd, Chalfont  
 Oxon OX9 4CY  
 Tel: 01644-351684 Fax: 01644-351684  
 Email: enquiries@mauratron.co.uk

FIG. 1 FRONT & CRT SHIELD

454A/R454A OSCILLOSCOPE

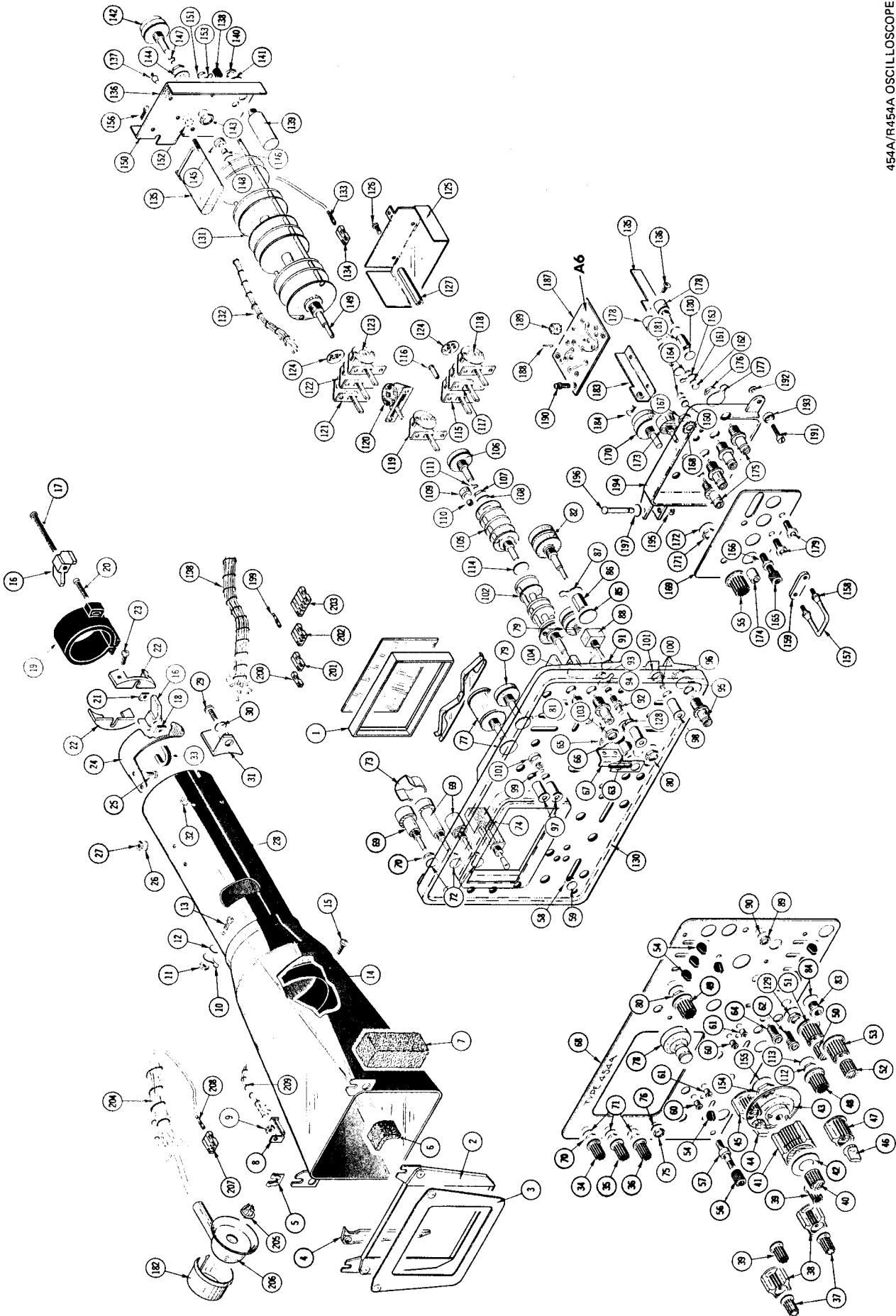

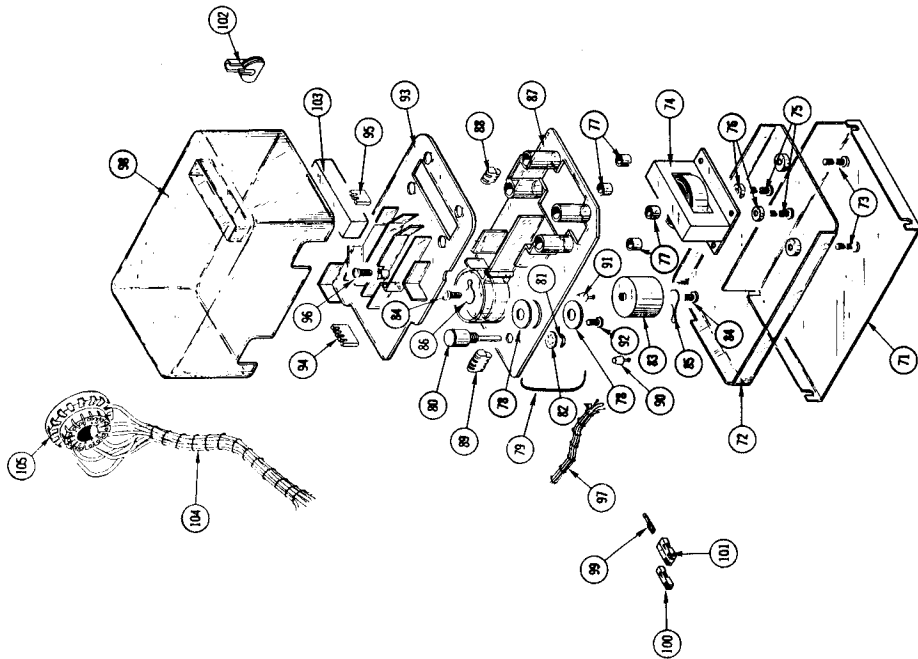

For Service Manuals Contact  
 MAURITON TECHNICAL SERVICES  
 8 Cherry Tree Rd, Salford  
 Oxon OX6 4QY  
 Tel: 01444-851094 Fax: 01444-851054  
 Email: enquiries@mauriton.co.uk

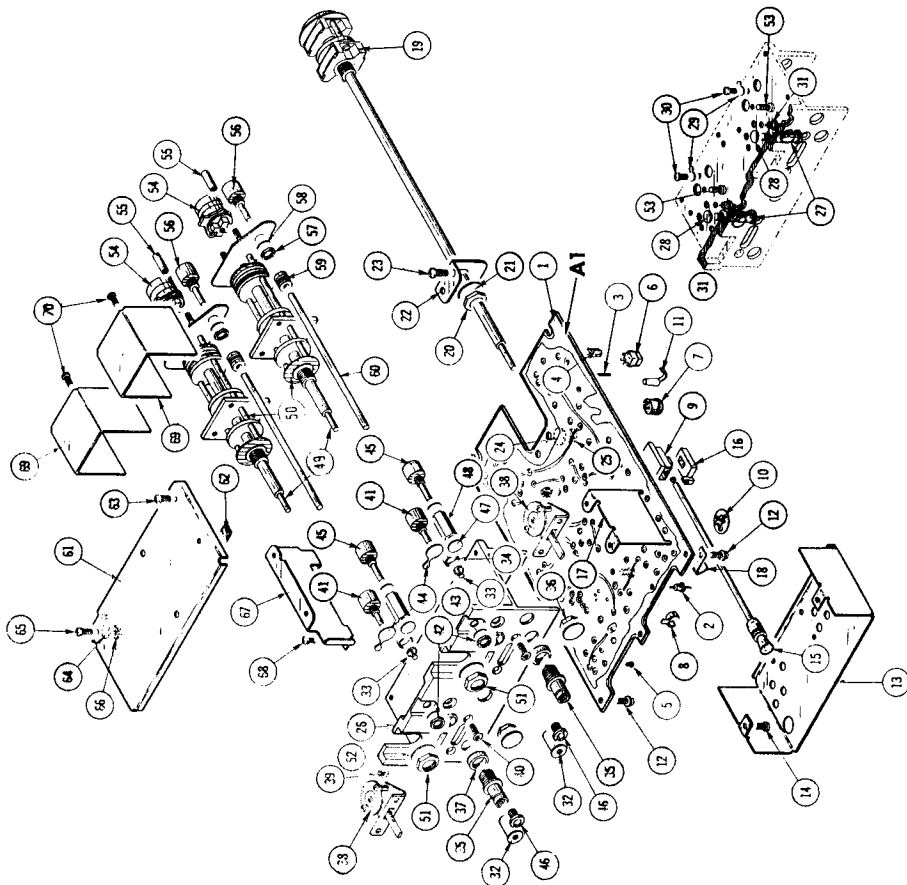

454A/R454A OSCILLOSCOPE

FIGURE 2 ATTENUATOR &amp; HIGH VOLTAGE

Fig. & Index No.	Tektronix Part No.	Serial/Model No.		Q t Y	Description
		Eff	Disc		
2-1	670-0943-00	B010100	B039999	1	CIRCUIT BOARD ASSEMBLY—VERTICAL PREAMP A1
	670-0943-02	B040000	B059999	1	CIRCUIT BOARD ASSEMBLY—VERTICAL PREAMP A1
	670-0943-04	B060000	B069999	1	CIRCUIT BOARD ASSEMBLY—VERTICAL PREAMP A1
	670-0943-01	B070000		1	CIRCUIT BOARD ASSEMBLY—VERTICAL PREAMP A1
	-----			-	circuit board assembly includes:
	388-1637-00			1	CIRCUIT BOARD
-2	131-0158-00			2	TERMINAL, feed-thru, 0.571 inch long
-3	131-0589-00			12	TERMINAL, pin, 0.50 inch long
-4	131-1003-00			2	RECEPTACLE, coaxial cable
-5	136-0252-01			12	SOCKET, pin connector, 0.178 inch long
-6	136-0220-00	B010100	B010649	26	SOCKET, transistor, 3 pin, square
	136-0220-00	B010650		22	SOCKET, transistor, 3 pin, square
	136-0219-00	B010650		4	SOCKET, transistor, 4 pin
-7	136-0235-00			2	SOCKET, transistor, 6 pin
-8	200-0642-00			1	CAP
-9	260-0723-00			1	SWITCH, slide—INVERT PULL
	-----			-	mounting hardware: (not included w/switch)
	343-0159-00			1	RETAINER, slide switch
	334-0227-00	B010100	B010650X	2	CLIP, grounding, dual transistor
-10	388-0839-00			2	CIRCUIT BOARD, T-coil
-11	343-0088-00			3	CLAMP, cable, snap-on, small
	-----			-	mounting hardware: (not included w/circuit board assembly)
-12	211-0116-00	B010100	B089999	6	SCREW, sems, 4-40 x 0.312 inch, PHB
	210-1001-00			4	WASHER, flat, 0.119 ID x 0.375 inch OD (not shown)
	210-0586-00	B010100	B089999	2	NUT, keps, 4-40 x 0.25 inch (not shown)
	211-0116-00	B090000		8	SCREW, sems, 4-40 x 0.312 inch, PHB
-13	337-1357-00			1	SHIELD, electrical
	-----			-	mounting hardware: (not included w/shield)
-14	211-0007-00			7	SCREW, 4-40 x 0.188 inch, PHS
-15	384-1037-01			1	ROD, extension, w/knob
-16	376-0062-00			1	COUPLING, slide switch to shaft
-17	337-1311-00			1	SHIELD, electrical, left
-18	131-1024-00			1	CONTACT, electrical, shaft grounding
-19	260-1147-00			1	SWITCH, rotary—MODE, unwired
	-----			-	mounting hardware: (not included w/switch)
-20	210-0590-00			1	NUT, hex., 0.375-32 x 0.438 inch
-21	210-0012-00			2	WASHER, lock, internal, 0.375 ID x 0.50 inch OD
-22	407-0774-00			1	BRACKET, switch
-23	211-0008-00			1	SCREW, 4-40 x 0.25 inch, PHS
-24	210-1001-00			1	WASHER, flat, 0.199 ID x 0.375 inch OD
-25	210-0586-00			1	NUT, keps, 4-40 x 0.25 inch



FIGURE 2 ATTENUATOR & HIGH VOLTAGE (cont)

Fig. & Index No.	Tektronix Part No.	Serial/Model No. Eff	No. Disc	Q					Description	
				†	y	1	2	3		4
2-26	426-0682-01			1						FRAME, attenuator
-27	- - - - -			4						CAPACITOR
				-						mounting hardware for each: <i>(not included w/capacitor)</i>
-28	210-0008-00			1						WASHER, lock, internal, 0.172 ID x 0.331 inch OD
-29	210-0259-00			2						LUG, solder, SE #2
	- - - - -			-						mounting hardware for each: <i>(not included w/lug)</i>
-30	211-0079-00			1						SCREW, 2-56 x 0.188 inch, PHS
-31	131-0158-00			6						TERMINAL, feed-thru, 0.571 inch long
-32	352-0084-00			2						HOLDER, neon, black
-33	378-0541-00			2						FILTER, lens, neon
-34	200-0609-00			2						COVER, neon holder
-35	131-0955-00			2						CONNECTOR, BNC, female, w/hardware
	- - - - -			-						mounting hardware for each: <i>(not included w/connector)</i>
-36	210-0590-00			1						NUT, hex., 0.375-32 x 0.438 inch
-37	361-0348-00			1						SPACER, ring, BNC, 0.50 inch ID
-38	260-1168-00			2						SWITCH, lever—AC-DC-GND (CH1 & CH2)
	- - - - -			-						mounting hardware for each: <i>(not included w/switch)</i>
-39	210-0586-00			2						NUT, keps, 4-40 x 0.25 inch
-40	211-0101-00			2						SCREW, 4-40 x 0.25 inch, 100° csk, FHS
-41	- - - - -			2						RESISTOR, variable
	- - - - -			-						mounting hardware for each: <i>(not included w/resistor)</i>
-42	210-0583-00			1						NUT, hex., 0.25-32 x 0.312 inch
-43	210-0940-00			1						WASHER, flat, 0.25 ID x 0.375 inch OD
-44	210-0223-00			1						LUG, solder, 0.25 ID x 0.438 inch OD, SE
-45	- - - - -			2						RESISTOR, variable
	- - - - -			-						mounting hardware for each: <i>(not included w/resistor)</i>
-46	358-0409-00			1						BUSHING, 0.25-32 x 0.247 inch long
-47	210-0046-00			2						WASHER, lock, internal, 0.25 ID x 0.40 inch OD
-48	210-0471-00			1						NUT, hex., stepped, 4-40 x 0.218 inch long

For Service Information Contact  
 MURKINTECH LTD  
 8 Cherry Tree Lane  
 Oxon OX2 0JZ  
 Tel: 01844-351834 Fax: 01844-351854  
 Email: enquiries@murkin.co.uk

FIGURE 2 ATTENUATOR & HIGH VOLTAGE (cont)

Fig. & Index No.	Tektronix Part No.	Serial/Model Eff	No. Disc	Q					Description	
				t	y	1	2	3		4
2-49	384-1013-00			1						SHAFT, extension, 5.52 inches long
-50	260-1190-00			2						SWITCH, rotary—VOLTS/DIV (CH1 & CH2), unwired
	- - - - -			-						mounting hardware for each: (not included w/switch)
-51	210-0590-00			1						NUT, hex., 0.375-32 x 0.438 inch
-52	210-0978-00			1						WASHER, flat, 0.375 ID x 0.50 inch OD
-53	211-0079-00			2						SCREW, 2-56 x 0.188 inch, PHS
-54	- - - - -			2						RESISTOR, variable
	- - - - -			-						mounting hardware for each: (not included w/resistor)
-55	220-0464-00			2						NUT, round, 2-56 x 0.438 inch long
-56	- - - - -			2						RESISTOR, variable
	- - - - -			-						mounting hardware for each: (not included w/resistor)
-57	210-0583-00			1						NUT, hex., 0.25-32 x 0.312 inch
-58	210-0046-00			1						WASHER, lock, internal, 0.25 ID x 0.40 inch OD
-59	376-0051-00			2						COUPLING ASSEMBLY
	- - - - -			-						each coupling assembly includes:
	213-0022-00			4						SETSCREW, 4-40 x 0.188 inch, HSS
	376-0049-00			1						COUPLING, plastic
	354-0251-00			2						RING, coupling
-60	384-1034-00			2						SHAFT, extension, 3.14 inches long
-61	337-1356-00			1						SHIELD, electrical
	- - - - -			-						shield includes:
-62	342-0062-00			2						INSULATOR, plate, plastic
	- - - - -			-						mounting hardware: (not included w/shield)
-63	211-0007-00			4						SCREW, 4-40 x 0.188 inch, PHS
-64	210-0201-00			1						LUG, solder, SE #4
	- - - - -			-						mounting hardware: (not included w/lug)
-65	211-0007-00			1						SCREW, 4-40 x 0.188 inch, PHS
-66	210-0586-00			1						NUT, hex., 4-40 x 0.25 inch
-67	337-1361-00			1						SHIELD, electrical, attenuator
	- - - - -			-						mounting hardware: (not included w/shield)
-68	211-0007-00			1						SCREW, 4-40 x 0.188 inch, PHS
	211-0116-00			1						SCREW, sems, 4-40 x 0.312 inch, PHB
-69	337-1355-00			2						SHIELD, electrical, attenuator
	- - - - -			-						mounting hardware for each: (not included w/shield)
-70	211-0079-00			4						SCREW, 2-56 x 0.188 inch, PHS

FIGURE 2 ATTENUATOR & HIGH VOLTAGE (cont)

Fig. & Index No.	Tektronix Part No.	Serial/Model Eff	No. Disc	Q					Description
				y	1	2	3	4	
2-71	337-0875-02			1					SHIELD, high voltage box
	- - - - -			-					mounting hardware: <i>(not included w/shield)</i>
	211-0503-00			3					SCREW, 6-32 x 0.188 inch, PHS <i>(not shown)</i>
-72	200-0708-00			1					COVER, high voltage box, plastic
	- - - - -			-					mounting hardware: <i>(not included w/cover)</i>
-73	211-0552-00			2					SCREW, 6-32 x 2 inches, PHS
	621-0452-00	B010100	B099999	1					HIGH VOLTAGE ASSEMBLY
	621-0452-01	B100000		1					HIGH VOLTAGE ASSEMBLY
	- - - - -			-					high voltage assembly includes:
-74	- - - - -			1					TRANSFORMER
	- - - - -			-					mounting hardware: <i>(not included w/transformer)</i>
-75	211-0530-00			2					SCREW, 6-32 x 1.75 inches, PHS
-76	210-0869-00			2					WASHER, plastic, 0.156 ID x 0.375 inch OD
-77	358-0231-00			4					BUSHING, insulating
-78	210-0966-00			4					WASHER, insulating, 0.312 ID x 0.875 inch OD
-79	346-0032-00			1					STRAP, mouse tail
-80	- - - - -			1					RESISTOR, variable
	- - - - -			-					mounting hardware: <i>(not included w/resistor)</i>
-81	210-0583-00			1					NUT, hex., 0.25-32 x 0.312 inch
-82	210-0046-00			1					WASHER, lock, internal, 0.25 ID x 0.40 inch OD
-83	- - - - -			1					CAPACITOR
	- - - - -			-					mounting hardware: <i>(not included w/capacitor)</i>
-84	211-0503-00			2					SCREW, 6-32 x 0.188 inch, PHS
-85	210-0203-00			1					LUG, solder, SE #6, long
-86	210-0202-00			1					LUG, solder, SE #6
-87	441-0693-00			1					CHASSIS, high voltage, plastic
	- - - - -			-					chassis includes:
-88	124-0163-00			6					TERMINAL STRIP, ceramic, 0.438 inch h, w/2 notches
-89	124-0164-00			4					TERMINAL STRIP, ceramic, 0.438 inch h, w/4 notches
-90	131-0227-00			2					CONNECTOR, terminal, stand off
	- - - - -			-					mounting hardware for each: <i>(not included w/connector)</i>
	358-0176-00			1					BUSHING, plastic
-91	131-0359-00			1					CONNECTOR, terminal, feed-thru
	- - - - -			-					mounting hardware: <i>(not included w/connector)</i>
	358-0176-00			1					BUSHING, plastic
	- - - - -			-					mounting hardware: <i>(not included w/chassis)</i>
-92	211-0558-00			1					SCREW, 6-32 x 0.25 inch, BH plastic
-93	392-0169-00			1					BOARD, high voltage, plastic
	- - - - -			-					board includes:
-94	124-0176-00			2					TERMINAL STRIP, ceramic, 0.438 inch h, w/4 notches
-95	124-0175-00			4					TERMINAL STRIP, ceramic, 0.438 inch h, w/2 notches
	- - - - -			-					mounting hardware: <i>(not included w/board)</i>
-96	211-0036-00			1					SCREW, 4-40 x 0.50 inch, BH plastic

FIGURE 2 ATTENUATOR & HIGH VOLTAGE (cont)

Fig. & Index No.	Tektronix Part No.	Serial/Model Eff	No. Disc	Q					Description	
				Y	1	2	3	4		5
2-97	179-1580-00			1						WIRING HARNESS, high voltage #1
	179-1143-00			1						WIRING HARNESS, high voltage #2
-98	380-0108-00			1						HOUSING, high voltage, plastic
-99	131-0621-00			3						CONNECTOR, terminal
-100	352-0197-00			1						HOLDER, terminal connector, 1 wire (black)
-101	352-0198-00			2						HOLDER, terminal connector, 2 wire (black)
	- - - - -			-						mounting hardware: (not included w/high voltage assembly)
	211-0504-00			3						SCREW, 6-32 x 0.25 inch, PHS (not shown)
-102	166-0368-00			1						SLEEVE, anode
-103	381-0243-00			1						BAR, heat sink
-104	136-0420-00			1						WIRING HARNESS, CRT socket
	- - - - -			-						wiring harness includes:
-105	136-0202-01			1						SOCKET, CRT, w/pins

For Service Manuals Contact  
 MATEC INTERNATIONAL LTD  
 8 Church Lane, Borehamwood  
 Oxon OX9 3DQ  
 Tel: 01844-351311  
 Email: enquiries@matec.co.uk

FIGURE 3 CHASSIS

Fig. & Index No.	Tektronix Part No.	Serial/Model No.		Q t y	Description
		Eff	Disc		
3-1	670-0941-00	B010100	B010499	1	CIRCUIT BOARD ASSEMBLY—A SWEEP A4
	670-0941-01	B010500	B019999	1	CIRCUIT BOARD ASSEMBLY—A SWEEP A4
	670-0941-02	B020000	B039999	1	CIRCUIT BOARD ASSEMBLY—A SWEEP A4
	670-0941-04	B040000	B079999	1	CIRCUIT BOARD ASSEMBLY—A SWEEP A4
	670-0941-03	B080000		1	CIRCUIT BOARD ASSEMBLY—A SWEEP A4
	- - - - -			-	circuit board assembly includes:
	388-1633-00			1	CIRCUIT BOARD
-2	131-0589-00			58	TERMINAL, pin, 0.50 inch long
-3	136-0183-00			1	SOCKET, transistor, 3 pin
-4	136-0235-00			1	SOCKET, transistor, 6 pin
-5	136-0220-00	B010100	B019999	31	SOCKET, transistor, 3 pin, square
	136-0220-00	B020000		29	SOCKET, transistor, 3 pin, square
	136-0352-00	B020000		5	SOCKET, pin connector
-6	214-0579-00			8	PIN, test point
-7	214-0565-00			3	FASTENER, pin, press
-8	337-0763-00			1	SHIELD, circuit board
-9	337-1301-00			1	SHIELD, electrical, right
-10	337-1302-00			1	SHIELD, electrical, left
-11	211-0155-00			5	SCREW, relieved body, 4-40 x 0.22 inch long
-12	361-0238-00			3	SPACER, sleeve, 0.34 inch long
-13	361-0301-00			2	SPACER, sleeve, 0.105 inch long
-14	343-0089-00			3	CLAMP, cable, snap-on, large
-15	337-1303-00			1	SHIELD, electrical, bottom
	- - - - -			-	mounting hardware: (not included w/shield)
-16	211-0007-00			4	SCREW, 4-40 x 0.188 inch, PHS
-17	670-0942-00	B010100	B010499	1	CIRCUIT BOARD ASSEMBLY—B SWEEP A5
	670-0942-01	B010500	B019999	1	CIRCUIT BOARD ASSEMBLY—B SWEEP A5
	670-0942-02	B020000	B079999	1	CIRCUIT BOARD ASSEMBLY—B SWEEP A5
	670-0942-03	B080000	B089999	1	CIRCUIT BOARD ASSEMBLY—B SWEEP A5
	670-0942-06	B090000		1	CIRCUIT BOARD ASSEMBLY—B SWEEP A5
	- - - - -			-	circuit board assembly includes:
	388-1634-00			1	CIRCUIT BOARD
-18	131-0589-00			63	TERMINAL, pin, 0.50 inch long
-19	136-0183-00			4	SOCKET, transistor, 3 pin
-20	136-0235-00			2	SOCKET, transistor, 6 pin
-21	136-0220-00			37	SOCKET, transistor, 3 pin, square
-22	214-0579-00			13	PIN, test point
-23	214-0565-00			1	FASTENER, pin, press
-24	214-0668-00			2	HEAT SINK, transistor
-25	337-0764-00			1	SHIELD, electrical
-26	337-0896-00			1	SHIELD, electrical
-27	211-0155-00			4	SCREW, relieved body, 4-40 x 0.22 inch long
-28	361-0238-00			4	SPACER, sleeve, 0.34 inch long
	- - - - -			-	mounting hardware: (not included w/circuit board assembly)
-29	211-0116-00			2	SCREW, sems, 4-40 x 0.312 inch, PHB
	337-1536-00	XB090000		1	SHIELD, electrical, horizontal amp. input
	214-1042-00	XB090000		1	SPRING, helical compression
-30	407-0758-00			1	BRACKET, capacitor
	- - - - -			-	mounting hardware: (not included w/bracket)
-31	211-0504-00			5	SCREW, 6-32 x 0.25 inch, PHS
-32	343-0007-00			1	CLAMP, cable, plastic, 0.625 inch diameter
	- - - - -			-	mounting hardware: (not included w/clamp)
-33	211-0510-00			1	SCREW, 6-32 x 0.375 inch, PHS
-34	210-0863-00			1	WASHER, D-shape, 0.191 ID x 0.515 inch
-35	210-0457-00			1	NUT, keps, 6-32 x 0.312 inch

FIGURE 3 CHASSIS (cont)

Fig. & Index No.	Tektronix Part No.	Serial/Model No. Eff	No. Disc	Q					Description	
				t	y	1	2	3		4
3-36	124-0119-00			2						TERMINAL STRIP, ceramic, 0.438 inch h, w/2 notches
-	-			-						each terminal strip includes:
	355-0046-00			1						STUD, plastic
	-			-						mounting hardware for each: <i>(not included w/terminal strip)</i>
	361-0007-00			1						SPACER, plastic, 0.156 inch long
-37	124-0147-00			4						TERMINAL STRIP, ceramic, 0.438 inch h, w/13 notches
-	-			-						each terminal strip includes:
	355-0046-00			2						STUD, plastic
	-			-						mounting hardware for each: <i>(not included w/terminal strip)</i>
	361-0007-00			2						SPACER, plastic, 0.156 inch long
-38	200-0256-00			2						COVER, capacitor, plastic, 1 inch diameter
-39	-			2						CAPACITOR
-	-			-						mounting hardware for each: <i>(not included w/capacitor)</i>
-40	211-0588-00			2						SCREW, 6-32 x 0.75 inch, HHS
-41	432-0047-00			1						BASE, plastic, small
-42	386-0252-00			1						PLATE, fiber, small
-43	210-0457-00			2						NUT, keps, 6-32 x 0.312 inch
-44	200-0538-00			2						COVER, capacitor, plastic, 1.365 inches diameter
-45	-			2						CAPACITOR
-	-			-						mounting hardware for each: <i>(not included w/capacitor)</i>
-46	211-0588-00			2						SCREW, 6-32 x 0.75 inch, HHS
-47	432-0048-00			1						BASE, plastic, large
-48	386-0254-00			1						PLATE, fiber, large
-49	210-0457-00			2						NUT, keps, 6-32 x 0.312 inch
-50	179-1576-00			1						WIRING HARNESS, CAPACITOR bracket
-	-			-						wiring harness includes:
-51	131-0621-00			12						CONNECTOR, terminal
-52	352-0202-00			2						HOLDER, terminal connector, 6 wire <i>(black)</i>
-53	343-0089-00			2						CLAMP, cable, snap-on, large
	119-0242-00			1						DELAY LINE ASSEMBLY
-	-			-						delay line assembly includes:
-54	200-1113-00			1						COVER, delay line, top
-55	358-0007-00			2						BUSHING, hex., 0.375-32 x 0.406 inch
-	-			-						mounting hardware for each: <i>(not included w/bushing)</i>
-56	211-0538-00			2						SCREW, 6-32 x 0.312 inch, 100° csk, FHS
-57	129-0278-00			2						POST, hex., 6-32 x 0.25 x 1.11 inches long
-	-			-						mounting hardware for each: <i>(not included w/post)</i>
-58	211-0538-00			1						SCREW, 6-32 x 0.312 inch, 100° csk, FHS
-59	129-0264-00			2						POST, plastic, 0.75 OD x 1.1 inches long
-	-			-						mounting hardware for each: <i>(not included w/post)</i>
-60	213-0068-00			2						SCREW, thread forming, 6-32 x 0.312 inch, 100° csk, FHS

For Service Manuals Contact  
 MARLBOROUGH TECHNICAL SERVICES  
 8 Cherry Tree Road, Marlborough  
 Oxon OX20 4DY  
 Tel: 01844-331034 Fax: 01844-331034  
 Email: enquiries@mcquinn.co.uk

FIGURE 3 CHASSIS (cont)

Fig. & Index No.	Tektronix Part No.	Serial/Model Eff	No. Disc	Q					Description
				Y	1	2	3	4	
3-61	407-0859-00			1					BRACKET, terminal
-62	211-0008-00			-					mounting hardware: <i>(not included w/bracket)</i>
-63	210-0586-00			1					SCREW, 4-40 x 0.25 inch, PHS
				1					NUT, keps, 4-40 x 0.25 inch, PHS
-64	131-0309-00			2					CONNECTOR, terminal, 0.415 inch long
-65	358-0241-00			-					mounting hardware for each: <i>(not included w/connector)</i>
				1					BUSHING, plastic
	200-0114-00			1					COVER, delay line bottom
-66	210-0775-00			2					EYELET, 0.23 inch long
	210-0774-00			2					EYELET, 0.218 inch long
-67	131-1002-00			1					CONNECTOR, delay line
-68	361-0360-00	B010100	B089999X	1					SPACER, sleeve, 0.125 ID x 0.312 OD x 0.143 inch long
-69	361-0361-00	B010100	B089999X	1					SPACER, sleeve, 0.125 ID x 0.312 OD x 0.103 inch long
				-					mounting hardware: <i>(not included w/delay line assembly)</i>
-70	210-0457-00			1					NUT, keps, 6-32 x 0.312 inch
-71	211-0510-00			3					SCREW, 6-32 x 0.375 inch, PHS
-72	407-0773-00			1					BRACKET, circuit board
-73	252-0571-00			-					bracket includes:
				ft					EXTRUSION, plastic, 0.208 foot
				-					mounting hardware: <i>(nt included w/bracket)</i>
	211-0504-00			2					SCREW, 6-32 x 0.25 inch, PHS <i>(not shown)</i>
-74	214-0982-00			2					SPRING, grounding
-75	211-0007-00			-					mounting hardware for each: <i>(not included w/spring)</i>
				1					SCREW, 4-40 x 0.188 inch, PHS
-76	131-0157-00			2					CONNECTOR, terminal, standoff
-77	131-0158-00			2					CONNECTOR, terminal, feed-thru
-78	441-0942-00			1					CHASSIS, center
				-					mounting hardware: <i>(not included w/chassis)</i>
	212-0001-00			1					SCREW, 8-32 x 0.25 inch, PHS <i>(not shown)</i>
	210-0457-00			1					NUT, keps, 6-32 x 0.312 inch <i>(not shown)</i>
-79	407-0775-00			1					BRACKET, angle, vertical amplifier
				-					mounting hardware: <i>(not included w/bracket)</i>
	211-0510-00			2					SCREW, 6-32 x 0.375 inch, PHS <i>(not shown)</i>
-80	211-0504-00			1					SCREW, 6-32 x 0.25 inch, PHS
-81	210-0802-00			1					WASHER, flat, 0.15 ID x 0.375 inch OD
-82	210-0202-00			1					LUG, solder, SE #6
				-					mounting hardware: <i>(not included w/lug)</i>
-83	211-0504-00			1					SCREW, 6-32 x 0.25 inch, PHS

FIGURE 3 CHASSIS (cont)

Fig. & Index No.	Tektronix Part No.	Serial/Model Eff	No. Disc	Q † y	Description	Q				
						1	2	3	4	5
3-84	214-1186-00			2	PIN, hinge, plastic					
	- - - - -			-	mounting hardware for each: <i>(not included w/pin)</i>					
-85	211-0102-00			2	SCREW, 4-40 x 0.50 inch, 100° csk, FHS					
-86	210-0230-00			2	LUG, spade, #6					
-87	210-0586-00			2	NUT, keps, 4-40 x 0.25 inch					
-88	670-0939-00	B010100	B029999	1	CIRCUIT BOARD ASSEMBLY—VERTICAL OUTPUT A2					
	670-0939-01	B030000		1	CIRCUIT BOARD ASSEMBLY—VERTICAL OUTPUT A2					
	- - - - -			-	circuit board assembly includes:					
	388-1631-00			1	CIRCUIT BOARD					
-89	131-0589-00			11	TERMINAL, pin, 0.50 inch long					
-90	136-0252-00			41	SOCKET, pin, connector					
	136-0352-00			4	SOCKET, pin, connector					
-91	388-0867-01	B010100	B030000X	2	CIRCUIT BOARD, T-coil					
-92	211-0155-00			3	SCREW, relieved body, 4-40 x 0.22 inch long					
-93	361-0301-00			3	SPACER, sleeve, 0.105 inch long					
-94	131-0183-00			1	CONNECTOR, terminal, feed-thru					
	131-0181-00			1	CONNECTOR, terminal, standoff					
-95	210-0201-00			5	LUG, solder, SE #4					
	- - - - -			-	mounting hardware for each: <i>(not included w/lug)</i>					
96	210-0406-00			1	NUT, hex., 4-40 x 0.188 inch					
-97	210-0202-00			1	LUG, solder, SE #6					
	- - - - -			-	mounting hardware: <i>(not included w/lug)</i>					
-98	211-0504-00			1	SCREW, 6-32 x 0.25 inch, PHS					
-99	210-0407-00			1	NUT, hex., 6-32 x 0.25 inch					
-100	352-0100-00			2	HOLDER, variable resistor					
	- - - - -			-	mounting hardware for each: <i>(not included w/holder)</i>					
-101	361-0007-00			1	SPACER, plastic, 0.156 inch long					
	- - - - -			1	HYBRID CIRCUIT A3 (see electrical parts list)					
	- - - - -			-	hybrid circuit includes:					
-102	352-0246-00			1	HOLDER, transistor, plastic					
	- - - - -			-	mounting hardware: <i>(not included w/holder)</i>					
-103	211-0143-00			1	SCREW, 4-40 x 0.375 inch, PHS					
-104	210-0994-00			1	WASHER, flat, 0.125 ID x 0.25 inch OD					
	210-0906-00			1	WASHER, fiber, 0.125 ID x 0.203 inch OD					
-105	211-0116-00			4	SCREW, sems, 4-40 x 0.312 inch, PHB					
-106	210-1124-00			4	WASHER, spring tension, 171 ID x 0.562 inch OD					
	210-1123-00			4	WASHER, flat, 0.168 ID x 0.593 inch OD					
-107	131-0433-00			2	TERMINAL, stud					
	- - - - -			-	mounting hardware for each: <i>(not included w/terminal)</i>					
	358-0241-00			1	BUSHING, plastic					

For Service Manuals Contact  
**MAURITRON TECHNICAL SERVICES**  
 8 Cherry Tree Way, Gillingham  
 Oxon OX9 4GY  
 Tel: 01044-651041 Fax: 01044-651054  
 Email: enquiries@mauratron.co.uk



FIGURE 3 CHASSIS (cont)

Fig. & Index No.	Tektronix Part No.	Serial/Model No. Eff	No. Disc	Q					Description	
				t	y	1	2	3		4
3-108	441-0940-00			1						CHASSIS
-109	211-0504-00			-						mounting hardware: <i>(not included w/hybrid circuit)</i>
-110	211-0510-00			5						SCREW, 6-32 x 0.25 inch, PHS
-111	210-0863-00			1						SCREW, 6-32 x 0.375 inch, PHS
-112	343-0001-00			1						WASHER, D-shape, 0.191 ID x 0.515 inch
-113	210-0457-00			1						CLAMP, cable, plastic, 0.125 inch diameter
				6						NUT, keps, 6-32 x 0.312 inch
-114	441-0938-00			1						CHASSIS, swing out
				-						mounting hardware: <i>(not included w/chassis)</i>
-115	211-0504-00			1						SCREW, 6-32 x 0.25 inch, PHS
-116	348-0056-00			2						GROMMET, plastic, 0.375 inch diameter
-117	255-0334-00			ft						PLASTIC CHANNEL, 1 each lengths 1 & 2 inches
-118	386-1780-00			1						SUPPORT, chassis
-119				1						CAPACITOR
				-						mounting hardware: <i>(not included w/capacitor)</i>
-120	210-0457-00			2						NUT, keps, 6-32 x 0.312 inch
-121	210-0202-00			1						LUG, solder, SE #6
				-						mounting hardware: <i>(not included w/lug)</i>
-122	210-0407-00			1						NUT, hex., 6-32 x 0.25 inch
-123	343-0013-00			3						CLAMP, cable, plastic, 0.375 inch diameter
				-						mounting hardware for each: <i>(not included w/clamp)</i>
-124	210-0457-00			1						NUT, keps, 6-32 x 0.312 inch
-125	210-0863-00			1						WASHER, D-shape, 0.191 ID x 0.515 inch
-126	348-0031-00			1						GROMMET, plastic, 0.156 inch diameter
-127	202-0142-01			1						BOX, high voltage
				-						mounting hardware: <i>(not included w/box)</i>
-128	211-0504-00			4						SCREW, 6-32 x 0.25 inch, PHS
-129	352-0031-00			2						HOLDER, fuse, single
				-						mounting hardware for each: <i>(not included w/holder)</i>
-130	210-0406-00			2						NUT, hex., 4-40 x 0.188 inch
-131	210-0054-00			2						WASHER, split, 0.118 ID x 0.212 inch OD
-132				1						TRANSFORMER
				-						transformer includes:
-133	407-0741-00			1						BRACKET, component mounting
-134	343-0267-00			2						HOLD-DOWN, bracket
-135	212-0099-00			4						SCREW, 8-32 x 0.50 inch, HHS
-136	210-0409-00	B010100	B010439	4						NUT, hex., 8-32 x 0.312 inch
	210-0458-00	B010440		4						NUT, keps, 8-32 x 0.344 inch

FIGURE 3 CHASSIS (cont)

Fig. & Index No.	Tektronix Part No.	Serial/Model No. Eff	No. Disc	Q					Description
				y	1	2	3	4	
				-					mounting hardware: <i>(not included w/transformer)</i>
3-137	212-0001-00			3					SCREW, 8-32 x 0.25 inch, PHS
-138	210-0206-00			1					LUG, solder, SE #10, long
	212-0004-00			1					SCREW, 8-32 x 0.312 inch, PHS
-139	670-0940-00			1					CIRCUIT BOARD ASSEMBLY—Z AXIS A8
				-					circuit board assembly includes
	388-1632-00			1					CIRCUIT BOARD
-140	131-0589-00			20					TERMINAL, pin, 0.50 inch long
-141	136-0183-00			5					SOCKET, transistor, 3 pin
-142	136-0220-00			3					SOCKET, transistor, 3 pin, square
-143	214-0579-00			3					PIN, test point
-144	361-0301-00			2					SPACER, sleeve, 0.105 inch long
-145	211-0155-00			2					SCREW, relieved body, 4-40 x 0.22 inch long
				-					mounting hardware: <i>(not included w/circuit board assembly)</i>
-146	211-0116-00			1					SCREW, sems, 4-40 x 0.312 inch, PHB
-147	670-0938-00			1					CIRCUIT BOARD ASSEMBLY—LOW VOLTAGE REG A7
				-					circuit board assembly includes:
	388-1630-00			1					CIRCUIT BOARD
-148	131-0787-00			12					TERMINAL, pin, 0.64 inch long
-149	136-0220-00			8					SOCKET, transistor, 3 pin, square
-150	214-0579-00			3					PIN, test point
				-					mounting hardware: <i>(not included w/circuit board assembly)</i>
-151	211-0116-00			3					SCREW, sems, 4-40 x 0.312 inch, PHB
-152	441-0691-04			1					CHASSIS, low voltage regulator
				-					mounting hardware: <i>(not included w/chassis)</i>
-153	211-0510-00			1					SCREW, 6-32 x 0.375 inch, PHS
-154	211-0504-00			2					SCREW, 6-32 x 0.25 inch, PHS
-155	210-0457-00			2					NUT, keps, 6-32 x 0.312 inch, PHS
-156				4					TRANSISTOR
				-					mounting hardware for each: <i>(not included w/transistor)</i>
-157	211-0510-00			2					SCREW, 6-32 x 0.375 inch, PHS
-158	387-0345-00			1					PLATE, insulator
-159	210-0811-00			2					WASHER, fiber, shouldered, #6
-160	210-0802-00			2					WASHER, flat, 0.15 ID x 0.312 inch OD
-161	210-0006-00			1					WASHER, lock, internal, 0.146 ID x 0.283 inch OD
-162	210-0202-00			1					LUG, solder, SE #6
-163	210-0407-00			2					NUT, hex., 6-32 x 0.25 inch
-164	214-0289-00			2					HEAT SINK, transistor
				-					mounting hardware for each: <i>(not included w/heat sink)</i>
-165	220-0410-00			1					NUT, keps, 10-32 x 0.375 inch
-166	210-0805-00			1					WASHER, flat, 0.204 ID x 0.438 inch OD
-167	210-0909-00			2					WASHER, mica, 0.196 ID x 0.625 inch OD

For Service Manuals Contact  
 MAURITRON TECHNICAL SERVICE  
 8 Cherry Tree Hill, Cranford  
 Oxon OX9 4G Y  
 Tel: 01044-351634 Fax: 01044-351634  
 Email: enquiries@mauritron.co.uk

FIGURE 3 CHASSIS (cont)

Fig. & Index No.	Tektronix Part No.	Serial/Model Eff	No. Disc	Q					Description		
				t	y	1	2	3		4	5
3-168	124-0147-00			1						1	TERMINAL STRIP, ceramic, 0.438 inch h, w/13 notches
	- - - - -			-							terminal strip includes:
	355-0046-00			2							STUD, plastic
	- - - - -			-							mounting hardware: (not included w/terminal strip)
	361-0007-00			2							SPACER, plastic, 0.156 inch long
-169	407-0742-00			1							BRACKET, chassis, low voltage regulator
	- - - - -			-							mounting hardware: (not included w/bracket)
-170	211-0504-00			2							SCREW, 6-32 x 0.25 inch, PHS
-171	210-0802-00			1							WASHER, flat, 0.15 ID x 0.312 inch OD
-172	407-0857-00			1							BRACKET, support, swing out chassis
	- - - - -			-							mounting hardware: (not included w/bracket)
-173	211-0008-00			2							SCREW, 4-40 x 0.25 inch, PHS
-174	210-0586-00			2							NUT, keps, 4-40 x 0.25 inch
-175	- - - - -			1							RESISTOR, variable
	- - - - -			-							mounting hardware: (not included w/resistor)
-176	210-0583-00			1							NUT, hex., 0.25-32 x 0.312 inch
-177	210-0940-00			1							WASHER, flat, 0.25 ID x 0.375 inch OD
-178	210-0223-00			1							LUG, solder, 0.25 ID x 0.438 inch OD, SE
-179	358-0215-00			2							BUSHING, plastic
-180	348-0064-00			2							GROMMET, plastic, 0.625 inch diameter
-181	348-0063-00			4							GROMMET, plastic, 0.50 inch diameter
-182	348-0055-00			2							GROMMET, plastic, 0.25 inch diameter
-183	344-0120-00			1							CLIP, plastic
	- - - - -			-							mounting hardware: (not included w/clip)
-184	213-0055-00			1							SCREW, thread forming, 2-32 x 0.188 inch, PHS
-185	343-0013-00			1							CLAMP, cable, 0.375 inch diameter
	- - - - -			-							mounting hardware: (not included w/clamp)
-186	210-0507-00			1							SCREW, 6-32 x 0.312 inch, PHS
-187	210-0863-00			1							WASHER, D-shape, 0.191 ID x 0.515 inch
-188	214-0210-00			1							SOLDER SPOOL ASSEMBLY
	- - - - -			-							solder spool assembly includes:
	214-0209-00			1							SPOOL, solder
	- - - - -			-							mounting hardware: (not included w/solder spool assembly)
-189	361-0007-00			1							SPACER, plastic, 0.156 inch long
-190	- - - - -			1							THERMO CUTOUT
	- - - - -			-							mounting hardware: (not included w/thermo cutout)
-191	213-0044-00			2							SCREW, thread forming, 5-32 x 0.188 inch, PHS
	210-0201-00			1							LUG, solder, SE #4

## FIGURE 3 CHASSIS (cont)

Fig. & Index No.	Tektronix Part No.	Serial/Model Eff	No. Disc	Q † y						Description
					1	2	3	4	5	
3-192	210-0201-00			3						LUG, solder, SE #4
-193	213-0044-00			2						mounting hardware for each: (not included w/lug) SCREW, thread forming, 5-32 x 0.188 inch, PHS
-194	380-0114-00	B010100	B049999	1						HOUSING, air flow
	337-1505-00	B050000		1						SHIELD, fan motor
	635-0433-00			1						FAN MOTOR ASSEMBLY
										fan motor assembly includes:
-195	147-0027-00	B010100	B049999	1						MOTOR, fan
	147-0033-01	B050000		1						MOTOR, fan
-196	369-0025-00			1						IMPELLER, fan
										impeller includes:
	213-0126-00			1						SETSCREW, 6-32 x 0.25 inch, HSS
-197	407-0308-02			1						BRACKET, fan motor
										mounting hardware: (not included w/bracket)
-198	211-0097-00	B010100	B049999	3						SCREW, 4-40 x 0.375 inch, PHS
	211-0158-00	B050000		3						SCREW, 4-40 x 0.25 inch, PHS
	210-0054-00	B010100	B049999	3						WASHER, lock, split, 0.118 x 0.212 inch OD
	210-0004-00	B050000		3						WASHER, lock, internal, 0.12 ID x 0.26 inch OD
-199	131-0759-00			1						TERMINAL, lug
										mounting hardware: (not included w/fan motor assembly)
-200	211-0012-00			3						SCREW, 4-40 x 0.375 inch, PHS
-201	210-0851-00			6						WASHER, flat, 0.119 ID x 0.375 inch OD
-202	348-0093-00			3						GROMMET, 0.14 ID x 0.375 inch OD
-203	220-0471-00			3						NUT, stepped, round, 4-40 x 0.217 inch long
-204	124-0147-00			1						TERMINAL STRIP, ceramic, 0.438 inch h, w/13 notches
										terminal strip includes:
	355-0046-00			2						STUD, plastic
										mounting hardware: (not included w/terminal strip)
	361-0007-00			2						SPACER, plastic, 0.156 inch long
-205	124-0145-00			2						TERMINAL STRIP, ceramic, 0.438 inch h, w/20 notches
										each terminal strip includes:
	355-0046-00			2						STUD, plastic
										mounting hardware for each: (not included w/terminal strip)
	361-0007-00			2						SPACER, plastic, 0.156 inch long
-206	441-0690-00			1						CHASSIS, rear
										mounting hardware: (not included w/chassis)
	212-0004-00			4						SCREW, 8-32 x 0.312 inch, PHS (not shown)

For Service Manuals Contact  
 MAINTENANCE DEPARTMENT  
 8000 E. 1st Avenue  
 Denver, CO 80231  
 Tel: 303-440-1000  
 Email: [crp@tek.com](mailto:crp@tek.com)

FIGURE 3 CHASSIS (cont)

Fig. & Index No.	Tektronix Part No.	Serial/Model Eff	No. Disc	Q					Description	
				Y	1	2	3	4		5
3-207	179-1573-00			1						WIRING HARNESS, sweep
				-						wiring harness includes:
-208	131-0621-00			47						CONNECTOR, terminal
	131-0622-00			17						CONNECTOR, terminal
	131-0792-00			16						CONNECTOR, terminal
-209	352-0197-00			7						HOLDER, terminal connector, 1 wire (black)
-210	352-0198-00			7						HOLDER, terminal connector, 2 wire (black)
-211	352-0199-00			6						HOLDER, terminal connector, 3 wire (black)
-212	352-0200-00			4						HOLDER, terminal connector, 4 wire (black)
-213	352-0201-00			3						HOLDER, terminal connector, 5 wire (black)
-214	352-0205-00			1						HOLDER, terminal connector, 9 wire (black)
	179-1578-00			1						WIRING HARNESS, vertical output
				-						wiring harness includes:
	131-0621-00			5						CONNECTOR, terminal
	352-0201-00			1						HOUSING, terminal connector, 5 wire (black)
	179-1528-00			1						WIRING HARNESS, transformer

For Service Manuals Contact  
**MAGNETIC DATA CORPORATION**  
 8 Cherry Tree Lane  
 Oxford, MA 01461  
 Tel: 01044-5510-1000  
 Email: enquiries@magnetics.com

FIG. 3 CHASSIS

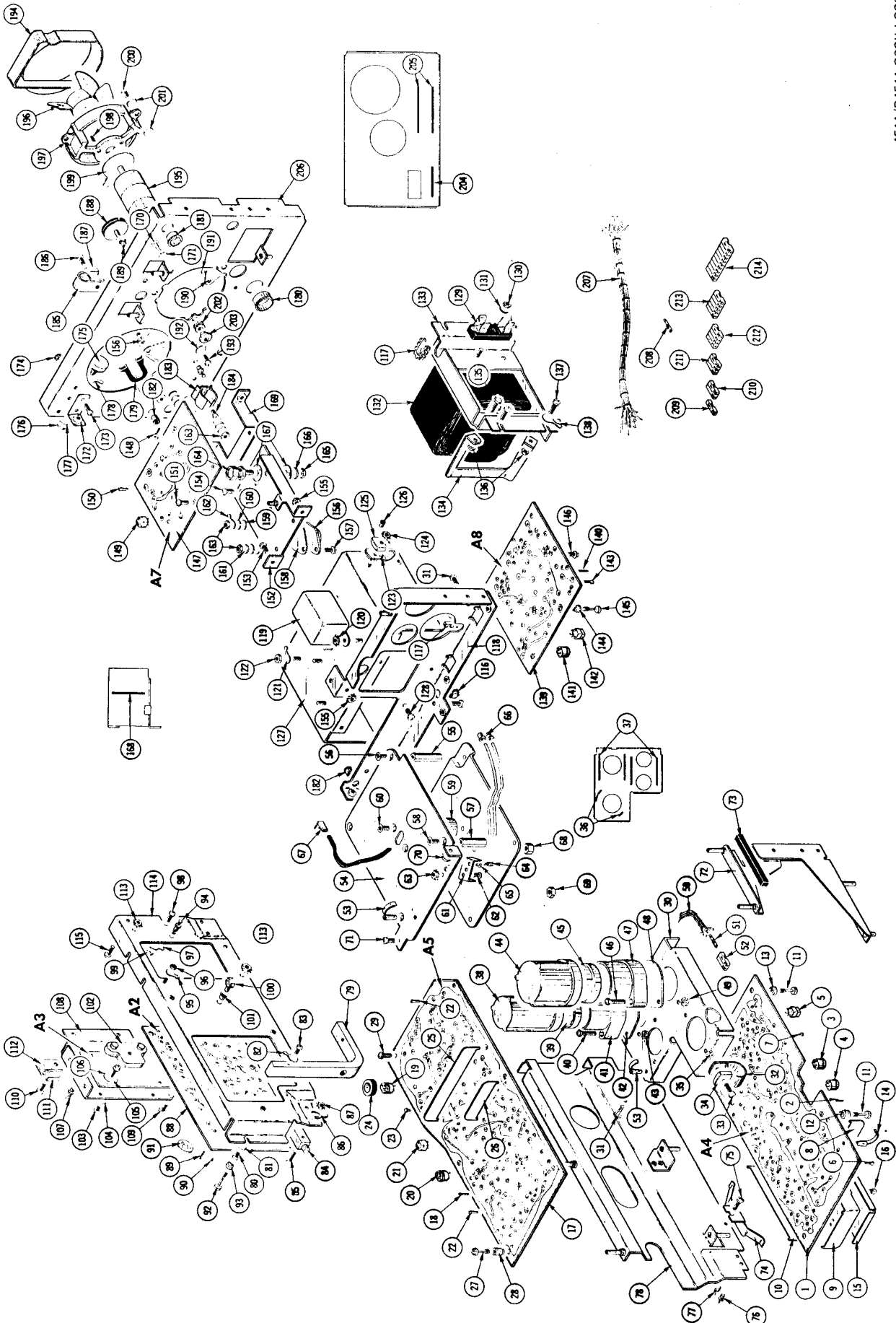

454A/R/454A OSCILLOSCOPE

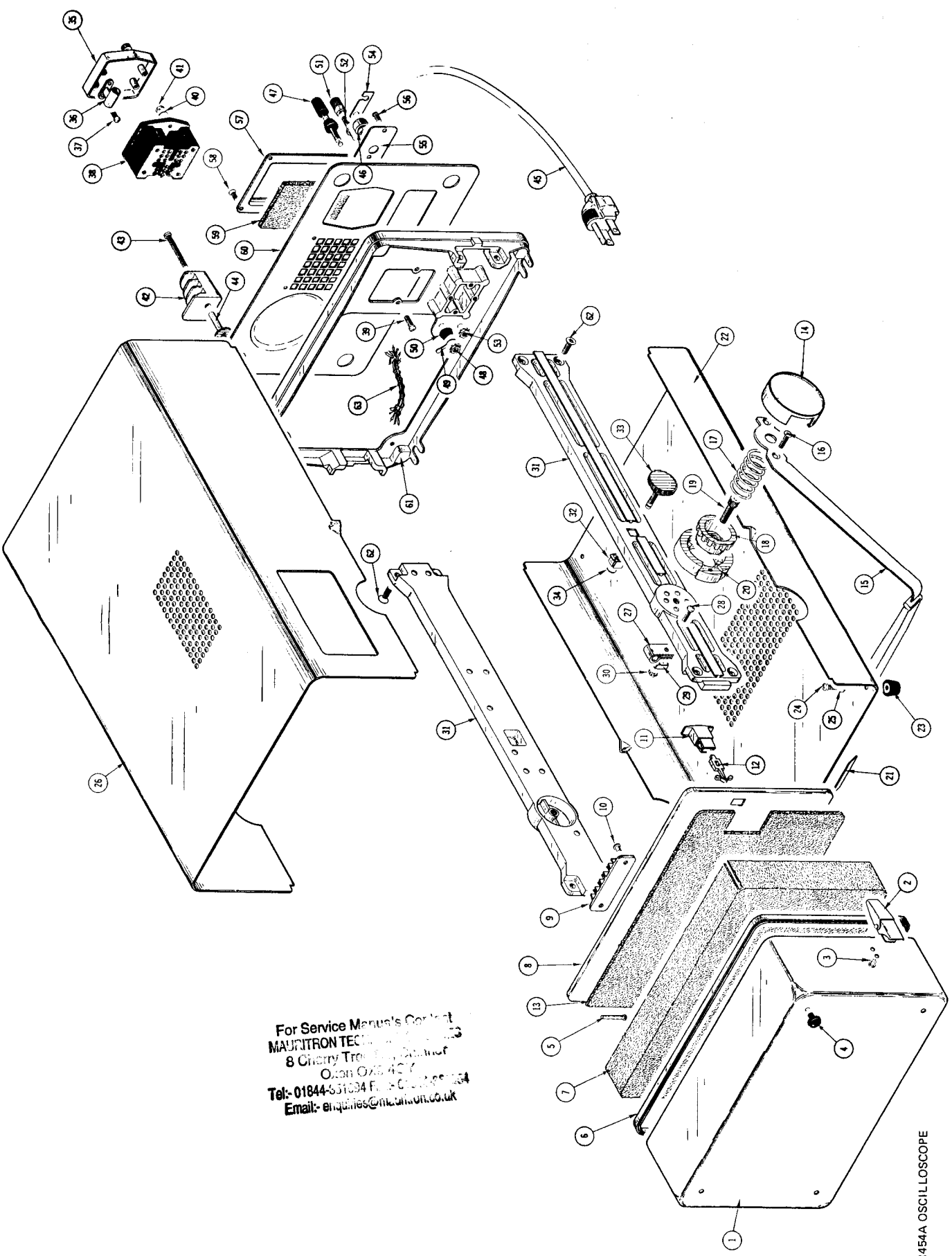

For Service Manuals Contact  
**MAURITRON TECHNIQUES LTD**  
 8 Cherry Tree Lane, Otterburn  
 Oxon OX5 4CJ  
 Tel: 01844-531034 Fax: 01844-531034  
 Email: enquiries@mauritron.co.uk

454A/R454A OSCILLOSCOPE

FIGURE 4 454A FRAME &amp; CABINET

Fig. & Index No.	Tektronix Part No.	Serial/Model No.		Q t y	Description
		Eff	Disc		
4-1	200-0633-01			1	COVER ASSEMBLY, front
	- - - - -			-	cover assembly includes:
-2	214-0531-01			2	LATCH ASSEMBLY
	- - - - -			-	mounting hardware for each: <i>(not included w/latch assembly)</i>
-3	210-0666-00			2	RIVET
-4	348-0013-00			4	FOOT, rubber
-5	214-0755-00			2	PIN, hinge, plastic
-6	252-0571-00			ft	EXTRUSION, plastic, 3 feet long
-7	348-0091-00			1	CUSHION, cover, bottom
-8	200-0710-00			1	DOOR, accessory storage
	- - - - -			-	door includes:
-9	352-0093-00			1	HOLDER, fuse, storage
	- - - - -			-	mounting hardware: <i>(not included w/holder)</i>
-10	210-0696-00			2	EYELET
-11	204-0282-00			1	BODY, latch
-12	214-0787-00			1	STEM, latch
-13	348-0118-00			1	PAD, cushion, door
-14	200-0602-00			2	COVER, handle latch
-15	367-0072-01			1	HANDLE, carrying
	- - - - -			-	mounting hardware: <i>(not included w/handle)</i>
-16	211-0512-00			4	SCREW, 6-32 x 0.50 inch, 100° csk, FHS
-17	214-0516-00			2	SPRING, handle index
-18	214-0578-00			2	HUB, handle index
	- - - - -			-	mounting hardware for each: <i>(not included w/hub)</i>
-19	213-0129-00			1	SCREW, hex., 0.25-20 x 0.75 inch, SHS
-20	214-0513-00			2	INDEX, handle ring
-21	334-1418-00			1	PLATE, identification
-22	386-1177-00			1	PLATE, cabinet bottom
	- - - - -			4	FOOT, cabinet
-23	348-0080-01			-	mounting hardware for each: <i>(not included w/foot)</i>
-24	211-0504-00			1	SCREW, 6-32 x 0.25 inch, PHS
-25	210-0005-00			1	WASHER, lock, external, 0.146 ID x 0.312 inch OD
-26	386-1178-00			1	PLATE, cabinet, top
-27	343-0004-00			1	CLAMP, cable, plastic, 0.312 inch diameter
	- - - - -			-	mounting hardware: <i>(not included w/clamp)</i>
-28	211-0511-00			1	SCREW, 6-32 x 0.375 inch, PHS
-29	210-0863-00			1	WASHER, "D" shape, 0.191 ID x 0.515 inch
-30	210-0457-00			1	NUT, keps, 6-32 x 0.312 inch

For Service Manuals Contact  
 MAURERON TECHNICAL SERVICES LTD  
 8 Cherry Tree Lane  
 Oxon OX0 40Y  
 Tel: 01844-831014 Fax: 01844-831015  
 Email: [enquiries@mauron.com](mailto:enquiries@mauron.com)



FIGURE 4 454A FRAME & CABINET (cont)

Fig. & Index No.	Tektronix Part No.	Serial/Model Eff	No. Disc	Q					Description
				y	1	2	3	4	
4-31	426-0260-00			2					FRAME, rail
-32	220-0439-00			-					each frame includes:
-33	214-0910-01			1					NUT, speed grip retainer, 0.25-20 inch
				2					SCREW, cabinet latch
-34	354-0175-00			-					mounting hardware for each: (not included w/screw)
				1					RING, retaining
-35	200-0704-00			1					COVER, line voltage selector
-36	352-0102-00			-					cover includes:
				2					HOLDER, fuse, plastic
-37	213-0035-00			-					mounting hardware for each: (not included w/holder)
-38	204-0279-00			2					SCREW, thread cutting, 4-40 x 0.25 inch, PHS
-39	211-0513-00			1					BODY, line voltage selector
-40	210-0006-00			-					mounting hardware: (not included w/body)
-41	210-0407-00			2					SCREW, 6-32 x 0.625 inch, PHS
				2					WASHER, lock, internal, 0.146 ID x 0.283 inch OD
				2					NUT, hex., 6-32 x 0.25 inch
-42	348-0258-00			4					FOOT, cabinet, w/cord wrap
-43	212-0022-00			-					mounting hardware for each: (not included w/foot)
-44	129-0294-00			1					SCREW, 8-32 x 1.50 inches, PHS
				1					POST, 0.188 ID x 0.26 OD x 1.03 inch long
-45	161-0033-07			1					CORD, power, 3 conductor
-46	358-0323-00			1					BUSHING, strain relief
-47	129-0064-00			1					POST, binding
-48	210-0457-00			-					mounting hardware: (not included w/post)
-49	210-0203-00			1					NUT, keps, 6-32 x 0.312 inch
-50	358-0181-00			1					LUG, solder, SE #6, long
				1					BUSHING, plastic
	129-0020-00			1					BINDING POST ASSEMBLY
-51	200-0072-00			-					binding post assembly includes:
-52	355-0503-00			1					CAP, binding post
				1					STEM, adapter
-53	220-0410-00			-					mounting hardware: (not included w/binding post assembly)
				1					NUT, keps, 10-32 x 0.375 inch
-54	346-0043-00			1					STRAP, ground
-55	386-1122-00			1					PLATE, power cord
-56	211-0504-00			-					mounting hardware: (not included w/plate)
				2					SCREW, 6-32 x 0.25 inch, PHS

For Service and Parts Contact  
 MAURICE J. ...  
 8 On ...  
 Tel: 01044-651 ...  
 Email: enquiries@...

FIGURE 4 454A FRAME & CABINET (cont)

Fig. & Index No.	Tektronix Part No.	Serial/Model No. Eff	No. Disc	Q					Description	
				y	1	2	3	4		5
4-57	380-0082-00			1						HOUSING, fan filter
-58	213-0107-00			-						mounting hardware: <i>(not included w/housing)</i>
				4						SCREW, thread forming, 4-40 x 0.25 inch, 100° csk, FHS
-59	378-0036-01			1						FILTER, air
-60	386-1880-00			1						PANEL, rear
-61	426-0317-01			1						SUBPANEL, rear
-62	212-0506-00			-						mounting hardware: <i>(not included w/subpanel)</i>
				4						SCREW, 10-32 x 0.375 inch, 100° csk, FHS
-63	179-1579-00			1						WIRING HARNESS, w/connectors, line voltage

For Service Manuals Contact  
**MAURITON TECHNOLOGIES**  
 8 Cherry Tree Lane  
 Oxon Hill, MD 20648  
 Tel: 01044-351234 Fax: 01044-351234  
 Email: enquiries@mauriton.com

FIGURE 5 R454A CABINET

Fig. & Index No.	Tektronix Part No.	Serial/Model Eff	No. Disc	Q					Description
				y	1	2	3	4	
5-1	426-0378-01			1					FRAME, front
-2	334-1120-04			1					PLATE, identification
-3	134-0067-00			4					PLUG, gray plastic
-4	367-0022-00			2					HANDLE
-5	213-0090-00			-					mounting hardware for each: <i>(not included w/handle)</i>
				2					SCREW, 10-32 x 0.50 inch, HHS
-6	386-1063-00			1					PLATE, front frame backing, top
-7	212-0002-00			-					mounting hardware: <i>(not included w/frame)</i>
				1					SCREW, 8-32 x 0.25 inch, 100° csk, FHS
-8	386-1062-00			1					PLATE, front frame backing, bottom
-9	212-0002-00			-					mounting hardware: <i>(not included w/plate)</i>
				1					SCREW, 8-32 x 0.25 inch, 100° csk, FHS
-10	390-0012-00			1					CABINET TOP
-11	212-0001-00			-					mounting hardware: <i>(not included w/cabinet top)</i>
-12	211-0502-00			2					SCREW, 8-32 x 0.25 inch, PHS
				1					SCREW, 6-32 x 0.188 inch, 100° csk, FHS
-13	390-0013-00			1					CABINET BOTTOM
-14	212-0001-00			-					mounting hardware: <i>(not included w/cabinet bottom)</i>
-15	211-0502-00			2					SCREW, 8-32 x 0.25 inch, PHS
				1					SCREW, 6-32 x 0.188 inch, 100° csk, FHS
-16	386-1261-00			1					PLATE, rear
-17	212-0010-00			-					mounting hardware: <i>(not included w/plate)</i>
				4					SCREW, 8-32 x 0.625 inch, PHS
-18	210-0808-00			1					WASHER, centering
-19	211-0507-00			-					mounting hardware: <i>(not included w/washer)</i>
-20	210-0457-00			1					SCREW, 6-32 x 0.312 inch, PHS
				1					NUT, keps, 6-32 x 0.312 inch
-21	386-1064-00			1					PLATE, side
-22	212-0023-00			-					mounting hardware: <i>(not included w/plate)</i>
-23	212-0040-00			1					SCREW, 8-32 x 0.375 inch, PHS
-24	212-0043-00			1					SCREW, 8-32 x 0.375 inch, 100° csk, FHS
-25	210-0458-00			4					SCREW, 8-32 x 0.50 inch, 100° csk, FHS
				6					NUT, keps, 8-32 x 0.344 inch
-26	426-0358-01			1					FRAME, support, right
-27	212-0040-00			-					mounting hardware: <i>(not included w/frame)</i>
-28	213-0129-00			4					SCREW, 8-32 x 0.375 inch, 100° csk, FHS
-29	361-0120-00			2					SCREW, 0.25-20 x 0.75 inch, HSS
				1					SPACER, stepped

FIGURE 5 R454A CABINET (cont)

Fig. & Index No.	Tektronix Part No.	Serial/Model No. Eff	No. Disc	Q					Description	
				t	y	1	2	3		4
5-30	426-0363-01			1						FRAME, support, left
	- - - - -			-						mounting hardware: <i>(not included w/frame)</i>
-31	212-0040-00			4						SCREW, 8-32 x 0.375 inch, 100° csk, FHS
-32	213-0129-00			2						SCREW, 0.25-20 x 0.75 inch, HSS
-33	361-0120-00			1						SPACER, stepped
-34	214-0881-00			1						HINGE
	- - - - -			-						mounting hardware: <i>(not included w/hinge)</i>
-35	211-0503-00			2						SCREW, 6-32 x 0.188 inch, PHS
-36	351-0104-00			1						GUIDE (pair), w/hardware
-37	355-0114-00			4						STUD
	- - - - -			-						mounting hardware for each: <i>(not included w/stud)</i>
-38	210-0411-00			1						NUT, hex., 0.25-20 x 0.438 inch
-39	210-0011-00			1						WASHER, lock, internal, 0.25 ID x 0.469 inch OD

For Service Manuals Contact  
**MAURITRON TECHNOLOGY CORP.**  
 8 Cherry Tree Rd., Cambridge, MA 02142  
 Tel: 617-552-1100  
 Fax: 617-552-1101

FIG. 5 R454A CABINET

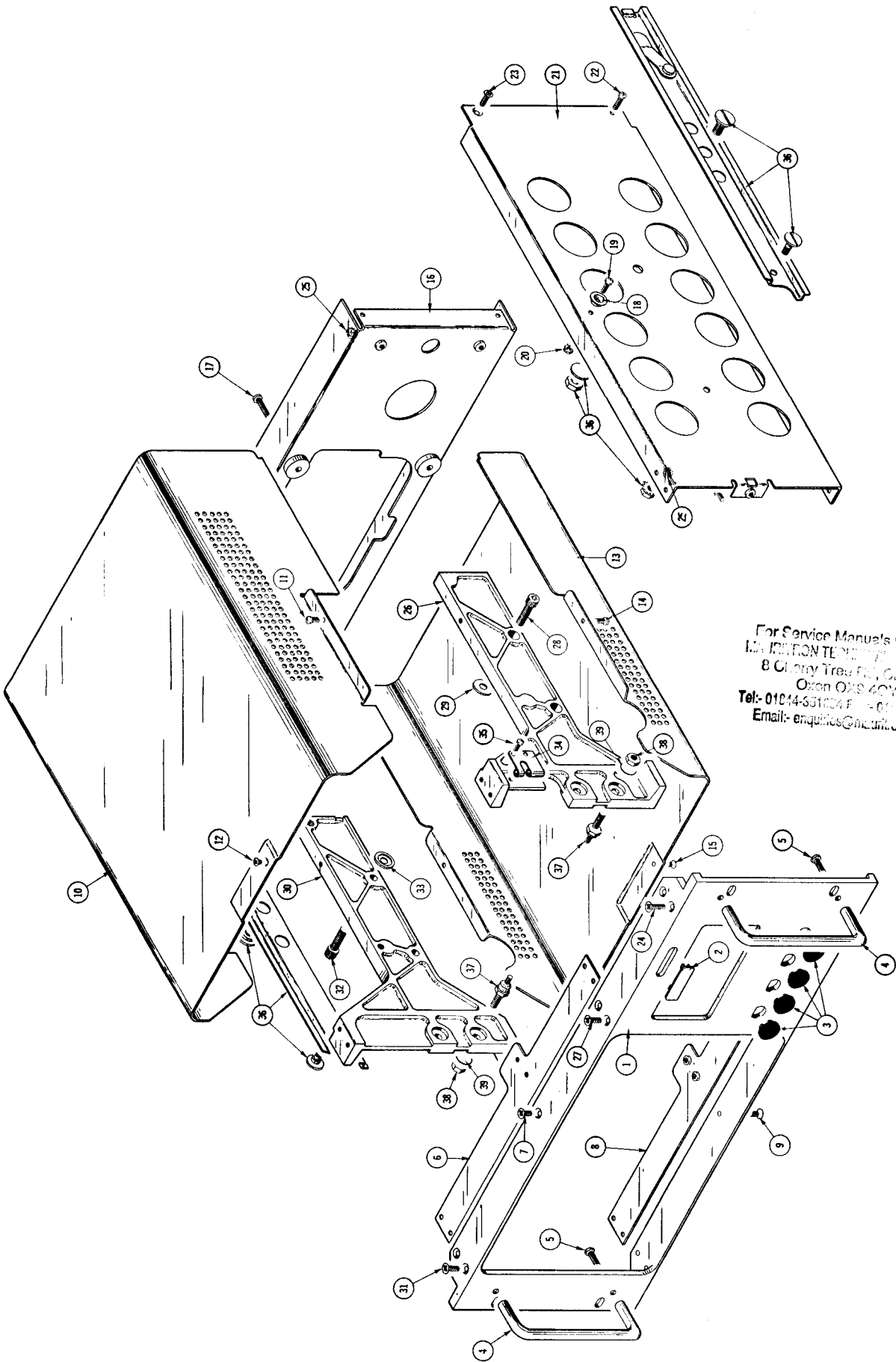

454A/R454A OSCILLOSCOPE

For Service Manuals Contact  
MILNITON TECHNICAL  
8 Cherry Tree Way, Gillingham  
Oxon OX8 4QY  
Tel: 01244-331004 Fax: 01244-350354  
Email: enquiries@milnorton.co.uk



For Service Manuals Contact  
 MAURITON TECHNICAL SERVICE  
 8 Clarendon Street, London W2 2EF

Total

Fig. & Index No.	Tektronix Part No.	Serial/Model No. Eff	Q					Description
			t	y	1	2	3	
6-1	010-6054-01						2	PROBE PACKAGE, P6054
-2	012-0076-00						1	CABLE, BNC to BNC 18 inches long
-3	012-0092-00						1	JACK, BNC-post
-4	159-0021-00						2	FUSE, fast blo, 2 amp, 3AG
	159-0022-00						1	FUSE, fast blo, 1 amp, 3AG
	159-0028-00						1	FUSE, fast blo, 1/4 amp, 3 AG
	070-1106-00						1	MANUAL, operators (not shown)
	070-1074-00						1	MANUAL, instruction (not shown)

OTHER PARTS FURNISHED WITH R454 ONLY

016-0096-00	1	KIT, ruggedizing hardware (not shown)
016-0099-00	1	KIT, rackmounting hardware (not shown)
351-0101-00	1 pr	TRACK, slide, stationary & intersection (not shown)

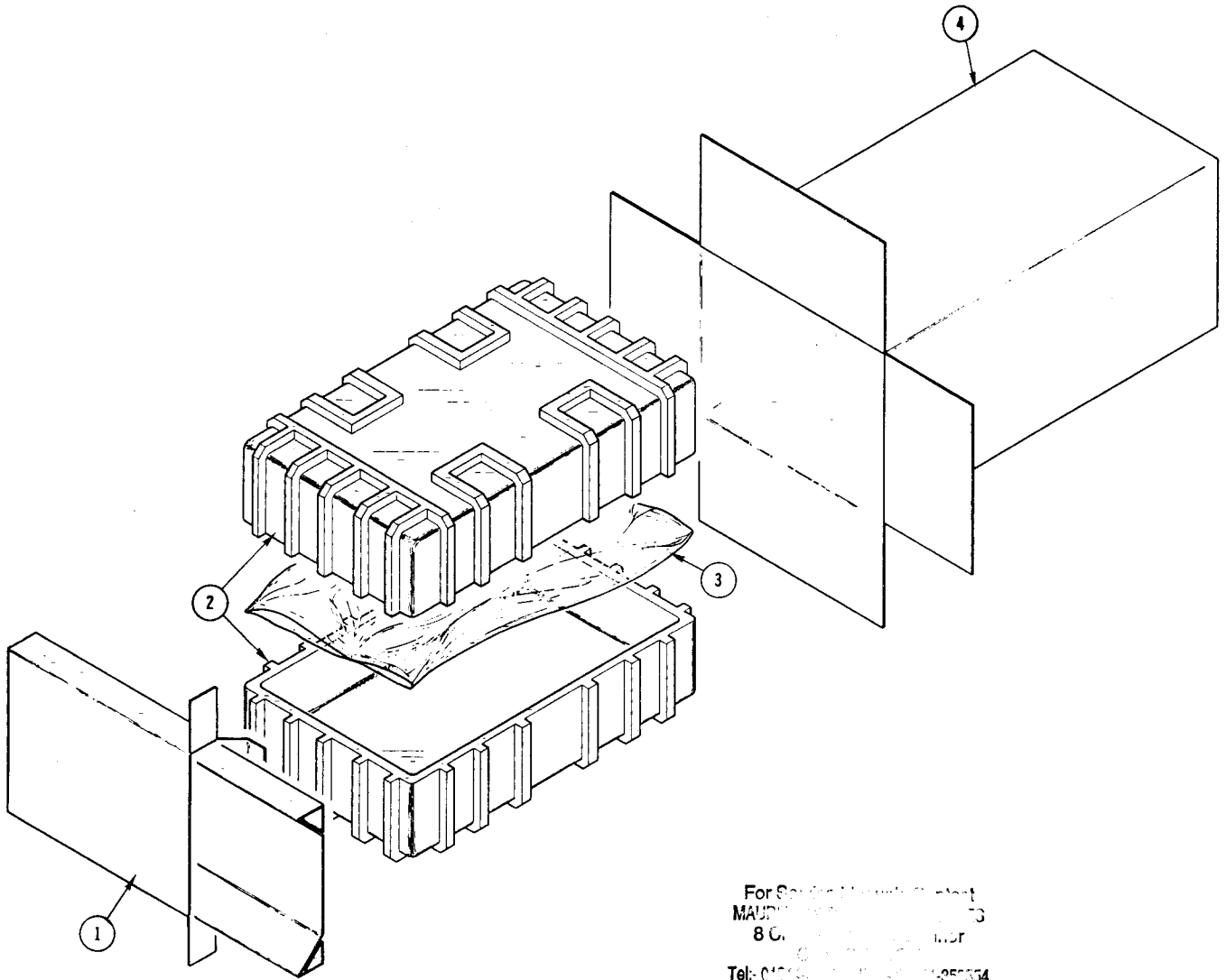

For Service Manuals, Contact  
 MAURICE WOODHEAD LTD  
 8 C. ...  
 Tel: 01262 ...  
 Email: ...@...co.uk

Fig. & Index No.	Tektronix Part No.	Serial/Model No. Eff	Model No. Disc	Q					Description	
				t	y	1	2	3		4
7-	065-0076-00			1						CARTON ASSEMBLY
-				-						carton assembly includes:
-1	004-0685-00			1						CARTON, accessory, w/pad
-2	004-0222-00			2						CASE HALF
-3	006-0342-00			1						BAG, plastic
-4	004-0679-00			1						CARTON

+ (A)

454A/R454A OSCILLOSCOPE

CARTON ASSEMBLY  
(Part No. 065-0101-00)

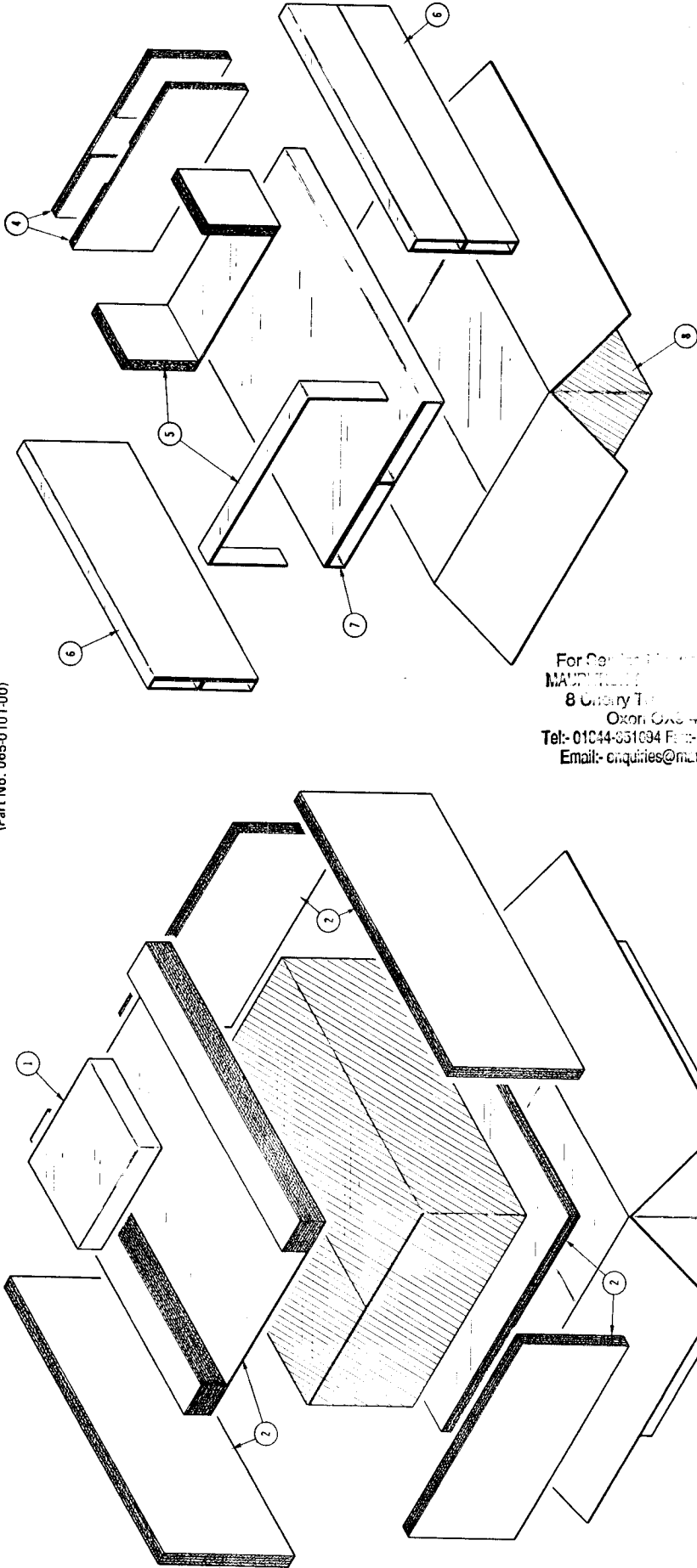

For Service Enquiries Contact  
MAURITON LTD  
8 Cherry Tree Lane  
Oxon OX2 4EY  
Tel: 01044-851634 Fax: 01044-957554  
Email: enquiries@mauriton.co.uk

Fig. & Index No.	Tektronix Part No.	Serial/Model No. Eff	Disc	Description											
				Q	Y	1	2	3	4	5					
8-	065-0101-00			1											CARTON ASSEMBLY
1	004-0704-00				1										carton assembly includes:
2	004-0361-00				1										CARTON, accessory
3	004-0461-00				1										PAD SET, 6 piece
4	004-0461-00				1										CARTON, outer
5	004-0566-00				2										PAD, and
6	004-0359-00				1										PAD SET, 2 piece
7	004-0360-00				1										PAD SET, side, 2 piece
8	004-0357-00				1										PAD, bottom
	004-0460-00				1										CARTON, inner

FIG. 8 R454A REPACKAGING